

DATA SHEET for LED DISPLAY

YDUG-2036K(A)M

Part No.	Dice Color
YDUG-2036K(A)M	Green
Color of Segment	Surface Color
White Diffused	Black
Internal Circuit Diagram	Package Dimensions

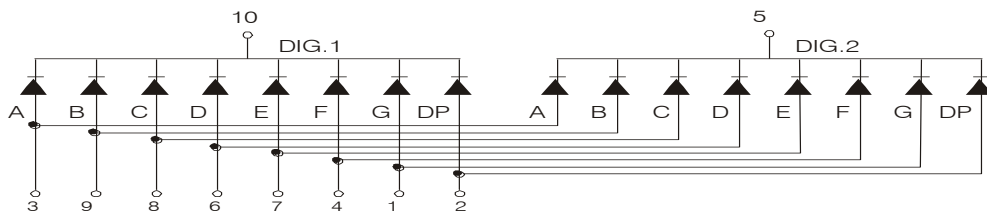
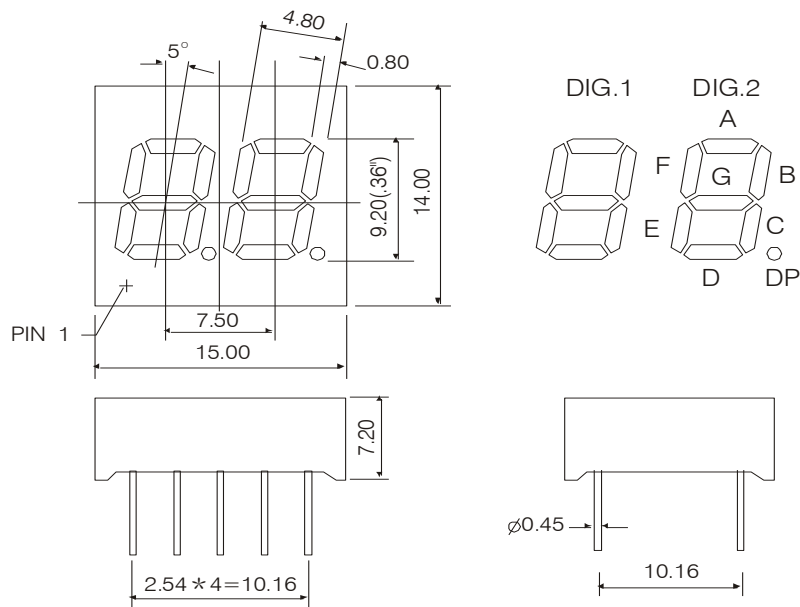

YDUG-2036KM

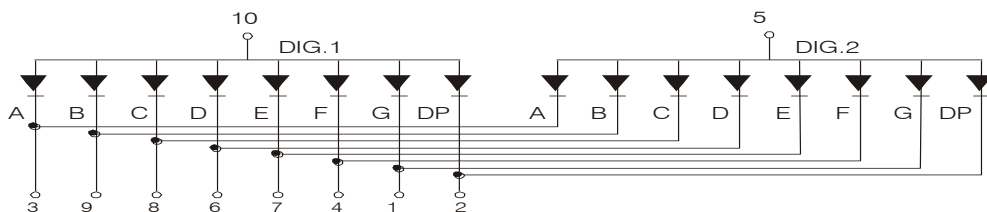

YDUG-2036AM

Absolute Maximum Rating of Each Segment (Ta=25°C)

Parameter	Symbol	Maximum Rating	Unit
Power Dissipation	P _M	80	mW
Continuous Forward Current	I _F	30	mA
Reverse Voltage	V _R	5	V
Operation Temperature	T _{opr}	- 20°C ~ 70°C	°C
Storage Temperature	T _{stg}	- 20°C ~ 85°C	°C

Electron-Optical Characteristics of Each Segment (Ta=25°C)

Parameter	Symbol	Min.	Typ.	Max.	Unit	Test Condition
Luminous Intensity	I _v	1.5	2.0		mcd	I _F =20mA
Forward Voltage	V _F		2.2	2.5	V	I _F =20mA
Reverse Current	I _R			20	μA	V _R =5V
Peak Wavelength	λ _p		570		nm	I _F =20mA