

DC Electronic Load

PEL-3000 Series

USER MANUAL

VERSION: 1.16



ISO-9001 CERTIFIED MANUFACTURER

GW INSTEK

This manual contains proprietary information, which is protected by copyright. All rights are reserved. No part of this manual may be photocopied, reproduced or translated to another language without prior written consent of Good Will company.

The information in this manual was correct at the time of printing. However, Good Will continues to improve products and reserves the rights to change specification, equipment, and maintenance procedures at any time without notice.

Good Will Instrument Co., Ltd.
No. 7-1, Jhongsing Rd., Tucheng Dist., New Taipei City 236, Taiwan.

Table of Contents

SAFETY INSTRUCTIONS	3
GETTING STARTED	8
PEL-3000 Series Introduction	10
Accessories	12
Appearance	15
First Time Use Instructions	24
OPERATION	50
Basic Operation	53
Basic Configuration	65
Advanced Configuration Settings	72
Step Resolution Configuration	80
Protection Settings	83
System Settings	89
Go-NoGo	92
Program	95
Sequence	103
Save Recall	122
EXTERNAL CONTROL	136
Analog Control	137
Parallel Operation	155
REMOTE CONTROL	162
Interface Configuration	163
FAQ	174
APPENDIX	176
Replacing the Dust Filter	178

Replace the Clock Battery	179
GPIB Installation.....	180
PEL-3000 Default Settings.....	181
Frame Control Connector Contacts	184
Operating Mode Description.....	189
Operating Area.....	194
PEL-3000 Specifications	198
PEL-3000 Dimensions	210
Declaration of Conformity	213
I NDEX.....	214

S SAFETY INSTRUCTIONS

This chapter contains important safety instructions that you must follow during operation and storage. Read the following before any operation to insure your safety and to keep the instrument in the best possible condition.

Safety Symbols

These safety symbols may appear in this manual or on the instrument.



WARNING

Warning: Identifies conditions or practices that could result in injury or loss of life.



CAUTION

Caution: Identifies conditions or practices that could result in damage to the instrument or to other properties.



DANGER High Voltage



Attention Refer to the Manual



Earth (ground) Terminal



Frame or Chassis Terminal



Do not dispose electronic equipment as unsorted municipal waste. Please use a separate collection facility or contact the supplier from which this instrument was purchased.

Safety Guidelines

General Guideline



CAUTION

- Do not place any heavy object on the instrument. Note: Only 2 units can be stacked vertically.
- Avoid severe impact or rough handling that leads to damaging the instrument.
- Do not discharge static electricity to the instrument.
- Use only crimped wires, not bare wires, for the terminals.
- Do not block the cooling fan opening.
- Do not disassemble the instrument unless you are qualified.
- The equipment is not for measurements performed for CAT II, III and IV.

(Measurement categories) EN 61010-1:2010 specifies the measurement categories and their requirements as follows. The instrument falls under category II.

- Measurement category IV is for measurement performed at the source of low-voltage installation.
 - Measurement category III is for measurement performed in the building installation.
 - Measurement category II is for measurement performed on the circuits directly connected to the low voltage installation.
 - Measurement category I is for measurements performed on circuits not directly connected to Mains.
-

Power Supply

**WARNING**

- AC Input voltage range:
100~120VAC/200~240VAC
(90~132VAC/180~250VAC)
 - Frequency: 47~63Hz
 - Power:
PEL-3021: 90VA Max
PEL-3041: 110VA Max
PEL-3111: 190VA Max
PEL-3211: 230VA Max
 - To avoid electrical shock connect the protective grounding conductor of the AC power cord to an earth ground.
-

Cleaning

- Disconnect the power cord before cleaning.
 - Use a soft cloth dampened in a solution of mild detergent and water. Do not spray any liquid.
 - Do not use chemicals containing harsh material such as benzene, toluene, xylene, and acetone.
-

Operation
Environment

- Location: Indoor, no direct sunlight, dust free, almost non-conductive pollution (Note below)
- Temperature: 0°C to 40°C
- Humidity: 0 to 85% RH

(Pollution Degree) EN 61010-1:2010 specifies the pollution degrees and their requirements as follows. The instrument falls under degree 2.

Pollution refers to “addition of foreign matter, solid, liquid, or gaseous (ionized gases), that may produce a reduction of dielectric strength or surface resistivity”.

- Pollution degree 1: No pollution or only dry, non-conductive pollution occurs. The pollution has no influence.
- Pollution degree 2: Normally only non-conductive pollution occurs. Occasionally, however, a temporary conductivity caused by condensation must be expected.
- Pollution degree 3: Conductive pollution occurs, or dry, non-conductive pollution occurs which becomes conductive due to condensation which is expected. In such conditions, equipment is normally protected against exposure to direct sunlight, precipitation, and full wind pressure, but neither temperature nor humidity is controlled.

Storage environment

- Location: Indoor
- Temperature: -20°C to 70°C
- Humidity: <90% RH

Disposal



Do not dispose this instrument as unsorted municipal waste. Please use a separate collection facility or contact the supplier from which this instrument was purchased. Please make sure discarded electrical waste is properly recycled to reduce environmental impact.

Power cord for the United Kingdom

When using the instrument in the United Kingdom, make sure the power cord meets the following safety instructions.

NOTE: This lead/appliance must only be wired by competent persons



WARNING: THIS APPLIANCE MUST BE EARTHED

IMPORTANT: The wires in this lead are coloured in accordance with the following code:

Green/ Yellow:	Earth
Blue:	Neutral
Brown:	Live (Phase)



As the colours of the wires in main leads may not correspond with the coloured marking identified in your plug/appliance, proceed as follows:

The wire which is coloured Green & Yellow must be connected to the Earth terminal marked with either the letter E, the earth symbol  or coloured Green/Green & Yellow.

The wire which is coloured Blue must be connected to the terminal which is marked with the letter N or coloured Blue or Black.

The wire which is coloured Brown must be connected to the terminal marked with the letter L or P or coloured Brown or Red.

If in doubt, consult the instructions provided with the equipment or contact the supplier.

This cable/appliance should be protected by a suitably rated and approved HBC mains fuse: refer to the rating information on the equipment and/or user instructions for details. As a guide, a cable of 0.75mm² should be protected by a 3A or 5A fuse. Larger conductors would normally require 13A types, depending on the connection method used.

Any exposed wiring from a cable, plug or connection that is engaged in a live socket is extremely hazardous. If a cable or plug is deemed hazardous, turn off the mains power and remove the cable, any fuses and fuse assemblies. All hazardous wiring must be immediately destroyed and replaced in accordance to the above standard.

GETTING STARTED

This chapter provides a brief overview of the PEL-3000, the package contents, instructions for first time use and an introduction to the front panel, rear panel and GUI.



PEL-3000 Series Introduction	10
Model Line Up	10
Main Features	11
 Accessories	 12
Package Contents	14
 Appearance	 15
PEL-3000 Front Panel	15
(PEL-3021/PEL-3041)	15
(PEL-3111)	15
(PEL-3211 Booster Pack)	16
Rear Panel	20
PEL-3021 / PEL-3041	20
(PEL-3111)	20

(PEL-3211 Booster Pack)	21
Display.....	23

First Time Use Instructions 24

Rack Mount Kits.....	24
Power Up and Self Test.....	27
Load Default Settings.....	28
Setting the Date and Time.....	28
Load Wiring.....	29
Load Wire Connections.....	32
Using the Front Panel Input Terminals.....	33
Using the Rear Panel Input Terminals.....	34
Using the Terminal Cover.....	35
Using the Terminal Cover (PEL-013).....	38
Remote Sense.....	40
Firmware Update.....	41
Conventions.....	43
Help Menu.....	49

PEL-3000 Series Introduction

The PEL-3000 Series is a family of high performance DC electronic loads positioned to test a wide range of different power sources. The DC electronic loads are fully programmable to simulate anything from basic static loads to complex dynamic loads. With the ability to operate independently or in parallel, the PEL-3000 Series is extremely robust and capable of molding to any test environment.

Please note that throughout this manual the term “PEL-3000” refers to any one of the models in the series lineup, unless specifically stated otherwise.

Model Line Up

There are a total of 3 DC electronic load models and 1 booster pack model.



Model	Operating Voltage (DC)	Current	Power
PEL-3021	1.5V~150V	35A	175W
PEL-3041	1.5V~150V	70A	350W
PEL-3111	1.5V~150V	210A	1050W

Booster Model	Operating Voltage (DC)	Current	Power
PEL-3211	1.5V~150V	420A	2100W

Main Features

Performance	<ul style="list-style-type: none">• High slew rates of up to 16A/μS(PEL-3111) for a fast response speed• High capacity when used in parallel: 5250W, 1050A (PEL-3111 x 5)/ 9450W, 1890A (PEL-3111 + PEL-3211 x 4)• High resolution - 16 bit
Features	<ul style="list-style-type: none">• 7 operating modes: CC, CV, CR, CP, CC+CV, CR+CV, CP+CV• Independent and parallel operation• Fully programmable with normal and fast sequences• Soft start• Dynamic mode• OCP, OVP and other protection features• Remote sense• Integrated meter• Rack-mountable• Load booster
Interface	<ul style="list-style-type: none">• USB, RS232 and GPIB• External voltage or resistance control• Front panel trigger out BNC• Front panel current monitoring BNC• Analog external control

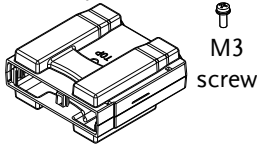
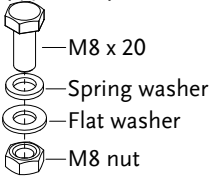
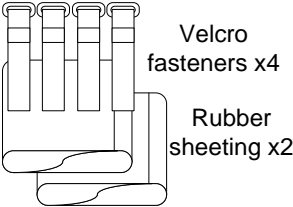
Accessories

Standard Accessories	Part number	Description
		Quick Start Guide
		User / Programming manual CD
	Region dependant	Power cord
	PEL-011	Load input terminal Cover 
	PEL-012	Terminal fittings: 2 sets of bolts/nuts/springs/washers (type: M8) 
	PEL-013	Flexible terminal cover: 2x rubber sheeting, 4x Velcro fasteners. (For PEL-3211 only) 
	PEL-014	J1/J2 Protection plug x2 

61SF-062104N1 Front terminal washers
—Spring washer (M6) x2

Optional Accessories	Part number	Description
	3813-030D0501	CR123A 3V lithium battery for clock.
	GRA-413	Rack mount bracket for booster PEL-3211 (EIA + JIS)
	GRA-414-E	Rack mount frame for PEL-3021, PEL-3041, PEL-3111/EIA
	GRA-414-J	Rack mount frame for PEL-3021, PEL-3041, PEL-3111/JIS
	GTL-255	300mm Frame Link Cable (for linking units that are stacked) Standard for the PEL-3111/3211.
	GTL-248	GPIB cable, 2.0m
	GTL-246	USB cable, Type A - Type B
	PEL-010	Dust Filter
Options	Part number	Description
	PEL-004	GPIB option

Package Contents

Check the contents before using the instrument.

Opening the box

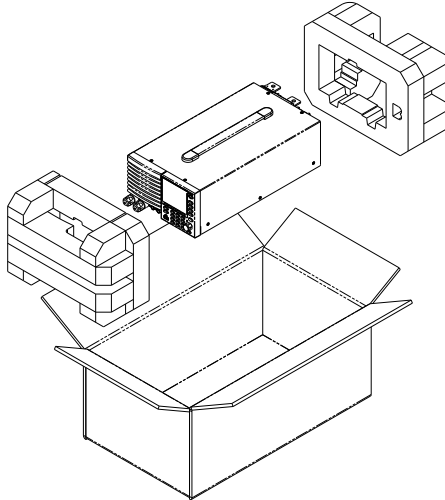

Contents (single unit)

- Main unit
- Quick Start manual
- User / Programming manual CD
- Terminal fittings
- Power cord x1 (region dependent)
- Calibration certificate

Appearance

PEL-3000 Front Panel

(PEL-3021/PEL-3041)

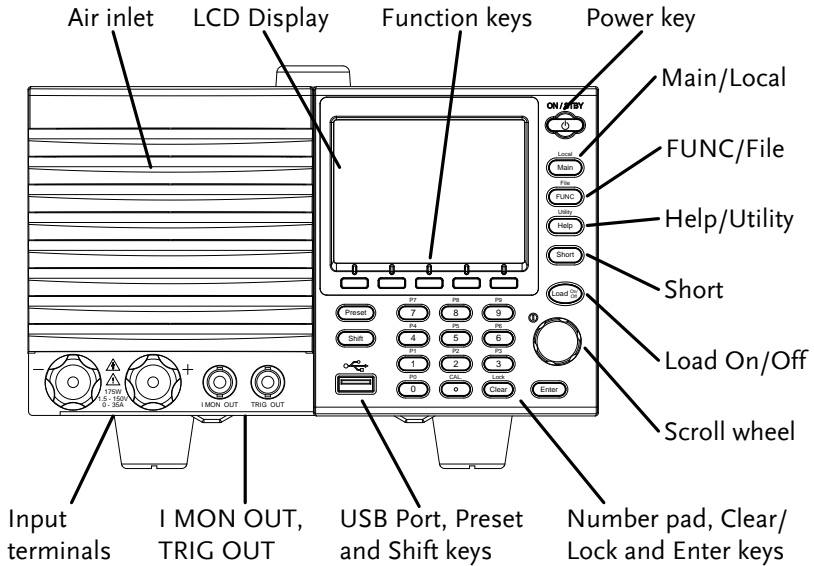

(PEL-3111)

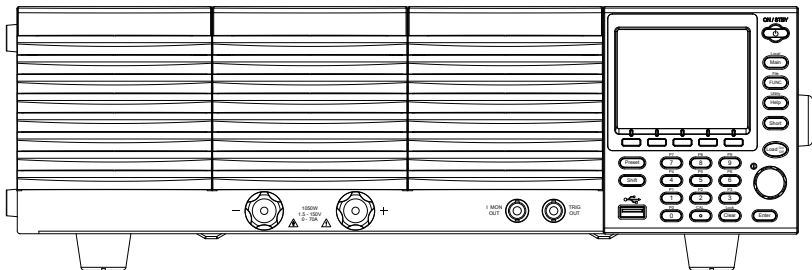

(PEL-3211 Booster Pack)

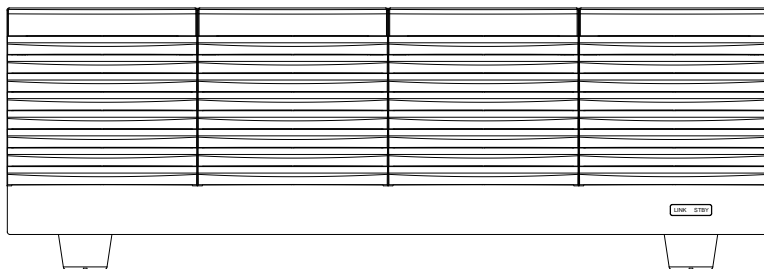



Air Inlet The air inlet has a removable dust filter



LCD display 3.5 inch LCD display

Function keys 





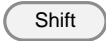



The function keys directly correspond to the soft menu keys at the bottom of the display.

ON/STBY  Turns the unit on or puts the unit into standby mode. Use the power switch on the rear panel to turn the unit off.

Main/Local  Main: Sets the operating mode: CC, CV, CR, CP mode.

 +  Local (Shift + Main): Puts the instrument back into local mode from remote mode.

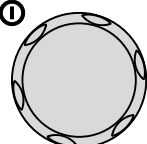
FUNC/File  FUNC: Sets the program function, sequence function or other special functions.

	 + 	File (Shift + FUNC): Accesses the file system.
Help/Utility		Help: Access the help menu.
	 + 	Utility (Shift + Help): Access the utility menu.
Short		Pressing the Short key will simulate shorting the input terminals. The Short key will be lit when active.
Load on/off		Turns the load on or off. The Load On/Off key will be lit when active.
Scroll wheel		Use the scroll wheel to navigate the menu system or to edit parameters. See page 43 for usage details.
Enter		Press the Enter key to select highlighted menu items.

Number pad

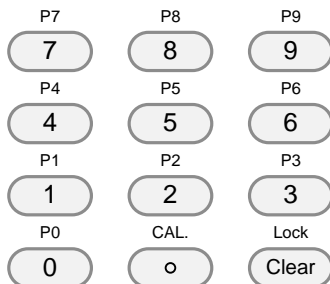

Number pad: Used to enter numerical values.

P0~P9 (Preset + Number keys): Loads one of 10 preset settings.

Clear/Lock



Clear: Clears the current parameter values.

Lock (Shift + Clear): Locks the front panel keys and selector knob.

Shift



Shift: Used in conjunction with other keys to select secondary functions.

Preset



Used in conjunction with the number pad to save or load preset settings P0 to P9.

USB Port

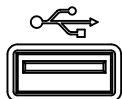

USB A port. Used for save and recall functions.

Front panel input terminals

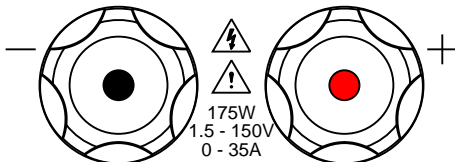

Negative terminal. Positive terminal.

IMON Out



IMON OUT

Current monitor BNC terminal:
Output connector used to monitor the current by outputting a voltage. An output voltage of 1V corresponds to the full scale current for the H and L ranges. 0.1V corresponds to the full scale current in the M range.

TRIG OUT



TRIG OUT

Trigger out BNC terminal:
Outputs a pulse signal during sequence or dynamic operation. The trigger signal has a 5V output with a pulse width of a least 2us and an impedance of 500Ω.

Rear Panel

PEL-3021 / PEL-3041

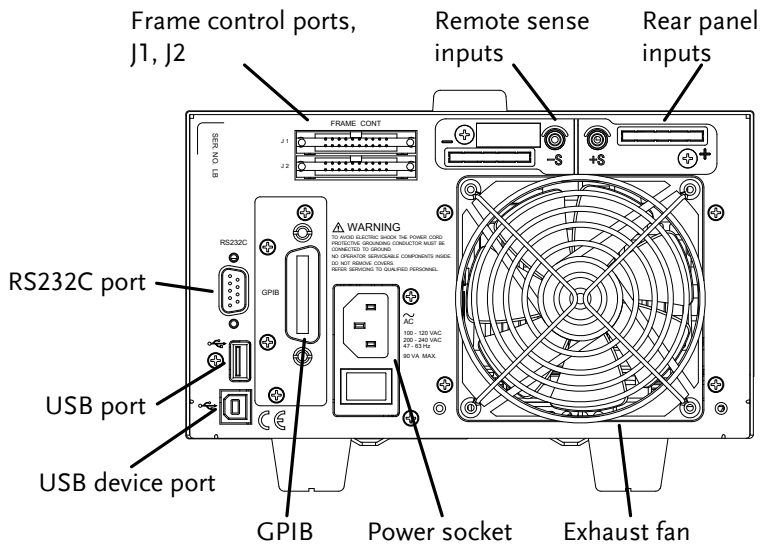

(PEL-3111)

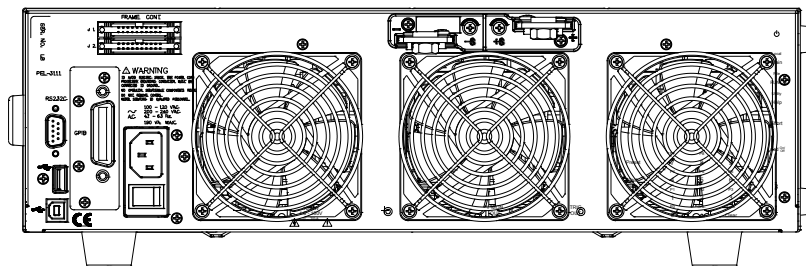

(PEL-3211 Booster Pack)

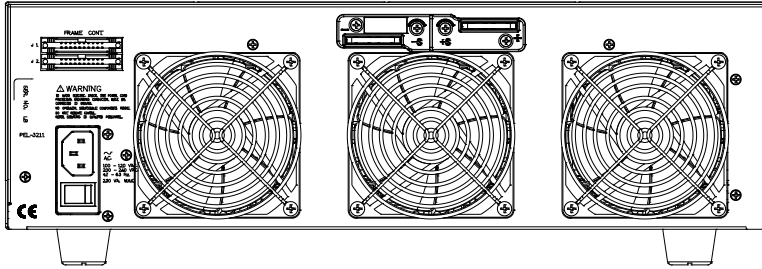

RS232C Port The USB B, RS232C and GPIB port are used for remote control.

GPIB

USB B

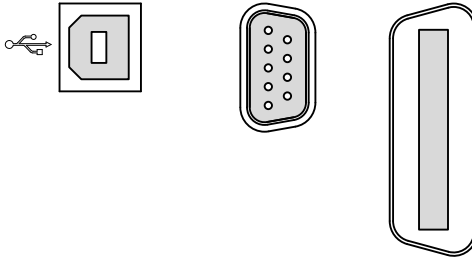

USB B port

RS232C 9 pin
DSUB port.

GPIB 24 pin
female.

Frame control
ports, J1, J2

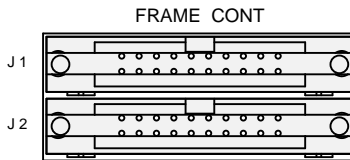

J1: The J1 connector is assigned to external control.

J2: The J2 connector is used for parallel operation control.

Exhaust fan The exhaust fan is used to expel the heat from the unit. Please ensure there is at least 20cm distance between any object and the fan.

Rear Panel Input terminals

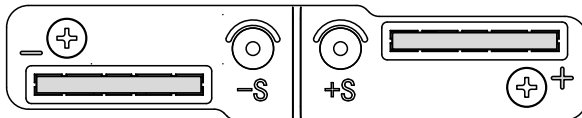

Rear Panel Input Terminals. Electrically connected to the front panel input terminals. Accepts M8 bolts or M4/M3 sized screws. See page 34 for connection details.

Remote Sensing Terminals

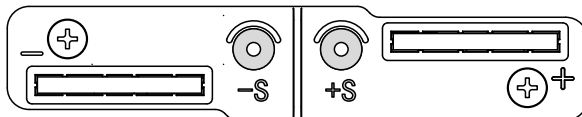

Sensing terminals for remote sense. See page 35.

Accepts M3 sized screws.

Power Socket

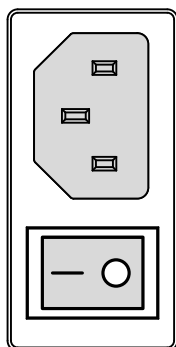

Power Socket:
100~120V, 200~240V
47~63Hz.

Power Switch

Turns the unit on/off.

USB A

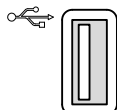

USB A Slave port. USB 1.1/2.0

Display

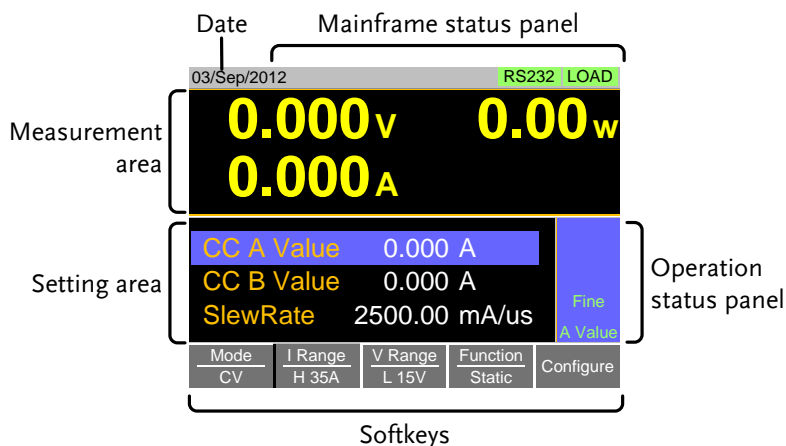

- Setting area** The setting area is used to display and edit the settings for the current mode/function.
- Measurement area** Displays the voltage, current and power values.
- Date** Displays the date.
- Mainframe status panel** The mainframe status panel displays the status of the load, remote control and short function.
- When an icon is green it indicates that the function is off. When the icon is orange, the function is on.
- Operation Status Panel** This status panel is used to display the status of the current mode.
- Soft-keys** The soft-key menus are used to select different functions or parameters.

First Time Use Instructions

Use the procedures below when first using the PEL-3000 to install the rack mount kit, power up the instrument, set the internal clock, restore the factory default settings and check the firmware version. Lastly, the Conventions section will introduce you to the basic operating conventions used throughout the user manual.

Rack Mount Kits

Description

The PEL-3000 has a number of rack mount options for installation. The GRA-413 rack mounts are suitable for the PEL-3211 booster pack. The GRA-414 rack mounts are capable of holding 1x PEL-3111 or 2x PEL-3021/3041 units.

For installation details, please see the GRA-413 and GRA-414 Rack Mount Assembly Manual.

Please see your distributor for which rack mount is suitable for your application.

GRA-413
(EIA standard)

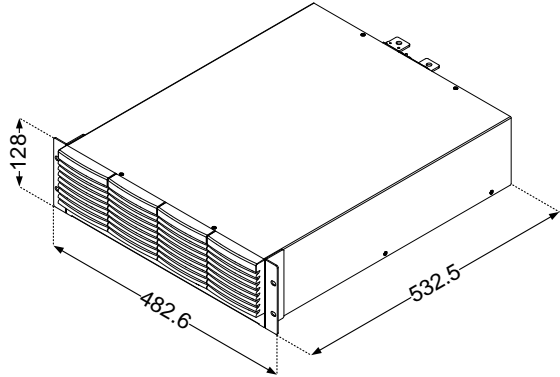

GRA-413
(JIS standard)

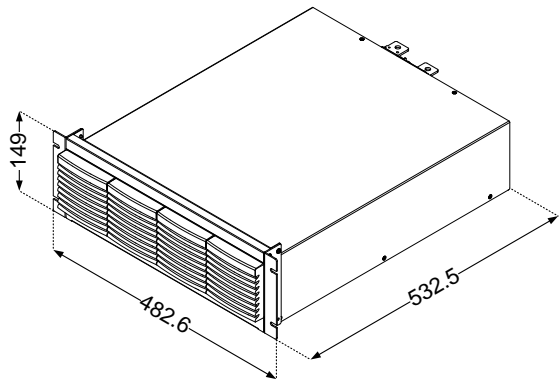
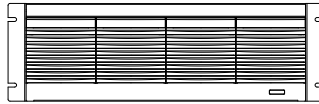

GRA-414-E
(EIA standard)

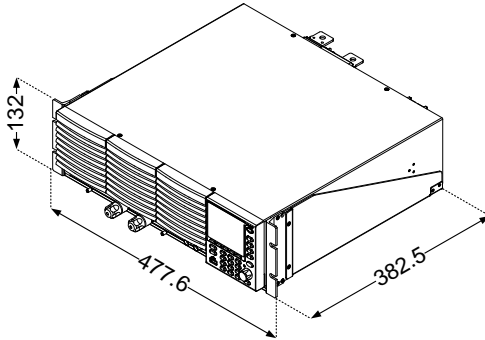
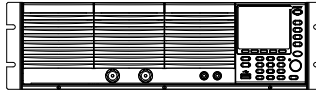

GRA-414-J
(IIS standard)

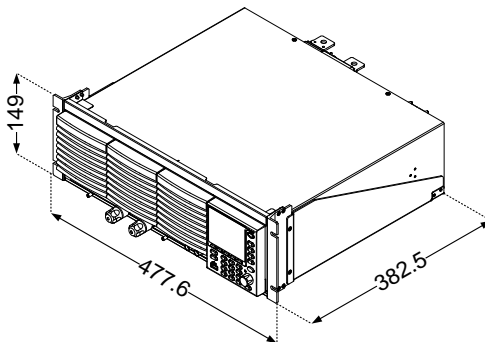
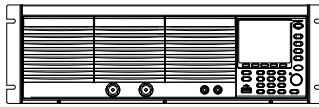

Power Up and Self Test

Steps

1. Insert the AC power cord into the power socket.

2. Turn the external power switch on.
(O → -)

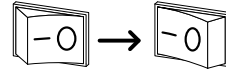

3. If the unit doesn't turn on, press the On/Standby key.
 - The ON/STBY key will go from standby (red) to on (green).

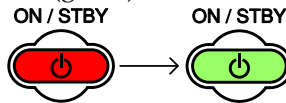

4. The unit will show the splash screen and then load the settings from when the unit was last powered down.



Note

If the PEL-3000 fails to start up properly or does not turn on, please see your local distributor.

Load Default Settings

Description When first using the PEL-3000, recall the factory default settings to ensure the unit is in a known state. See page 181 for a list of the default settings.

Operation

1. Press **Shift** + **File FUNC**.
 Select *Media/Default*[F1].
 Select *Factory Default*[F2].



Setting the Date and Time

Description The date and time settings are used to time-stamp files when saving files.

- The date is shown on top of the display.

Operation

1. Press **Shift** + **Utility Help** > *Time Set*[F4] to set the date and time.

Settings: Month, Day, Year, Hour, Minute

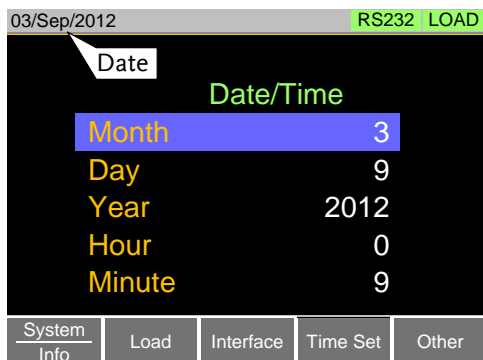

Load Wiring

Wire Gauge considerations

Before connecting the unit to a power source, the wire gauge must be taken into account. Load wires must be large enough to resist overheating when a short-circuit condition occurs as well as to maintain a good regulation. The size, polarity and length of a wire are all factors in determining if a wire will withstand short circuiting.

Wires that are selected must be large enough to withstand a short circuit and limit voltage drops to no more than 2V per wire. Use the table below to help make a suitable selection.

AWG Gauge	Conduct or Diameter mm	Ohms per km	Max amps for chassis wiring
0000	11.684	0.16072	380
000	10.4038	0.2027	328
00	9.26592	0.25551	283
0	8.25246	0.32242	245
1	7.34822	0.40639	211

2	6.54304	0.51266	181
3	5.82676	0.64616	158
4	5.18922	0.81508	135
5	4.62026	1.02762	118
6	4.1148	1.29593	101
7	3.66522	1.6341	89
8	3.2639	2.0605	73
9	2.90576	2.59809	64
10	2.58826	3.27639	55
11	2.30378	4.1328	47
12	2.05232	5.20864	41
13	1.8288	6.56984	35
14	1.62814	8.282	32

Load Line Inductance Considerations

When using the PEL-3000 load generator, voltage drop and voltage generated due to load line inductance and current change must be taken into account. Extreme changes in voltage may exceed the minimum or maximum voltage limits. Exceeding the maximum voltage limit may damage the PEL-3000.

To determine the voltage generated, the following equation can be used.

$$E = L \times (\Delta I / \Delta T)$$

E= voltage generated

L=load line inductance

ΔI = change of current (A)

ΔT = time (us)

Load line inductance (L) can be approximated as 1uH per 1 meter of wire. ($\Delta I / \Delta T$) is the slew rate in A/us.

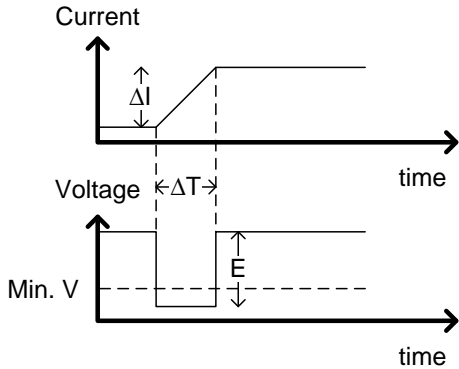

The diagram above shows how changes in current can affect voltage.

Limiting Load line inductance

Load line inductance can be reduced in two ways.

1. Ensure load wires are as short as possible and twist the positive and negative load wires together.
2. Current change can be limited by limiting the slew rate or response speed when switching in CR and CC mode.

“Twisted pair” will be shown on any connection diagram where the load wires should be twisted together.

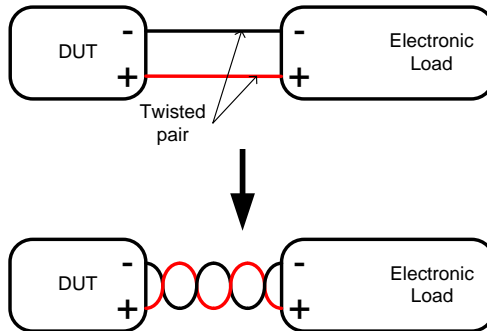

Load Wire Connections

Description The PEL-3000 has input terminals on both the front and rear panels.

Follow the procedures below for all load connections. Please adhere to the following precautions to ensure your safety and to protect the unit from damage.

Connection When connecting the PEL-3000 to the DUT, make sure that the polarity of the connection between the DUT and the unit matches.

Ensure that the maximum input voltage is not exceeded. The maximum input voltage is 150 volts.

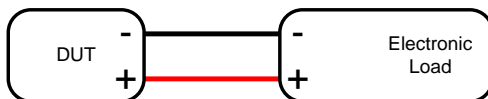

 **Caution**

If the polarity to the input terminals is reversed, the reverse voltage protection function is tripped. The reverse voltage protection function is tripped when reverse voltages greater than -0.3V are detected.

 **Warning**

Do not touch any of the input terminals when the unit is on.

 **Warning**

Connecting the input terminals to the wrong polarity can damage the DUT or the PEL-3000.

 **Warning**

The front panel and rear panel input terminals are physically connected. Any voltage that is input to one set of terminals will also appear on the other set of terminals.

Using the Front Panel Input Terminals

Description The front panel input terminals feature polarity-distinct caps and accept M6 sized crimped terminals.

 **Caution** The front panel input terminals on the PEL-3000 are physically connected to the rear panel terminals.

- Steps**
1. Turn the power off from the rear panel or put the unit into standby mode.
 2. Turn the power off from the DUT.
 3. Connect the load wires to the input terminals:
 - Connect the positive (+) input terminal on the load generator to the high potential output of the DUT.
 - Connect the negative (-) input terminal to the low potential output of the DUT.

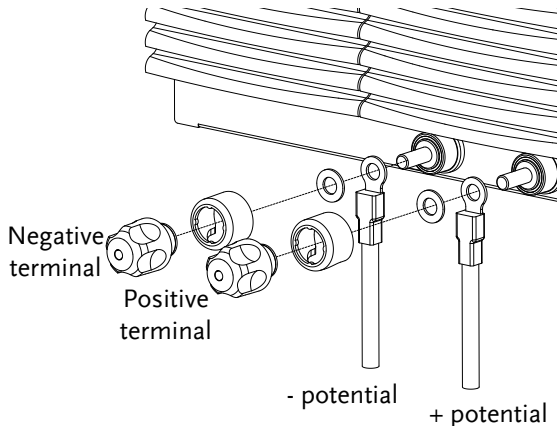

Using the Rear Panel Input Terminals

Description The rear panel input terminals accept up to M8-sized crimped terminals. The rear terminals come with a load input terminal cover for safety.



Caution

The front panel input terminals on the PEL-3000 are physically connected to the rear panel terminals.

- Steps**
1. Turn the power off from the rear panel or put the unit into standby mode.
 2. Turn the power off from the DUT.
 3. Connect the load wires to the input terminals:
 - Connect the positive (+) input terminal on the load generator to the high potential output of the DUT.
 - Connect the negative (-) input terminal to the low potential output of the DUT.

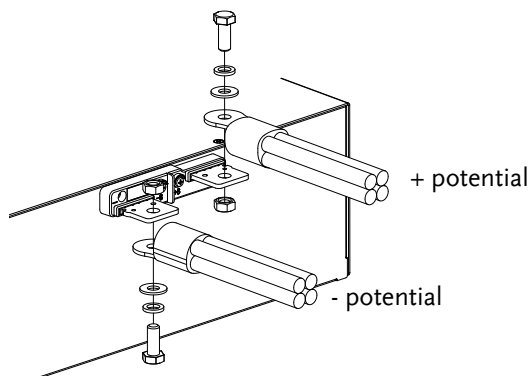

Using the Terminal Cover

Description	The rear panel terminal cover should be used to prevent electric shock. The rear panel terminal covers should always be used when connecting a load to the rear panel terminals. As the front panel and rear panel terminals are physically connected, the terminal cover should also be used as a safety measure when a DUT is connected to the front terminals
-------------	--



Caution

Ensure the power is off before making any connections to the PEL-3000.



Note

In the following diagrams, the cable wiring is not shown for clarity.

1. Remove the screw holding the top cover to the bottom cover.

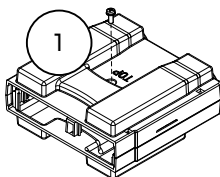

2. Line-up the bottom cover with the notches in the output terminals.
3. Place the top terminal cover over the bottom cover.

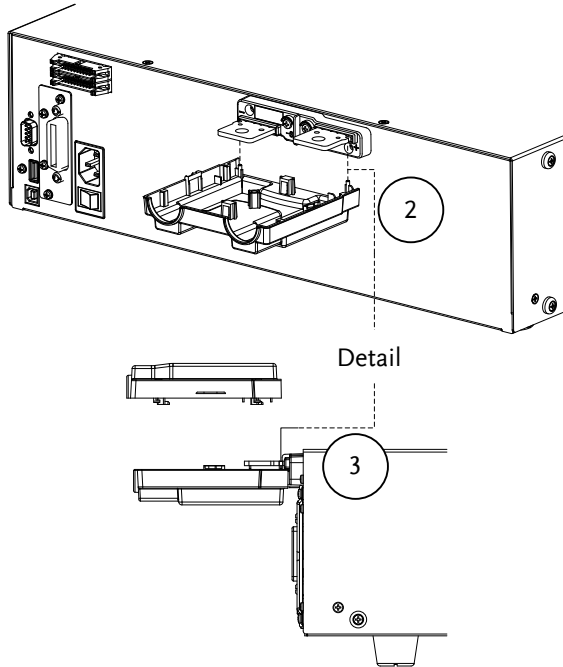

- 4. Use your thumb to slide the terminal covers shut, as shown in the diagram below.

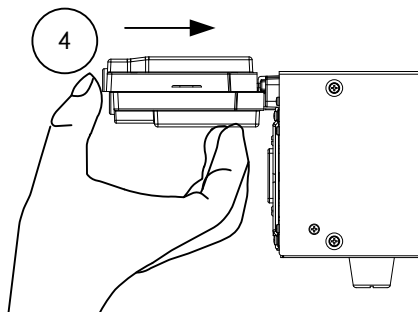

5. When the top and bottom covers are flush, reinsert the screw that was removed in step 1.

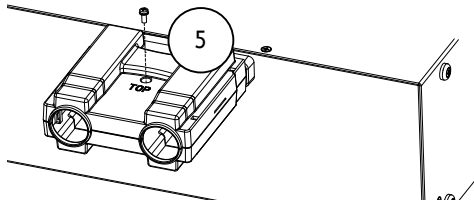

Using the Terminal Cover (PEL-013)

Description The flexible rear panel terminal cover should be used when the load wiring becomes too thick to be used with the PEL-012 terminal cover. This is especially true when using the load generators in parallel. Like the PEL-013 terminal cover, the PEL-012 is used to prevent electric shock. The rear panel terminal covers should always be used when connecting a load to the rear panel terminals.



Caution

Ensure the power is off before making any connections to the booster pack.

1. Wrap the insulation sheets around the terminals and load cables, as shown below. Make sure the terminals and any exposed wires are covered by the sheets.

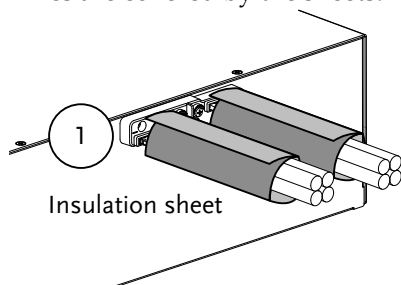

2. Secure the insulation sheets using the supplied velcro fasteners. 2 fasteners should be used for each sheet.

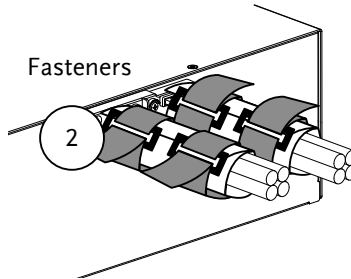



Remote Sense

Description Remote sense can be used to help compensate for long cable length. The longer the cable, the higher the potential resistance and inductance, therefore a short cable is best. Twisting the cable can help reduce induced inductance and using the Vsense terminals compensates the voltage drop seen across the load leads, especially leads with higher resistance. This is useful when used in CV, CR or CP mode.

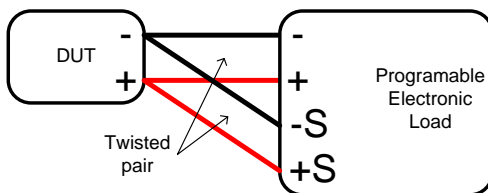

- Steps**
1. Turn the power off from the rear panel or put the unit into standby mode.
 2. Turn the power off from the DUT.
 3. Connect the sense wires to the sense terminals:
 - Connect the positive sense (+S) terminal to the high potential output of the DUT.
 - Connect the negative sense (-S) terminal to the low potential output of the DUT.

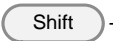

Firmware Update

Description	The PEL-3000 allows the firmware to be updated by end-users. Before using the PEL-3000, please check the GW Instek website or ask your local distributor for the latest firmware.
System version	Before updating the firmware, please check the firmware version.
Operation	<ol style="list-style-type: none">1. Press  + .2. Select <i>System/Info</i>[F1].3. The System information is listed on the display.<ul style="list-style-type: none">• Model: PEL-3000 model number.• Serial Number: XXXXXXXX• Firmware Ver.: Firmware version number.• Website address.4. To view other system information, press <i>System</i>[F1] and select <i>Memo</i>.

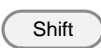

- Update Firmware
1. Insert a USB drive into the USB port. Ensure the USB drive has the firmware file located in the root directory.
 2. Press  +  .
 3. Select USB with the *Media*[F1] soft-key.
 4. Press the *File Utility*[F5] soft-key.
 5. Select the *.UPG upgrade file and press *Select*[F1] twice. Once to select the file and once to confirm.
 6. Wait for the update to complete and reset the power when prompted.

**Note**

Do not turn the load generator off or remove the USB memory when the firmware is being read or upgraded.

Conventions

The following conventions are used throughout the user manual. Read the conventions below for a basic grasp of how to operate the PEL-3000 menu system using the front panel keys.

Soft Menu keys

The F1 to F5 function keys at the bottom of the display correspond directly to the soft-menu keys on top.

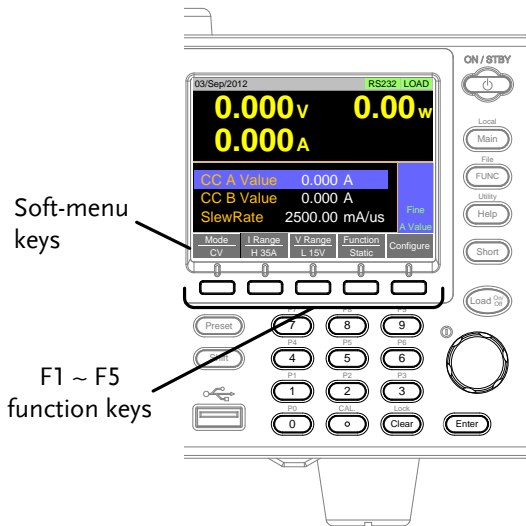

Select Sub Menu

Configure

Pressing this type of soft-menu key will enter a submenu.

Toggle Parameter or State

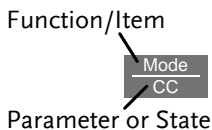

This type of soft-menu icon has the function/item on the top of the label and the selected setting or mode on the bottom of the label.

Repeatedly press the associated function key (F1~F5) to cycle through each setting. For example, repeatedly pressing the *Mode* soft-menu key will cycle through the CC, CR, CV and CP modes.

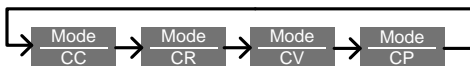

For some parameters, a popup window will also appear. Selection of the setting is the same. Repeatedly pressing the relevant function key (F1~F5) will cycle through each setting. The selection on the popup window will also be reflected on the label.

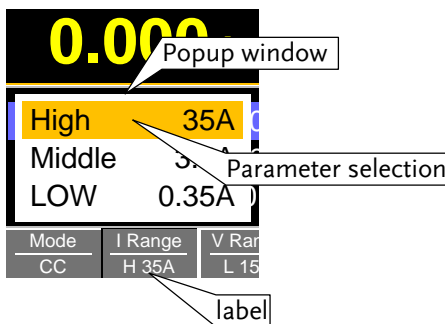

Parameter Input

The scroll wheel, Enter key and number pad can be used to edit parameter values.

Number pad

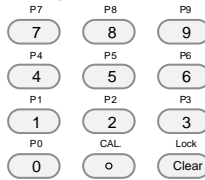

Scroll wheel



Enter key

1. Use the scroll wheel to move the cursor to the desired parameter.
- A scroll bar is shown when there are additional parameters off-screen.

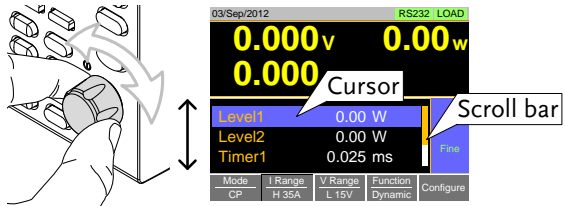

2. Press the Enter key to select the parameter. The parameter will become highlighted in white.

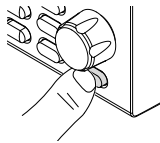

- Then use the number pad* or scroll wheel** to edit the parameter value.

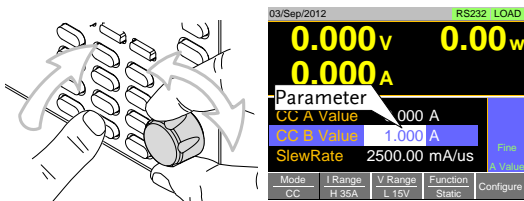

- Press the Enter key again to finish editing the parameter value.

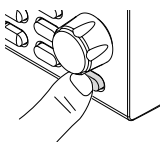

Clearing a Value*

*When editing a parameter with the number pad, pressing the **Clear** key will restore the parameter to the previous value.

Using the Scroll Wheel to Edit a Parameter**

**To edit a parameter using the scroll wheel, simply turn the scroll wheel. Clockwise increases the value, counterclockwise decrease the value.

Pressing the scroll wheel when a parameter is highlighted allows you to change the step resolution. There are two different step resolution methods: Step Mode and Cursor Mode.

Step Mode: This is the default step resolution method and will only be available to use when it is applicable (Indicated by *Fine* or *Coarse* in the Operation Status panel).

When a parameter is highlighted (step 3 above) pressing the scroll wheel will toggle the step resolution between fine and coarse. For details on how to set the step resolution, see page 81.



Cursor Mode: This method must first be enabled before it can be used. Pressing the scroll wheel when a parameter is highlighted allows you to set the step resolution by a digit value. An orange line will appear under the currently selected digit value. Repeatedly pressing the scroll wheel moves to the next digit. See page 80 for details.

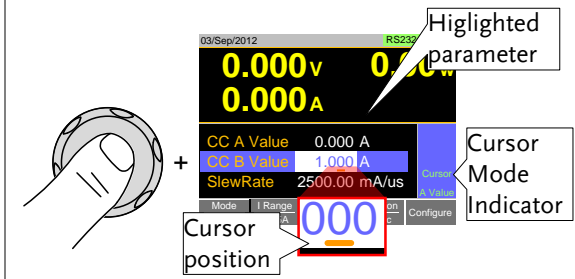

Entering Alphanumeric Characters

When renaming files, creating memos or notes, you will be required to enter alphanumeric characters when the character entry screen appears.

- Only alphanumeric characters as well as space [], underscore [_] and minus [-] characters allowed.
1. Use the scroll wheel to move the cursor to the desired character.

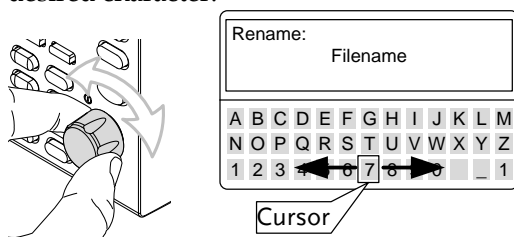

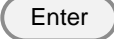
2. Press the  key or *Enter Character*[F1] to select a character.

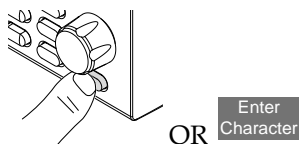

3. To delete a character, press *Back Space*[F2].
4. To save the file name or memo, press *Save*[F3].

Help Menu

When any function key has been pressed or when a menu has been opened, the HELP key can be used to display a detailed description.

- Help Selection
1. Press any function key or soft-menu key.
 2. Press  to see the help contents on that particular function key or menu.
 3. Use the scroll to navigate the help contents.
 4. Press the *Exit[F5]* key to exit the help menu.



OPERATION

Basic Operation	53
CC Mode.....	53
CR Mode.....	55
CR Units.....	57
CV Mode.....	57
CP Mode.....	58
+CV Mode.....	60
Turning on the Load	61
Shorting the Load	62
Short Key Configuration.....	63
Locking the Front Panel Controls.....	63
Basic Configuration	65
Select the Switching Function.....	65
Select the Display Units for Dynamic Mode Levels.....	67
Select the Switching Time Configuration for Dynamic Mode.....	69
Slew Rate.....	69
CV Mode Response Speed	70
CC, CR and CP Mode Response Speed.....	71
Advanced Configuration Settings	72
Soft Start Setting.....	72
Von Voltage Settings.....	73
Von Voltage Level.....	73
Von Voltage Latch.....	74
Von Voltage Delay.....	75
Timer Functions.....	75
Count Time.....	75
Cut Off Time	76
Auto Load Configuration	77
Load Off (Mode) and Load Off (Range).....	78
Safety Short.....	79

Step Resolution Configuration	80
Cursor Mode Configuration	80
Step Mode Configuration	81
Protection Settings.....	83
OCP.....	83
OPP.....	84
UVP.....	85
OVP.....	86
UnReg.....	87
Para.....	88
System Settings	89
Sound Settings.....	89
Speaker Settings.....	89
Alarm Tone Settings	90
Display Settings.....	90
Contrast and Brightness	90
Control Settings	91
Language Settings	91
Go-NoGo	92
Setting the Go-NoGo Limits	92
Running a Go-NoGo Test	93
Program.....	95
Program Overview.....	95
Create a Program	97
Create a Program Chain.....	100
Running a Program or Chain	101
Sequence	103
Normal Sequence Overview.....	103
Timing Edit Configuration	107
Data Edit Configuration.....	109
Running a Normal Sequence.....	111
Fast Sequence Overview.....	113
Timing Edit Configuration	117
Data Edit Configuration.....	118
Running a Fast Sequence.....	120

Save Recall	122
File Structure.....	122
File Types	123
Saving Files to Internal Memory	124
Saving Files to USB Memory.....	126
Recalling Files from Internal Memory.....	128
Recalling Files from USB Memory	129
Recall Memory Safety Setting	131
File Utility	132
Preset.....	133
Quick Preset Save.....	133
Quick Preset Recall.....	134
Default Settings.....	134
Factory Default Settings.....	134
User's Default Setting.....	135

Basic Operation

The PEL-3000 supports 7 main operating modes:

CC, CC+CV;

CR, CR+CV;

CV;

CP, CP+CV

CC Mode

Description	In Constant Current Mode the load units will sink the amount of current programmed. Regardless of the voltage, the current will stay the same. For more details on CC mode, please see the Appendix on page 189.
-------------	--



Warning

If you change the mode or the range when the load is already on, the load will be turned off automatically.

- | | |
|-----------|---|
| Operation | <ol style="list-style-type: none"> 1. Make sure the load is off. 2. Press . 3. Select CC mode with the <i>Mode[F1]</i> soft-key. 4. Select the current range with the <i>I Range[F2]</i> soft-key.
Range: High, Middle, Low 5. Select the voltage range with the <i>V Range[F3]</i> soft-key.
Range: High, Low |
|-----------|---|

6. Set the current level parameters using the scroll wheel and number pad.
 - For Static mode, set *CC A Value* and/or *CC B Value*.
 - For Dynamic mode, set *Level1* and *Level2*.
 - The maximum and minimum current levels depend on the selected ranges.
7. To add CV mode to CC mode (CC+CV), see page 60.
8. Set the remaining basic configuration settings such as the slew rate, and switching mode settings. See page 65 for details.

Display

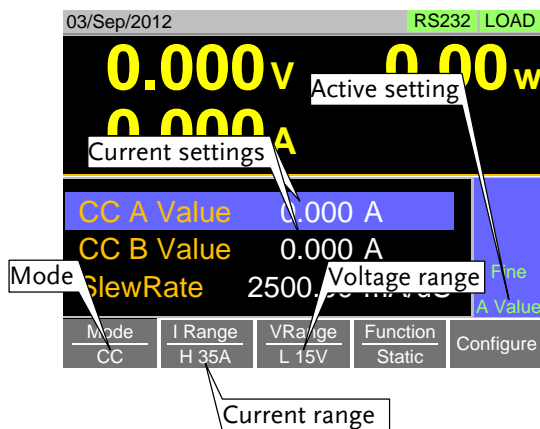

 Note

Basic CC mode configuration is complete. See page 65 for more configuration options.

The current range and voltage range applies to all the operating modes.

CR Mode

Description In Constant Resistance Mode, the unit will maintain a constant resistive load by varying the current. CR mode uses ohms, Ω (resistance) or siemens, S (conductance) for the setting units. For more details on CR mode, see the appendix on page 190.



Warning

If you change the mode or the range when the load is already on, the load will be turned off automatically.

- Operation**
1. Make sure the load is off.
 2. Press .
 3. Select CR mode with the *Mode[F1]* soft-key.
 4. Select the current range with the *I Range[F2]* soft-key.
Range: High, Middle, Low
 5. Select the voltage range with the *V Range[F3]* soft-key.
Range: High, Low

6. Set the resistance or conductance level parameters using the scroll wheel and number pad.
 - For Static mode, set *CR A Value* and/or *CR B Value*.
 - For Dynamic mode, set *Level1* and *Level2*.
 - The maximum and minimum conductance/resistance levels depend on the selected current range.
7. To add CV mode to CR mode (CR+CV), see page 60.
8. Set the remaining basic configuration settings such as the slew rate, and switching mode settings. See page 65 for details.

Display

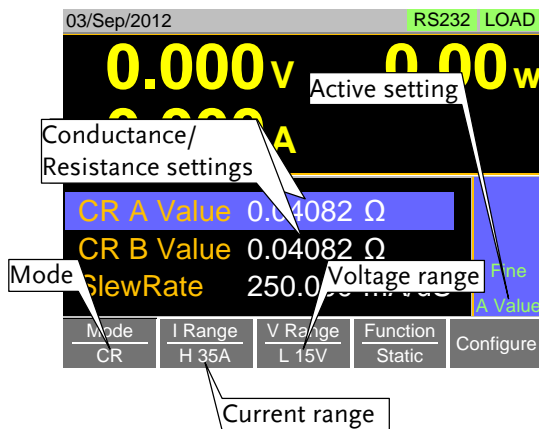

 **Note**

Basic CR mode configuration is complete. See page 65 for more configuration options.

The current range and voltage range applies to all the operating modes.

CR Units

Description The CR setting units can be set to ohm (Ω) or millisiemens (mS).

Operation

1. Make sure the load is off.
2. Press  > *Configure*[F5] > *Other*[F2] and set the *CR Unit* setting.
Range: Ω , mS

CV Mode

Description In Constant Voltage Mode, the unit will maintain a constant voltage. In CV mode you set the constant voltage level. For more details on CV mode, see the appendix on page 193.

 **Warning** If you change the mode or the range when the load is already on, the load will be turned off automatically.

Operation

1. Make sure the load is off.
2. Press .
3. Select CV mode with the *Mode*[F1] soft-key.
4. Select the current range with the *I Range*[F2] soft-key.
Range: High, Middle, Low
5. Select the voltage range with the *V Range*[F3] soft-key.
Range: High, Low

6. Set the voltage level parameters using the scroll wheel and number pad.
 - Set CV A Value and/or CV B Value.
 - The maximum and minimum voltage levels depend on the selected voltage range.

7. Set the remaining basic configuration settings such as the response settings. See page 65 for details.

Display

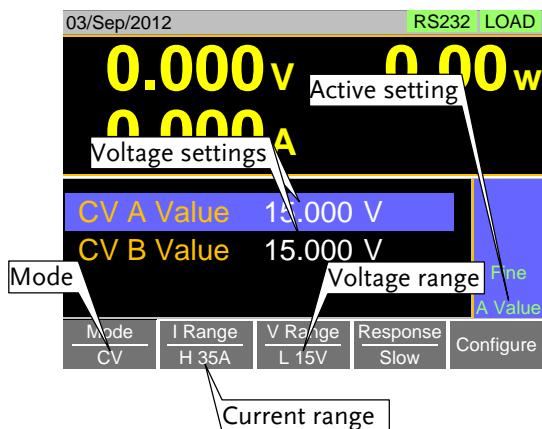

 Note

Basic CV mode configuration is complete. See page 65 for more configuration options.

The current range and voltage range applies to all the operating modes.

CP Mode

Description

In Constant Power Mode, the unit will maintain a constant power by varying the current. For more details on CP mode, see the appendix on page 191.



Warning

If you change the mode or the range when the load is already on, the load will be turned off automatically.

Operation

1. Make sure the load is off.
2. Press  .
3. Select CP mode with the *Mode[F1]* soft-key.
4. Select the current range with the *I Range[F2]* soft-key.
Range: High, Middle, Low
5. Select the voltage range with the *V Range[F3]* soft-key.
Range: High, Low
6. Set the power level parameters using the scroll wheel and number pad.
 - For Static mode, set *CP A Value* and/or *CP B Value*.
 - For Dynamic mode, set *Level1* and *Level2*.
 - The maximum and minimum power levels depend on the selected current range.
 - For static mode, the parameter that is set last becomes the “active” setting. This will be shown in the Operation Status Panel.
7. To add CV mode to CP mode (CP+CV), see page 60.
8. Set the remaining basic configuration settings such as the slew rate, and timer settings. See page 65 for details.

Display

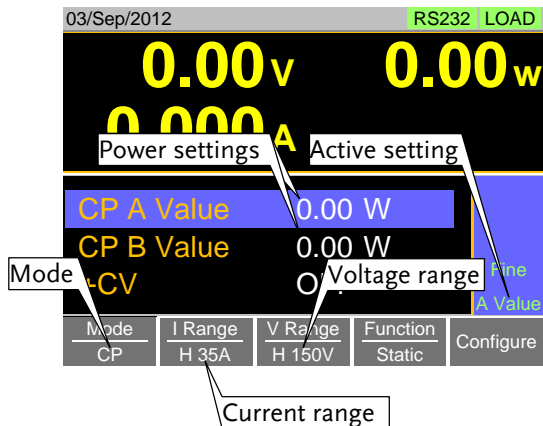

Basic CP mode configuration is complete. See page 65 for more configuration options.

The current range and voltage range applies to all the operating modes.

+CV Mode

Description

CV mode can be added to CC, CR and CP mode.

- The +CV settings apply to all applicable modes.

Operation

1. Make sure the load is off.
2. Press **Main** to return to the main menu for the current mode.
3. Set the +CV voltage level. (You may need to scroll down to the +CV setting)
Range: OFF ~ rated voltage+5%

Display

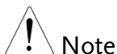
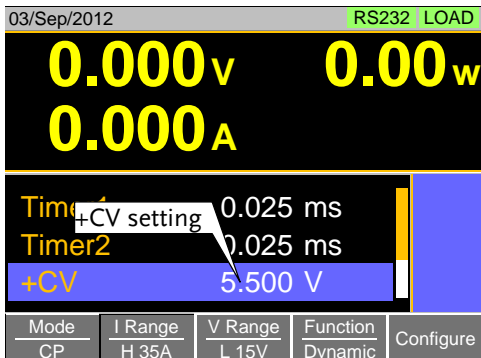

Note

The +CV settings apply to all the applicable operating modes.

For example: The +CV settings made in CR mode will be carried over to the +CV settings in CC and CP mode.

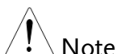



Note

+CV settings cannot be controlled with external control.

Turning on the Load

Description

- The load can be turned on and off by pressing the  key.
 - The  key will turn orange when the load is "on".
 - The LOAD icon in the Main Frame status panel will turn orange when the load is on.



Note

- The load can be set to automatically turn on at start up. See page 77.
- The load can be turned on via remote control. See the programming manual.
- The load can be turned on via external control. See page 146.
- By default the load will automatically turn off if the range or operating mode (CC, CV, CR, CP) is changed. To disable this behavior, Set *Load Off (Mode)* and *Load Off (Range)* to the *OFF* setting. See page 78 for details.

Display





Shorting the Load

Description

The Short key can be used to simulate a short circuit of the load input terminals. A short circuit is simulated by:

- Setting the current to the maximum value in CC mode.
- Setting the resistance to the minimum value in CR mode.
- Setting the voltage to the minimum value in CV mode.
- Setting the power to the maximum value in CP mode.
- When the load is shorted, the external controller also sends a short signal. See page 152 for usage details.

- Operation
- The short function can be turned on and off by pressing the  key.
 - The  key will turn red when the short function is active.
 - The Short icon will appear when the short function is active.
- Range: Toggle, Hold

Display

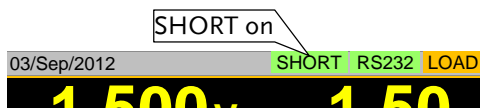

Short Key Configuration



- Description
- The Short key can be configured to Toggle or Hold. By Default the Short key is set to Toggle.
- Toggle: Pressing the Short key will toggle the shorting function on or off.
 - Hold: Holding the short key will short the load.

- Operation
- Press  > *Configure*[F5] > *Other*[F2] and set the *Short Key* setting.
- Range: Toggle, Hold

Locking the Front Panel Controls

- Description
- The keys and scroll wheel on the front panel can be locked to prevent settings from being changed.

Operation

1. The keys can be locked and unlocked by pressing  +  .
 - LOCK will appear in the Mainframe status panel when the keys are locked.
 - The  key will not be locked if the load is on.

Display

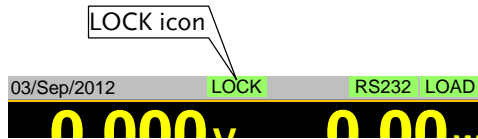

Basic Configuration

The basic configuration settings are the common configuration settings that are used for each operating mode. After selecting a basic operating mode (CC, CR, CV or CP mode), the slew rate, switching mode, response rate and other common parameters should be configured.

Select the Switching Function

Description The PEL-3000 has two switching modes, static and dynamic. The switching modes allow the PEL-3000 to switch between two preset levels. Static mode can only switch between the two levels manually, while Dynamic mode switches between each level automatically based on a timer.

- Static mode: A Value, B Value
- Dynamic mode: Level1, Level2

When the unit is set to static mode, only one value (A Value or B Value) can be active at a time. The active value is shown in the Operation Status Panel.

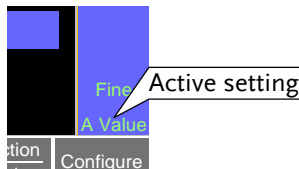

When the unit is set to dynamic mode, the unit will switch between Level1 and Level2 based on the Timer1 and Timer2 parameters, shown below.

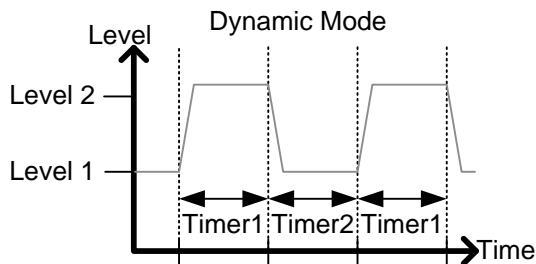

Note

Dynamic mode is not available for CV mode.

Operation

1. Make sure the load is off.
2. Press **Main**.
3. Select Dynamic or Static mode with the *Function[F4]* soft-key.
 - A different switching mode can be set for CC, CR and CP mode.
4. For dynamic mode, set the Timer1 and Timer2 parameters using the scroll wheel and number pad.
 - Timer1 sets the Level1 on-time.
 - Timer2 sets the Level2 on-time.
 - Take the slew rate settings into consideration when setting the timers.
 - The frequency of the dynamic switching is output via the TRIG OUT BNC.
 - To select whether A Value or B Value is the “active” setting, press the **Shift** + **Preset** keys.
 - The “active” value will be shown in the Operation Status Panel.

- The load can be “on” when switching between A Value and B Value.

Display:
Static Mode

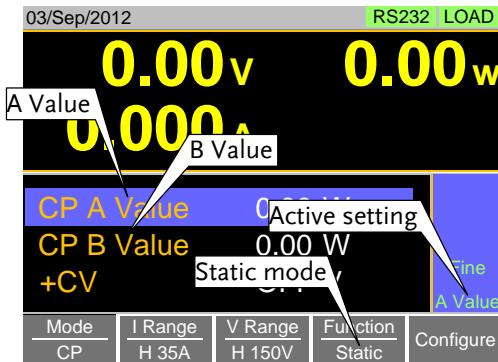

Display:
Dynamic Mode

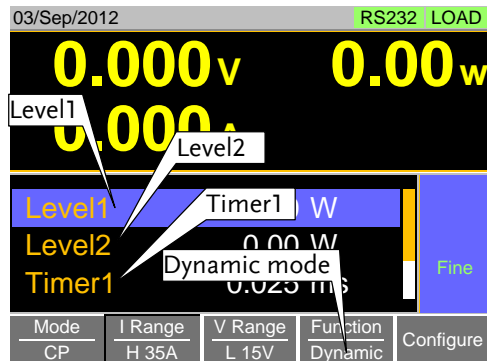

Select the Display Units for Dynamic Mode Levels

Description	<p>When Dynamic switching mode is selected, the Level1 and Level2 values can be set to either discrete values or as a percentage of a set value.</p> <ul style="list-style-type: none"> • The setting applies to all applicable operation modes. • By default the units are set to Value. • When Percent is chosen, 100% = 100% of the Set power, current or resistance value.
-------------	---

Operation

1. Make sure the load is off.
2. Press **Main** > *Configure*[F5] > *Other*[F2] and set the *Dyna. Level* setting.
Range: Value, Percent

Display:
Percent Setting

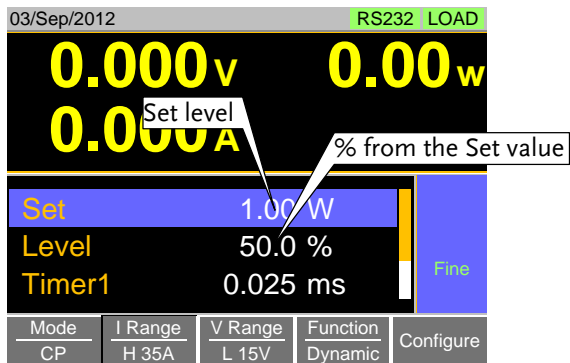

Example

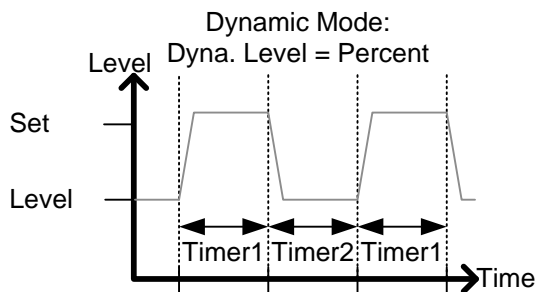

Select the Switching Time Configuration for Dynamic Mode

Description The switching time for dynamic mode can be configured to switch between two preset on-times (Timer1, Timer2) or by setting a switching frequency and duty cycle.

Operation 1. Press  > *Configure*[F5] > *Other*[F2] and set the *Dyna. Time* setting.
Range: T1/T2, Freq. Duty

Slew Rate

Description The current slew rate can be set for CC and CR mode. The slew rate setting is used to limit the change in current when switching.

For static mode, only a single slew rate can be set.

Operation 1. Make sure the load is off.

2. Press .

3. Set the slew rate(s) using the scroll wheel and number pad.

- For static mode, only a single slew rate can be set.
- For dynamic mode, set both the rising and falling slew rates.
- Take the timer settings into consideration when setting the slew rates.

Display

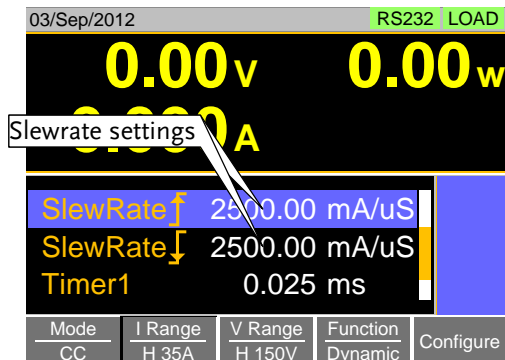

CV Mode Response Speed

Description

The response speed setting is the response speed for the negative feedback control of the load current when used in CV mode. Response speed settings are only applicable to CV mode.

- A response speed that is too fast could cause the unit to be unstable.
- Reducing the response speed can improve stability.

Operation

1. Make sure the load is off.
2. Press **Main**. Make sure the unit is in CV mode by using the *Mode[F1]* soft-key.
3. Select the response speed with the *Response[F4]* soft-key.
Range: Slow, Fast

Display

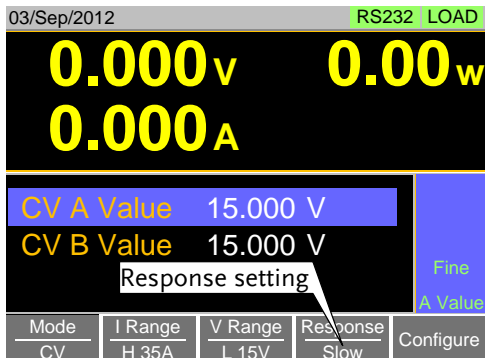

CC, CR and CP Mode Response Speed

Description

By default, the “normal current response” speed is set to 1/1. The response speed can be reduced to 1/2, 1/5, 1/10.

- Reducing the current response speed can affect other settings such as the slew rate and soft start settings.

Operation

1. Make sure the load is off.
2. Press **Main** > *Configure*[F5] > *Other*[F2] and set the *Response* parameter.
Range: $\frac{1}{1}$, $\frac{1}{2}$, $\frac{1}{5}$, $\frac{1}{10}$

Advanced Configuration Settings

Use the advanced configuration settings to configure settings other than those described in the basic configuration chapter.

Soft Start Setting

Description The soft start setting is used to limit the amount of input current at start-up or from when the Von Voltage threshold is tripped.

- The soft start setting only applies to CC, CR and CP mode.

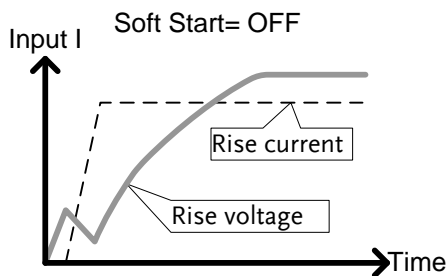
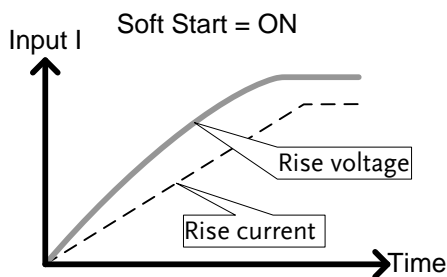

- Operation**
1. Press **Main** > *Configure*[F5] > *Other*[F2] and set the *Soft Start* time.
Range: OFF, 1~200ms

Von Voltage Settings

Von Voltage Level

Description The Von Voltage is the threshold voltage at which the load module will start to sink current.

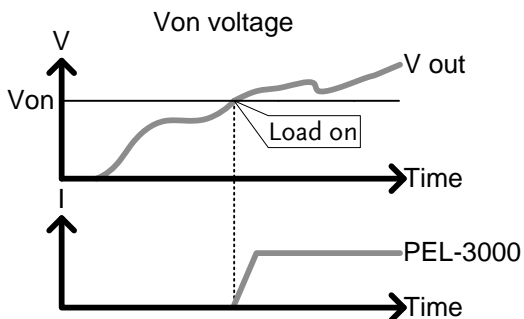

Operation

1. Press **Main** > *Configure*[F5] > *Other*[F2] and set the *Von Voltage* level.
Range: Von Voltage: 0.00~rating voltage

Von Voltage Latch

Description

When Von Latch is set to ON, the load will continue to sink current after being “latched”, even if the voltage drops below the Von Voltage threshold level.

When Von Latch is set to OFF, the load will turn off when the voltage drops below the Von Voltage threshold level.

- By default Von Latch is set to OFF.

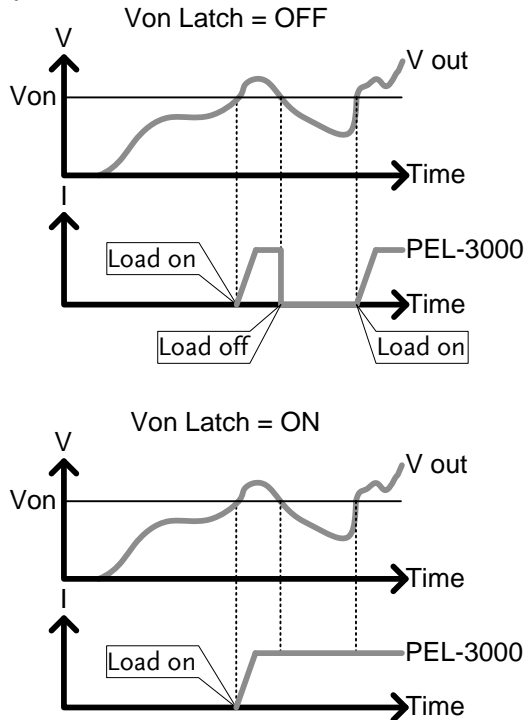

Operation

1. Press **Main** > *Configure*[F5] > *Other*[F2] and set the *Von Latch* setting.
 Range: Von Latch: OFF, ON

Von Voltage Delay

Description Von Delay is the amount of time the unit will wait before turning the load on after the Von Voltage threshold has been latched. This will prevent overshoot current from affecting the Von Voltage threshold.

Operation 2. Press  > *Configure*[F5] > *Other*[F2] and set the *Von Delay* time.
Range: Von Delay: OFF, 1.0~60ms

Note: CR mode can have the delay time set separately from the other modes (called *Von Delay -CR* when in CR mode).

Timer Functions

Count Time

Description When Count Time is set to on, it will count the elapsed time from when the load was turned on to when it was turned off.

- This function is applicable to manual and automatic shutdown (such as from protection functions such as UVP etc.)
- The elapsed time will be shown in the display Measurement area.

- Operation
1. Press **Main** > *Configure*[F5] > *Other*[F2] and turn the *Count Time* on or off.
Range: ON, OFF

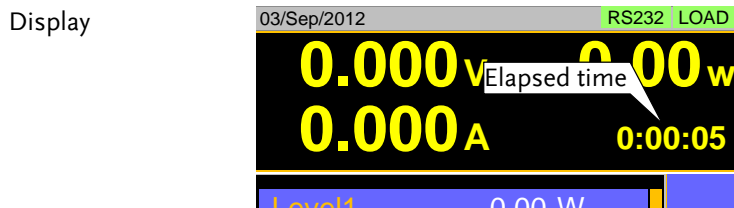

Cut Off Time

Description

The Cut Off Time function will turn the load off after a set-amount of time. After the load has been turned off, a popup screen will display the voltage level when the load was turned off.

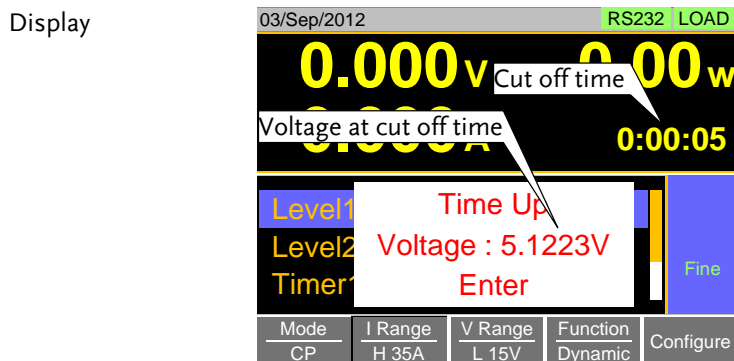

- Operation
1. Press **Main** > *Configure*[F5] > *Other*[F2] and set the *Cut Off Time*.
Range: OFF, 1 second ~ 999 hours:59 minutes:59 seconds



Auto Load Configuration

Description The PEL-3000 can be configured to automatically load the last program, normal sequence, fast sequence or load setting at startup.



By default, this setting is disabled.

- Operation**
1. Press  +  > *Load*[F2].
 2. Turn *Auto Load On* or *Off*.
 - When set to *OFF*, the *Auto Load* setting is disabled.
 3. Select the *Auto Load On* configuration.
 - This will select whether the PEL-3000 will automatically load the last program, normal sequence, fast sequence or load settings.

Auto Load On: *Load, Prog, NSeq, FSeq*

Load Off (Mode) and Load Off (Range)

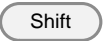

Description	<p>By default the load will automatically turn off when the either the operating mode (CC, CV, CR, CP) or the range (I range, V range) is changed.</p> <p>To allow the load to stay on when the operating mode is changed, set the <i>Load Off (Mode)</i> setting to <i>OFF</i>.</p> <p>To allow the load to stay on when the current or voltage range is changed, set the <i>Load Off (Range)</i> setting to <i>OFF</i>.</p> <hr/> <p>By default, these settings are set to <i>ON</i>.</p>
-------------	---

Operation	<p>1. Press  +  > <i>Load</i>[F2].</p> <p>2. Select <i>Load Off (Mode)</i> setting.</p> <ul style="list-style-type: none">• When set to <i>OFF</i>, the load will stay on when the operating mode is changed. <p>Load Off (Mode): OFF, ON</p> <p>3. Select <i>Load Off (Range)</i> setting.</p> <ul style="list-style-type: none">• When set to <i>OFF</i>, the load will stay on when the range is changed. <p>Load Off (Range): OFF, ON</p>
-----------	--

Safety Short

Description When activated, the safety short function only allows the short key to be used when the load is already on.

Operation

1. Press  +  > *Load*[F2].
2. Select the *Short (safety)* setting.
 - When set to OFF, the load can be shorted at anytime.
 - When set to ON, the load can only be shorted when the load is already on.

Short (Safety): OFF, ON

Step Resolution Configuration

There are two different ways to set the set resolution when using the scroll wheel to edit parameters. Step Mode and Cursor Mode. Step Mode is the default method. Only one mode can be active at a time; When one mode is active, the other mode is deactivated.

Cursor Mode Configuration

Description Cursor mode allows you to edit the selected parameter one digit at a time. When editing a parameter, pressing the scroll wheel determines which digit is selected. Turning the scroll wheel will then edit the parameter by the step resolution of the digit.

See the Conventions section on page 43 for operation details.

Operation 1. Press **Main** > *Configure*[F5] > *Next Menu*[F4] > *Knob*[F2] and set the *Status* setting is set to *Cursor*.

Display

The screenshot shows the 'Configure' menu on a device. At the top, it displays '03/Sep/2012' and 'RS232 LOAD'. The main menu is titled 'Configure' in green. Below it, there are two columns: 'Status' and 'Cursor'. The 'Status' column has a blue header and lists 'CCH Step', 'CCM Step', 'CCL Step', and 'CRH Step'. The 'Cursor' column lists the corresponding values: '1.000 A', '0.5000 A', '0.183575 A', and '0.4 mS'. To the right of the main menu is a vertical blue bar with 'CC', '35A', '15V', and 'Static' listed. At the bottom of the screen, there are five buttons: 'Parallel', 'Knob', 'External', 'Previous Menu', and 'A Value'.

Status	Cursor
CCH Step	1.000 A
CCM Step	0.5000 A
CCL Step	0.183575 A
CRH Step	0.4 mS

Step Mode Configuration

Description When set to Step Mode, the voltage, current, resistance and power settings can have the step resolution configured. The step resolution refers to the step resolution of the coarse adjustment for these settings. The fine adjustment cannot be configured.

See the Conventions section on page 43 for details on how to switch between coarse and fine adjustment modes.

Settings The step resolution of each setting is configured separately for each current range.

Settings	Description
CCH Step	CC mode, IRange = High
CCM Step	CC mode, IRange = Middle
CCL Step	CC mode, IRange = Low
CRH Step	CR mode, IRange = High
CRM Step	CR mode, IRange = Middle
CRL Step	CR mode, IRange = Low
CVH Step	CV mode, VRange = High
CVL Step	CV mode, VRange = Low
CPH Step	CP mode, IRange = High
CPM Step	CP mode, IRange = Middle
CPL Step	CP mode, IRange = Low

Operation

1. Press **Main** > *Configure*[F5] > *Next Menu*[F4] > *Knob*[F2] and make sure the *Status* setting is set to *Step*.
2. Set the desired step resolution settings. (The step resolution settings are only available when *Status=Step (coarse/fine)*)

 - For example if the step resolution for CCM Step is 0.5A, then the resolution can be incremented in 0.5A steps.

Display

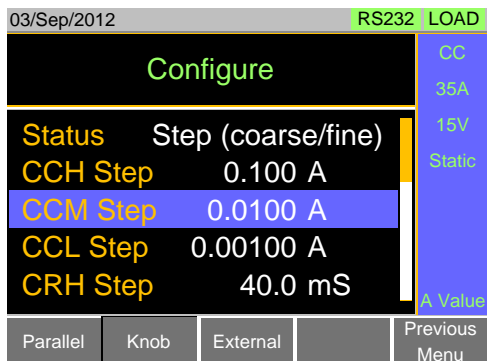

Protection Settings

The Protection settings are used to prevent damage to the unit or the DUT by excessive current, voltage or power.

An alarm is generated and a message is displayed on the screen when a protection setting is tripped. When an alarm is activated, the load is turned off (or limited), and the ALARM STATUS pin of the J1 connector on the rear panel (pin 16) turns on (open collector output by a photocoupler). The protection settings can be used regardless of whether the remote sense connections are used or not.

OCP

Description	<p>For OCP, the PEL-3000 can be configured to either limit the current or turn off the load.</p> <p>The OCP levels can be set to 10% higher than the rating current.</p>
Operation	<p>1. Press Main > <i>Configure</i>[F5] > <i>Protection</i>[F1] and set the <i>OCP Level</i> and <i>OCP Setting</i>.</p> <p>Range: <i>OCP Level</i>: Rating current + 10% <i>OCP Setting</i>: LIMIT, Load Off</p>
Alarm	<ul style="list-style-type: none">• When <i>OCP Setting</i> is configured to <i>Load Off</i>, a message will be displayed on the screen when OCP is tripped. The Enter key must be pressed to clear the alarm message.• When configured to <i>LIMIT</i>, OCP will be displayed on the screen when the OCP is tripped and the current will be limited to the <i>OCP Level</i> setting.

Display

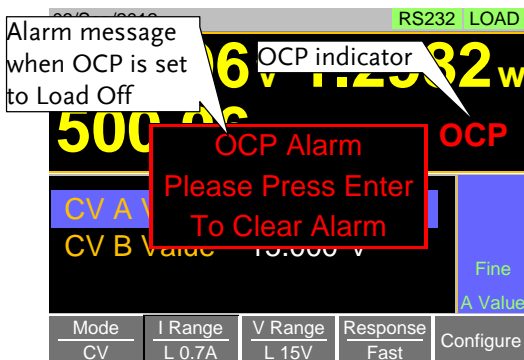

OPP

Description

For OPP, the PEL-3000 can be configured to either limit the power or turn off the load.

The OPP levels can be set to 10% higher than the rating power.

Operation

1. Press **Main** > *Configure*[F5] > *Protection*[F1] and set the *OPP Level* and *OPP Setting*.
 Range: *OPP Level*: Rating power + 10%
 OPP Setting: LIMIT, Load Off

Alarm

- When *OPP Setting* is configured to *Load Off*, a message will be displayed on the screen when OPP is tripped. The Enter key must be pressed to clear the alarm message.
- When configured to *LIMIT*, OPP will be displayed on the screen when the OPP is tripped and the power will be limited to the *OPP Level* setting.

Display

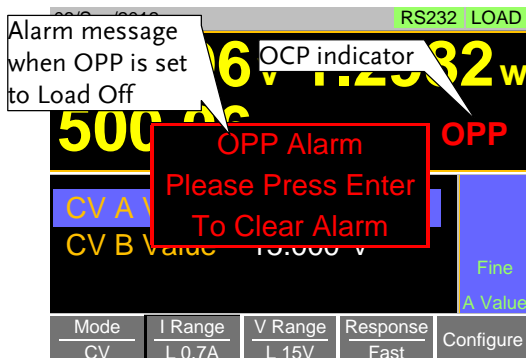

UVP

Description If the UVP is tripped, the PEL-3000 will turn off the load.

The UVP levels can be set from 0V to 10% higher than the rating voltage.

Operation 1. Press **Main** > *Configure*[F5] > *Protection*[F1] and set the *UVP Level*.
 Range: UVP Level: OFF, 0~Rating voltage + 10%

Alarm

- The UVP indicator and a message will only appear on the screen when the input voltage is below the UVP level. The Enter key must be pressed to clear the alarm message.
- To clear the UVP indicator, remove the cause of the under voltage ~ i.e., increase the input voltage.

Display

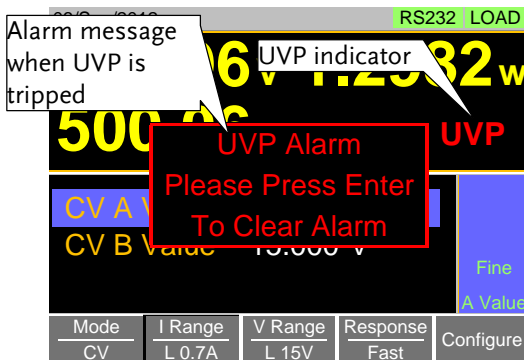

OVP

Description If the OVP is tripped, the PEL-3000 will turn off the load.

The OVP levels can be set from 0V to 10% higher than the rating voltage.

Operation 1. Press **Main** > *Configure*[F5] > *Protection*[F1] and set the *OVP Level*.

Range: OVP Level: OFF, 0~Rating voltage + 10%

Note: To turn OVP off, set the OVP voltage greater than the current rating voltage + 10%.

Alarm • The OVP indicator and a message will only appear on the screen when the input voltage is below the UVP level. The Enter key must be pressed to clear the alarm message.

• To clear the OVP indicator, remove the cause of the over voltage ~ i.e., reduce the input voltage.

Display

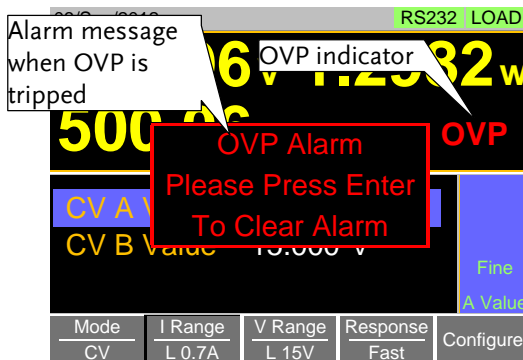

UnReg

Description

The UnReg error message will appear on the display when the electronic load is operating in an unregulated state.

Alarm

- The UnReg indicator will appear on the display when the set load is inadequate for the source.
- To clear the UnReg indicator, increase the load or reduce the load requirements.

Display

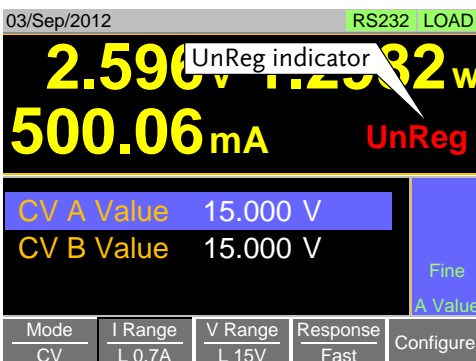

Para

Description The Para error message will appear on the display when the PEL-3000 is used in parallel and if an error is produced.

- Alarm**
- The Para error message indicates one of the following possible conditions: UnReg, ROCP, OTP.
 - To clear the Para indicator, remove the cause of the alarm.

Display

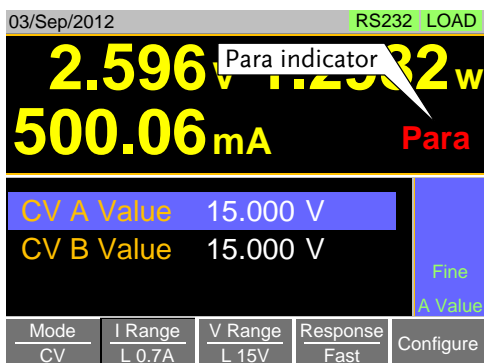

System Settings

The following section covers a number of miscellaneous system settings such as:



- Speaker settings
- Display settings
- Alarm tone settings
- Input control settings
- Language settings

All system settings are accessible in the Utility menu.

Sound Settings

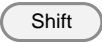

Speaker Settings

Description	Turns the speaker sound on or off for the user interface, such as key press tones and scrolling tones.
-------------	--

- | | |
|-----------|--|
| Operation | <ol style="list-style-type: none">1. Press  +  > <i>Other</i>[F5].2. Set the <i>Speaker</i> settings on or off.<ul style="list-style-type: none">• When set to OFF, the speaker setting will not disable the tones for Go-NoGo or protection alarms. |
|-----------|--|

Alarm Tone Settings

Description The alarm tone for the unit can be turned on or off in the utility menu. The alarm tone can be set separately for the protection settings (OCP, OPP, UVP, OVP), Go-NoGo testing or for when the unit is operating in an unregulated state (see page 87).



- Operation**
1. Press  +  > *Other*[F5].
 2. Set the alarm tone settings on or off.
 - The alarm tone settings ignore the *Speaker* setting.

Alarm Tone: ON, OFF
 UnReg Tone: ON, OFF
 Go_NoGo Tone: ON, OFF

Display Settings

Contrast and Brightness

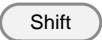
Description Sets the contrast level.

- Operation**
1. Press  +  > *Other*[F5].
 2. Set the *Contrast* and *Brightness* settings.



Range: Contrast: 3 ~ 13 (low ~ high)
 Brightness: 50 ~ 90 (low ~ high)

Control Settings

Description The Knob Type setting determines if values are updated immediately as they are edited or if they are only updated after the Enter key is pressed.

The *Updated* setting is applicable for when the load is already on and the user wishes to change the set values (current, voltage, etc.) in realtime.

The *Old* setting will only update the values after the Enter key is pressed.

- Operation**
1. Press  +  > *Other*[F5].
 2. Set the *Knob type* and *Slave knob* settings.
Range: Knob type: Updated, Old

Language Settings

Description The PEL-3000 supports only English.

- Operation**
1. Press  +  > *Other*[F5].
 2. Set the *Language* setting.
Supported languages: English

Go-NoGo

The Go-NoGo configuration is used to create pass/fail limits on the voltage or current input. If the voltage/current exceeds the pass/fail limits, an alarm will be output.

The Go-NoGo configuration can be used with the Program function to create complex pass/fail tests.

Setting the Go-NoGo Limits

Description	The Go-NoGo setting limits can be set as either discrete high & low values or as a percentage offset from a center value.
-------------	---

Operation	<ol style="list-style-type: none"> 1. Press  > <i>Configure</i>[F5] > <i>Go-NoGo</i>[F3]. 2. Select <i>Entry Mode</i> and choose how to set the pass/fail limits. <ul style="list-style-type: none"> • Value will allow you to set the limits as discrete values. • Percent will allow you to set the limits as a percentage offset from a center value. 3. If <i>Entry Mode</i> was set to <i>Value</i>, Set the <i>High & Low</i> limit values. <ul style="list-style-type: none"> High: 0~rating current/voltage Low: 0 ~rating current/voltage 4. If <i>Entry Mode</i> was set to <i>Percent</i>, Set the <i>Center</i> voltage/current and <i>High, Low</i> % values. <ul style="list-style-type: none"> Center: 0~rating current/voltage High: 0~100% of center voltage/current Low: 0~100% of center voltage/current
-----------	--

5. Set the *Delay Time*.
 - The delay time setting will delay activating the Go-NoGo testing by a specified amount of time.
 - The delay setting can compensate for startup oscillation and other instabilities during startup.
Delay Time 0.0~1.0 seconds (0.1s resolution)



Note

When the Main settings are saved or recalled, the Go-NoGo settings are also saved/recalled. See the Save/Recall chapter for details, page 122.

Running a Go-NoGo Test

Description	<p>Go-NoGo test results are displayed in the measurement panel.</p> <ul style="list-style-type: none"> • GO indicates pass (good). • NG indicates fail (no good).
Operation	<ol style="list-style-type: none"> 1. Press  > <i>Configure</i>[F5] > <i>Go-NoGo</i>[F3]. 2. Set <i>SPEC Test</i> to ON. <ul style="list-style-type: none"> • When SPEC Test is ON, SPEC will appear in the Operation Status Panel. This means the unit is ready for Go-NoGo testing. 3. Turn the load on. <ul style="list-style-type: none"> • The test starts from the time the load was turned on + the Delay Time.

Display:
GO

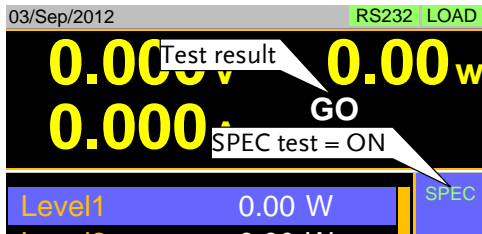

Display:
NG

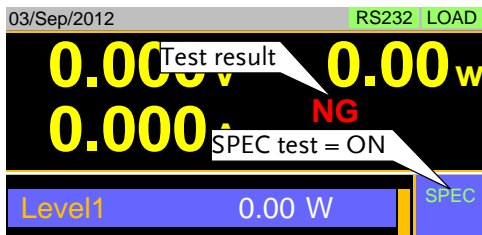

Program

The PEL-3000 can create programs that are designed to step-through up to 16 pre-set load operations. The program function is a powerful tool that can allow you to perform a number of different operations in succession.

- The execution time of each step is user-defined.
- Programs can be chained together to make larger programs.
- Up to 16 programs can be created for a program chain.

See page 122 for saving load operations.

Program Overview

Description	<p>When you run a program, you are essentially executing up to 16 different load operations consecutively. Each of the different load operations are “steps” in the program. A program starts at step 01 and ends at step 16.</p> <ul style="list-style-type: none">• A program recalls the operating mode, range, static/dynamic mode, response speed and other settings of each step from stored memory. It also recalls the Go-NoGo settings.• The same memory settings can be used for multiple steps.• The execution time of each step is configurable.• Applies the Go-NoGo settings for each step.• Each step must be executed in order.• Each step can be configured to automatically go to the next step or wait for confirmation from the user before proceeding to the next step.• Individual steps can be skipped.• Programs can be linked together to make
-------------	--

program chains.

- Program chains need not be executed in order.
- There are 16 steps to a program.
- There are up to 16 programs to a chain.

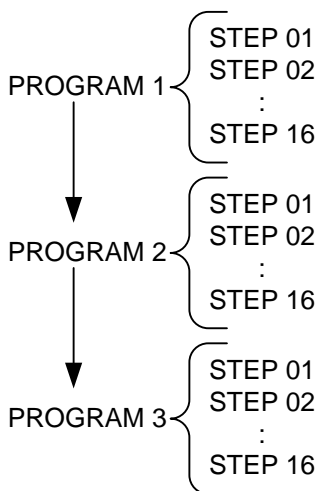

Setting Overview

A program contains the following settings for each step:

- Memory: the memory location of the load operation for the selected step (M001~M256).
- Run: Designates the run setting for the step (Auto, Manual, Skip).
- On-Time: Sets the run time of the test.
- Off-Time: Sets the off time between steps.
- P/F-Time: Sets the testing pass/fail delay time for GoNo Go testing.
- Short-Time: Sets the shorting time for the step, if any.

Timing Diagram
for Single Step

Below is a timing diagram of a single step in a program.

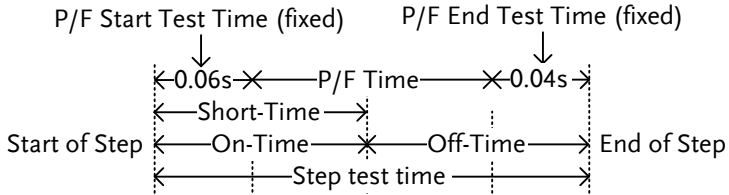

Create a Program



Note

Before creating a program, the settings for each step must first be created and saved to internal memory (M001~M256). See the save recall chapter for further details, page 122.

Program Setting
Display Overview

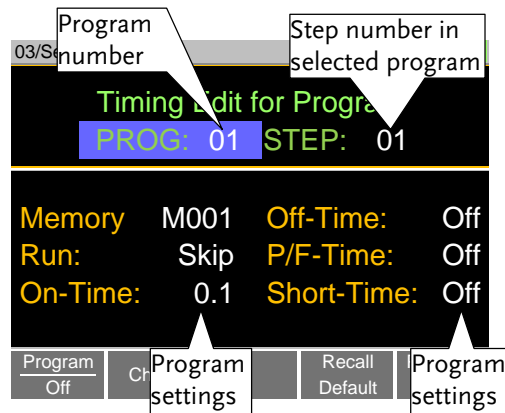

Operation

1. Press **FUNC** > *Program*[F1].
 - Note that *Program*[F1] is off by default.
2. Select *PROG* and select a program number to edit.

PROG 01 ~ 16

3. Select a *STEP* in the selected program.

STEP 01 ~ 16

4. Select *Memory* and select which memory location to load for the selected step.

- Settings loaded from the memory location will be used for the selected step.
- The same memory location can be used for multiple steps.

Memory M001 ~ M256

5. Set the *Run* setting for the step.

- By default RUN is set to Skip.
- The Auto setting will automatically start and go onto the next step.
- The Manual setting will wait for the user to press *Next[F2]* before running the step.

Run Skip, Auto, Manual

6. Choose the *On-Time* in seconds.

- The on-time setting determines how long the load is turned on for the selected step.
- The on-time is defined as the total test time minus the off-time.

On-Time 0.1 ~ 60 seconds

7. Choose the *Off-Time* in seconds.

- The off-time setting determines how long the load is turned off between the end of the current step and the start of the next step.
- The off-time is defined as the total test time minus the on-time.

Off-Time Off, 0.1 ~ 60 seconds

8. Choose the *P/F-Time* (pass/fail time) in seconds.
 - The P/F-Time refers to the P/F delay time. This delay time includes the 0.06 P/F start test time, as shown in the timing diagram on page 97.
P/F-Time Off, 0.0 ~ 119.9 seconds
 9. Set the *Short-Time* in seconds.
 - Has the same action as pressing the short key. See page 63 for details about shorting the load.
Short-Time Off, 0.1 seconds ~ On-Time
 10. Repeat steps 3 to 9 for all the steps in the program.
 - A maximum of 16 steps per program can be created.
 - Steps that are not configured are set to “Skip” by default.
 11. Press *Save[F3]* to save the program and all the steps in the program.
 - The program will be saved to internal memory.
 - See the Save/Recall chapter on details on how to save to Setup memory.
-

Recall Default

Pressing *Recall Default[F4]* will recall the default settings for each program/step. See page 181 for details.

Create a Program Chain



Note

Before creating a program chain, make sure a number of programs have already been saved. These will be used to create the program chain.

Chain Setting
Display Overview

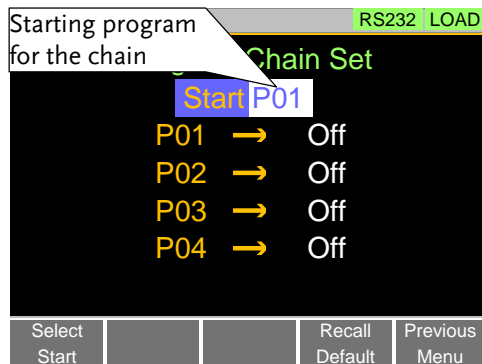

Operation

1. Press **FUNC** > *Program*[F1] > *Chain*[F1].
 - It may be necessary to load the programs from Setup memory if they were not created in the current session.
2. If *Start* is not already selected, press *Select Start*[F1] and select which program will be used to start the program chain.
 Start: P01 ~ P16
3. Select *P01* and choose which program will be linked to P01.
 - Selecting OFF will end the chain after P01.
 - Selecting P01 will create an infinite chain.
 - Chains need not be linked in sequential order.
 P01: OFF, P01 ~ P16

4. Repeat step 3 for any remaining programs in the chain.
5. Press *Save* to save the program chain to internal memory.

Pressing *Recall Default*[F4] will reset the chain to the default settings. See page 181 for details.

- Recall Default[F4] will essentially clear the program chain.

Running a Program or Chain

Description	A program or program chain is run the same way as a normal load.
-------------	--

- | | |
|-----------|---|
| Operation | <ol style="list-style-type: none"> 1. Press  > <i>Program</i>[F1]. 2. Turn program mode on by setting <i>Program</i>[F1] to On. <ul style="list-style-type: none"> • PROG will appear at the top of the display when <i>Program</i> is On. 3. Turn the load on. <ul style="list-style-type: none"> • The program/chain starts immediately. • The PROG icon turns orange when the load is turned on. 4. When a program/chain is running the screen displays which program, step and memory is currently active. <ul style="list-style-type: none"> • Press <i>Pause</i>[F1] to suspend a test, press <i>Continue</i>[F1] to resume. • Press <i>Next</i>[F2] to run the next step if its <i>Run</i> setting was set to <i>Manual</i>. |
|-----------|---|

5. When a program/chain has finished running, a list of the Go-NoGo results for each step are displayed.
 - Press *Exit*[F5] to exit.

Display:
Program/Chain
Running

The screenshot shows the 'Run Program' screen with the following text: '03/Sep/2012' at the top left, 'RS232 PROG' at the top right, '0.000v' and '0.00w' in large yellow digits, and '0.000A' in large yellow digits. Below this, it says 'Run Program', 'Program No: 01', and 'Step(Memory) 01(001) GO'. Callout boxes point to '01' (Program number that is currently running.), '01(001)' (Step that is currently running.), and 'GO' (No-NoGo result for the step). A bottom callout points to '(001)' (Memory number of current step.).

Display:
Program/Chain
Finished

The screenshot shows the 'Run Program Detail Result' screen with the following text: '03/Sep/2012' at the top left, 'RS232 PROG' at the top right, and 'Run Program Detail Result' in green. Below this is a table with three columns: Program, Step, and Result.

Program	Step	Result
1	1	GO
1	2	GO
1	3	NG

At the bottom right of the screen, there is an 'Exit' button.

Sequence

The PEL-3000 supports both programs and sequences. The essential difference between programs and sequences is that programs can use different operating modes for each step while sequences use the same operating mode throughout the whole sequence. In effect sequences are used to create complex load simulations.

There are two different types of Sequences, Normal Sequences and Fast Sequences.

Normal sequences can define the execution time and slew rate of each step.

On the other hand the execution time for each step in a fast sequence is fixed to the rate (Time Base setting) set by the user.

Normal Sequence Overview

Description	<p>A normal sequence is comprised of a user-defined number of steps that when executed in sequence can be used to simulate a DC load.</p> <ul style="list-style-type: none">• Up to 1000 discrete steps can be configured using normal sequences.• Each normal sequence can have a memo note attached to it.• Normal Sequences can be looped up to 9999 discrete times or for an infinite amount of times.• Normal sequences can be configured to hold a set voltage, current, power or resistance at the end of the load.• Normal Sequences can be linked together in a chain.
-------------	---

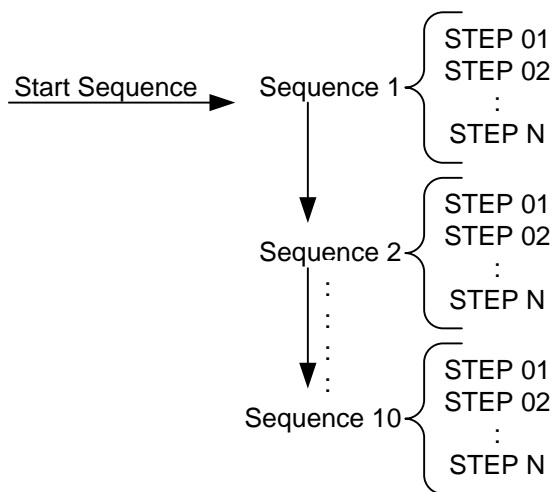

Description

Normal Sequence configuration is split into Timing Edit configuration and Data Edit configuration.

Timing Edit configuration is used to configure the actual sequences, such as mode, range, loops and chains.

Data Edit configuration is used to create the actual steps used in each sequence.

See below for a description of each.

Timing Edit Overview

A Normal Sequence contains the following timing settings for each sequence:

Setting	Setting Range	Description
Start	S01 ~ S10	Sets which sequence is used to start a chain of Normal Sequences.
Seq.No	S01 ~ S10	Sets the current sequence to edit.

Memo	12 characters	A user-created note for the currently selected sequence.
Mode	CC, CR, CV, CP	Operating mode for the sequence. +CV mode is supported.
Range	ILVL	Low I range, low V range
	IMVL	Middle I range, low V range
	IHVL	High I range, low V range
	ILVH	Low I range, high V range
	IMVH	Middle I range, high V range
	IHVH	High I range, high V range
Loop	Infinite, 01 ~ 9999	Sets the amount of times to loop the selected sequence.
Last Load	OFF, ON	Set the load condition after the end of the sequence.
Last	Value	The setting value of the load for when Last Load = ON.
Chain	Off, S01~S10	Sets the next sequence in the chain, when not set to off.

Data Edit Overview Each step in a normal sequence contains the following setting parameters:

Setting	Setting Range	Description
Step	0001 ~ 1000	Selects/displays the current step in the sequence. <ul style="list-style-type: none"> The number of available steps is dependent on the number of steps added using the <i>Insert Point[F1]</i> functions.
Value		The current, voltage, power or resistance setting for the selected operating mode.
Load	ON, OFF	Turns the load on or off for the selected step.

RAMP	ON, OFF	When turned on the current transition is evenly ramped from the start of the step to the end of the step. When turned off the current transition is stepped.
------	---------	--

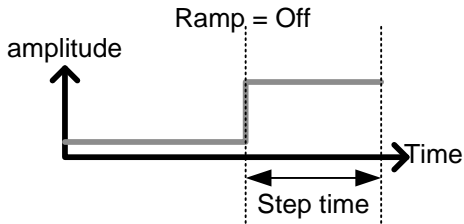
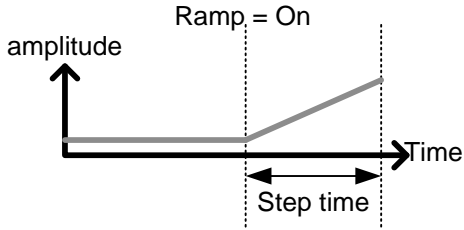

TRIG OUT	ON, OFF	When TRIG OUT is set to ON, a trigger signal is output from the TRIG OUT BNC terminal at the start of the step. See page 153 for details.
----------	---------	---

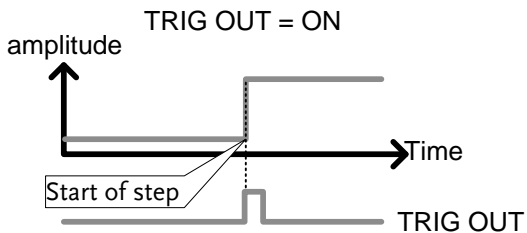

PAUSE	ON, OFF	Pause: Inserts a pause at the end of the step. When paused, the unit will pause at the end of the step current/voltage/resistance/power level. The sequence can be resumed by pressing <i>Next</i> [F2] or by using an external trigger signal (page 150).
-------	---------	--

Timing Edit Configuration

Edit Timing
Display

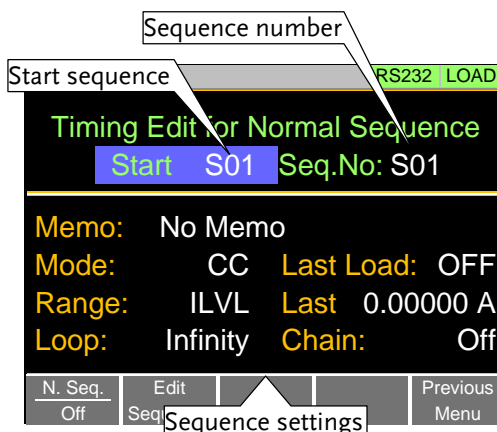

Operation

- Press **FUNC** > *Sequence*[F2] > *Normal Sequence*[F1].
 - Note that *N. Seq.*[F1] is off by default.
- Select *Start* and select the number of the starting sequence.
Start: S01 ~ S10
- Select a *Seq. No.* and select which sequence to edit.
Seq. No.: S01 ~ S10

4. Set the following parameters for the currently selected sequence. See page 103 for details on each parameter.
 - Memo
 - Mode
 - Range
 - Loop
 - Last Load
 - Last
 - Chain
5. Press *Save*[F3] to save the timing settings for the currently selected sequence.

Sequence Timing configuration is complete.

- Go to Data Edit to edit the steps used in the Normal Sequences. See page 109.
- Go to Running a Normal Sequence to run the normal sequence. See page 111.

Data Edit Configuration

Data Edit Display

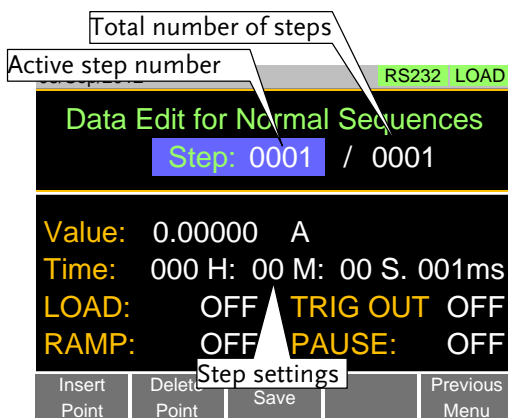

Operation

1. Press **FUNC** > *Sequence*[F2] > *Normal Sequence*[F1].
2. Select *Seq.No.* and select the sequence you wish to edit.
Start: S01 ~ S10
3. Press *Edit Sequence* [F2] to enter the Data Edit configuration menu.
 - Note that when there no steps in the current sequence the Data Edit for Normal Sequence settings are blank.
4. Press *Insert Point*[F1] to add a step to the sequence after the current step.
 - Every time *Insert Point* is pressed the *Step* parameter is incremented.
 - The inserted point becomes the current step.

5. Set the following parameters for the currently selected step. See the Data Edit Overview on page 105 for configuration details.
 - Value
 - Time
 - LOAD
 - RAMP
 - TRIG OUT
 - PAUSE
6. If you wish to edit a previously inserted point/step, use the *Step* parameter.
 - Steps can only be selected after they have already been inserted.
Steps 0001 ~ 1000
7. The currently selected step can be deleted using the *Delete Point[F2]* function.
8. After all the steps for the sequence are complete, press *Save[F3]* to save the steps.

Data Edit for Normal Sequence configuration is complete.

- Go to Timing Edit for Normal Sequences to edit the sequence. Page 107.
- Go to Running a Normal Sequence to run the normal sequence. Page 111.

Running a Normal Sequence

Description	A load created with the Normal Sequence function is run the same way as a normal load.
Operation	<ol style="list-style-type: none">1. Press  > <i>Sequence[F1]</i> > <i>Normal Sequence [F1]</i>.2. Turn normal sequence mode on by setting <i>N. Seq.[F1]</i> to <i>On</i>.<ul style="list-style-type: none">• NSEQ will appear at the top of the display when <i>N. Seq.</i> is <i>On</i>.3. Turn the load on.<ul style="list-style-type: none">• The normal sequence/chain starts immediately.• The NSEQ icon turns orange when the load is turned on.4. When a normal sequence/chain is running, the screen displays which sequence, step and loop are currently active.<ul style="list-style-type: none">• Sequences can be paused by pressing <i>Pause[F1]</i> and resumed again by pressing <i>Continue[F1]</i>.• If no steps have been created “No N.Seq.” will be displayed on the screen.• “<i>Sequence Complete</i>” will be displayed at the end of the sequence.

Display:
Sequence/Chain
Running

03/Sep/2012		RS232		NSEQ
0.000 V		0.00 W		
0.000 A				
Run N.Seq.	Seq. No:	01		
	Step	0003		
	Loop:	0001		
Continue				

Fast Sequence Overview

Description

A fast sequence is comprised of a user-defined number of steps that can be executed at a high frequency. Unlike normal sequences, each step in a fast sequence has the same execution time (time base).

- This mode is only available for CC and CR mode.
- Up to 1000 discrete steps can be configured using fast sequences.
- Each fast sequence can have a memo note attached to it.
- Fast Sequences can be looped up to 9999 discrete times or for an infinite amount of times.
- Fast sequences can be configured to hold a set current or resistance at the end of the load.
- No ramping function can be used with the Fast Sequence function.

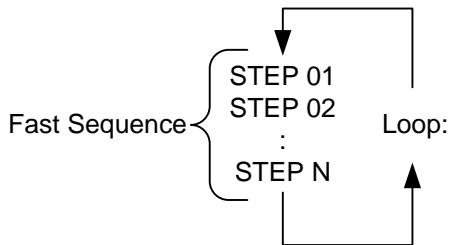

Description Fast Sequence configuration is split into Timing Edit configuration and Data Edit configuration.

Timing Edit configuration is used to configure all the settings that are common to all the steps of the fast sequence. This includes settings such as the mode, range, loops and time base.

Data Edit configuration is used to create the actual steps used in each sequence.

See below for a description of each.

Timing Edit Overview A Fast Sequence contains the following timing settings for each sequence:

Setting	Setting Range	Description
Memo	12 characters	A user-created note for the currently selected sequence.
Mode	CC, CR	Operating mode for the sequence.
Range	ILVL	Low I range, low V range
	IMVL	Middle I range, low V range
	IHVL	High I range, low V range
	ILVH	Low I range, high V range
	IMVH	Middle I range, high V range
Loop	IHVH	High I range, high V range
	Infinity, 01 ~ 9999	Sets the amount of times to loop the selected sequence.
Last Load	OFF, ON	Set the load condition after the end of the sequence.
Last	0.000000	The load setting for when Last Load is set to ON.
RPTSTEP	0001 ~ 1000	Last step number (0001~1000) per loop

Data Edit Overview Each step in a fast sequence contains the following setting parameters:

Setting	Setting Range	Description
Step	0001 ~ 1000	<p>Selects/displays the current step in the sequence.</p> <ul style="list-style-type: none"> The number of available steps is dependent on the number of steps added using the <i>Ins. Point[F1]</i> functions. A minimum of 3 steps.
Value		The current or resistance setting for the selected operating mode.
TRIG OUT	ON, OFF	<p>When TRIG OUT is set to ON, a trigger signal is output from the TRIG OUT BNC terminal at the start of the step. See page 153 for details.</p>

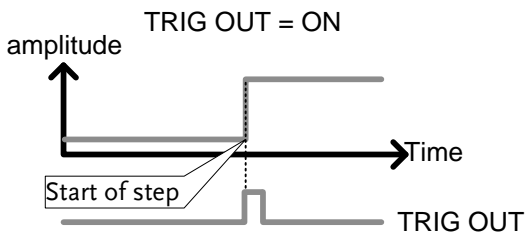

FILL Overview The FILL function is used to evenly step up the current or resistance value settings from a starting step to a finishing step.

The Fill Function can be used before or after points are added to the fast sequence.

- Before: Will pre-fill each value within the fill range when a new step is added.
- After: Will post-fill each value within the fill

range.

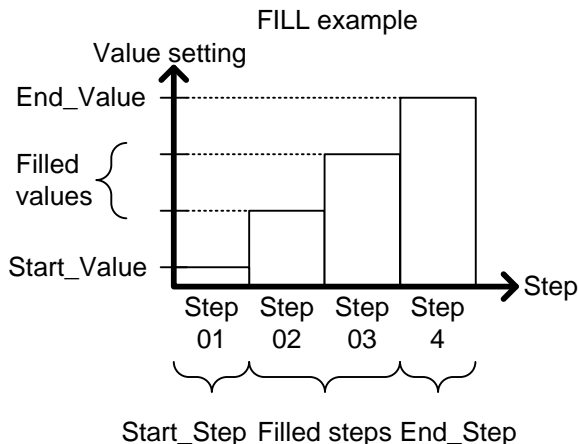

Setting	Setting Range	Description
Start_Value		Sets the current or resistance value for the starting step.
End_Value		Sets the current or resistance value for the ending step.
Start_Step	0001 ~ 1000	Sets the starting step number.
End_Step	0001 ~ 1000	Sets the ending step number.

Timing Edit Configuration

Edit Timing
Display

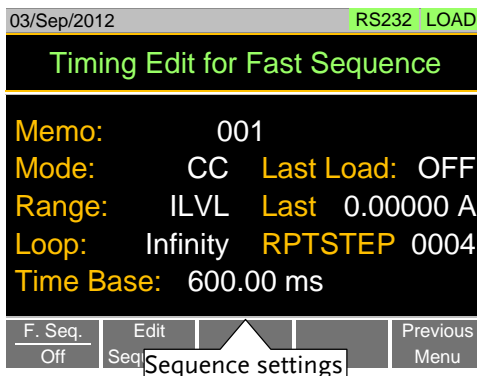

Operation

1. Press **FUNC** > *Sequence[F2]* > *Fast Sequence[F2]*.
 - Note that *F. Seq.[F1]* is off by default.
2. Set the following parameters for the fast sequence. See page 115 for details on each parameter.
 - Memo
 - Mode
 - Range
 - Loop
 - Time Base
 - Last Load
 - Last
 - RPTSTEP

Save

Press *Save[F3]* to save the timing settings for the fast sequence.

Sequence Timing configuration is complete.

- Go to Data Edit to edit the steps used in the Fast Sequence. Page 118.
- Go to Running a Fast Sequence to run the fast sequence. Page 120.

Data Edit Configuration

Data Edit Display

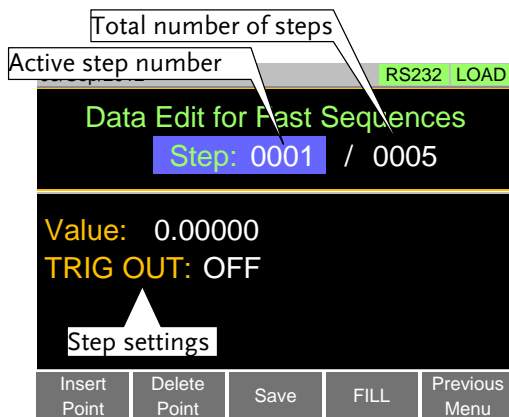

FILL Display

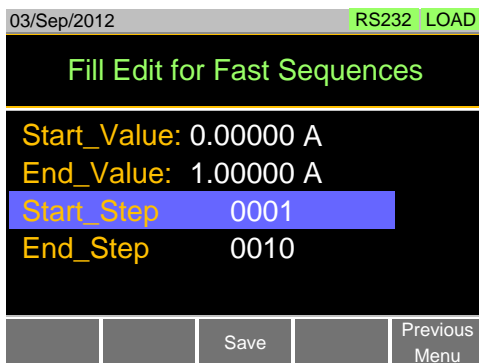

Operation

1. Press **FUNC** > *Sequence*[F2] > *Fast Sequence*[F2] > *Edit Sequence*[F2] to enter the Data Edit configuration menu.

2. Press *Insert Point*[F1] to add a step to the sequence.
 - Every-time *Insert Point* is pressed the *Step* parameter is incremented.
 - The newly inserted “point” becomes the active step.
 3. Set the following parameters for the currently selected step. See page 118 for configuration details.
 - Value
 - TRIG OUT
 4. If you wish to edit a previously added point/step, use the *Steps* parameter.
 - Steps can only be selected after they have already been added.
Steps 0001 ~ 1000(RPTSTEP)
 5. The currently selected step can be deleted using the *Delete Point*[F2] function.
 - There cannot be less than 3 steps for fast sequences.
-

Fill Function Press *FILL*[F4] to use the fill function. Set the fill parameters:

- Start_Value
- End_Value
- Start_Step
- End_Step

The fill function can be used any number of times.

Save After all the steps for the sequence are complete, press *Save*[F3] to save the steps.

Data Edit for Fast Sequences configuration is complete.

- Go to Timing Edit for Fast Sequences to edit the sequence. Page 117.
- Go to Running a Fast Sequence to run the fast sequence. Page 120.

Running a Fast Sequence

Description A Fast Sequence is run the same way as a normal load.

- Operation
1. Press **FUNC** > *Sequence*[F2] > *Fast Sequence*[F2].
 2. Turn fast sequence mode on by setting *F. Seq.*[F1] to *On*.
 - **FSEQ** will appear at the top of the display when *F. Seq.* is *On*.
 3. Turn the load on.
 - The fast sequence/chain starts immediately.
 - The **FSEQ** icon turns orange when the load is turned on.
 4. When a fast sequence is running, the screen displays which step and loop is currently active.
 - “*Sequence Complete*” will be shown on the display at the end of the sequence.

Display:
Fast Sequence
Running

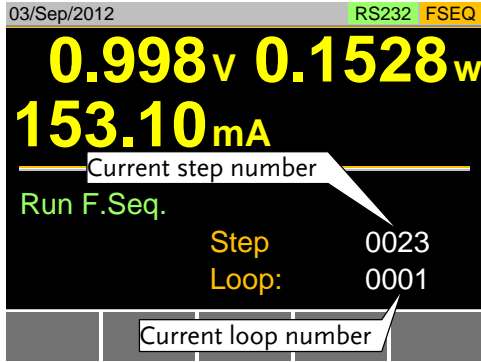

Save Recall

The PEL-3000 can save and recall system settings, preset data, memory data, Go-NoGo settings as well as normal and fast sequences to internal memory or to USB.

File Structure

Description The PEL-3000 file system can save files to internal memory (Media | Memory) and external memory (Media | USB).

To save or recall Memory, Setup or Preset data, the PEL-3000 uses a three tier system where files are saved or recalled in the following order:

Active settings <> Internal memory <> USB.

This can be best described in the picture below.

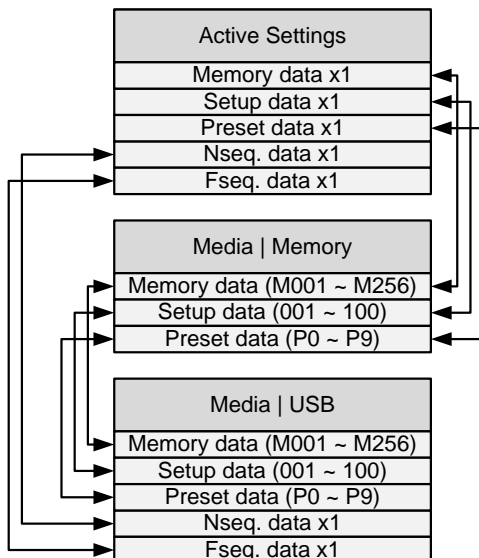

For example:

To load Preset Data P7 from USB, you must first load Preset Data P0~P9 to internal memory, then from internal memory load Preset P7 to be the active preset setting.

For normal and fast sequences however, files can be saved or recalled directly to/from USB memory.

File Types

Memory Data Memory data contains general settings and is used for creating programs. Memory Data contains the operating mode, range, response and Go/NoGo settings. Memory data can be stored both internally and externally to USB. Preset data and Memory data store the same contents.

Internal Format M001 ~ M256

External Format model no_file no.M
example: 3021_01.M

Setup Data Setup data contains all general configuration settings, protection settings, program and program chain settings, as well as parallel configuration settings.

Internal Format 1 ~ 100

External Format model no_file no.S
example: 3021_00.S

Preset Data Preset Data contains the same settings as the Memory Data. Preset Data contains the operating mode, range, response and Go-NoGo settings.

Internal Format P0 ~ P9

External Format model no_file no.P
example: 3021_00.P

NSeq Data NSeq Data contains the Normal Sequence settings.

Internal Format None

External Format model no_file no.N
example: 3021_00.N

FSeq Data FSeq Data contains the Fast Sequence settings.

Internal Format None

External Format model no_file no.F
example: 3021_00.F

Saving Files to Internal Memory

Description When saving Memory, Setup or Preset Data to internal memory, the currently active setting is saved to one of the internal memory slots.

Memory Data has 256 memory slots, Setup Data has 100 memory slots and Preset Data has 10 memory slots.

Memory Data
Example

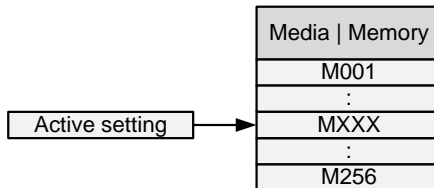

Display

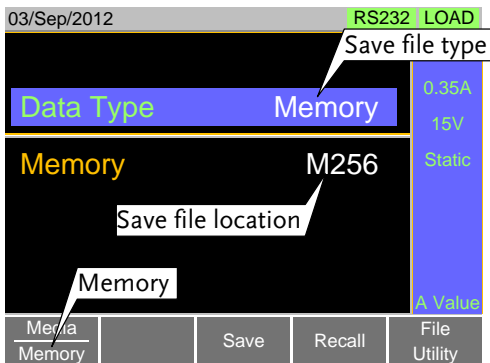

Operation

1. Press **Shift** + **File FUNC**.
2. Select Memory with the *Media[F1]* soft-key.
3. Select the *Data Type* and choose the type of file to save.
Data Type: Memory Data, Setup Data, Preset Data
4. Select which internal memory location to save the file.
Memory: M001 ~ M256
Setup Memory: 1 ~ 100
Preset: P0 ~ P9
5. Press *Save[F3]* to save.
 - Save Ok will be displayed when the save has been completed.



Note

Normal Sequence and Fast Sequence data cannot be recalled from or saved to an internal memory slot.

Saving Files to USB Memory

Description

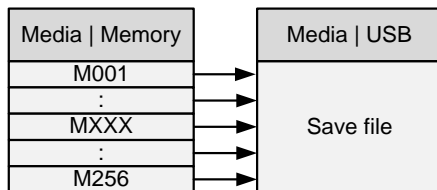

When saving files to USB memory, all the memory locations from the selected data type are saved as a single file to the USB file path directory.

Memory Data Example

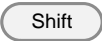

For example, Memory Data M001 to M256 are saved to a single file on USB.

Display

-
- Operation
1. Insert a USB drive into the USB port.
 2. Press  +  .
 3. Select USB with the *Media[F1]* soft-key.
 4. Select the *Data Type* and choose the type of file to save.
Data Type: Memory Data, Setup Data,
Preset Data, NSeq, FSeq
 5. Select *Save File* and choose a save filename.
 - Turn the scroll wheel to increase/decrease the file number.
Memory: Model_file number.M
Setup Memory: Model_file number.S
Preset: Model_file number.P
NSeq: Model_file number.N
FSeq: Model_file number.F
 6. Press *Save[F3]* to save.
 - The file will be saved to the USB file path.
 - Save Ok will be displayed when the save has been completed.
 - If saving-over an existing file you will be asked to confirm the save. Press *Save[F3]* to confirm.
-
- File Utilities
- Press *File Utility[F5]* to access the file utility. See page 132 for details.
- Change the USB path.
 - Rename files or create directories.

Recalling Files from Internal Memory

Description When recalling Memory, Setup or Preset Data from the internal memory slots, the recalled file becomes the active setting.

Memory Data has 256 memory slots, Setup Data has 100 memory slots and Preset Data has 10 memory slots.

Memory Data Example

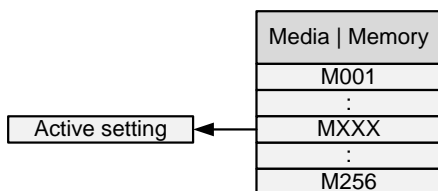

Display

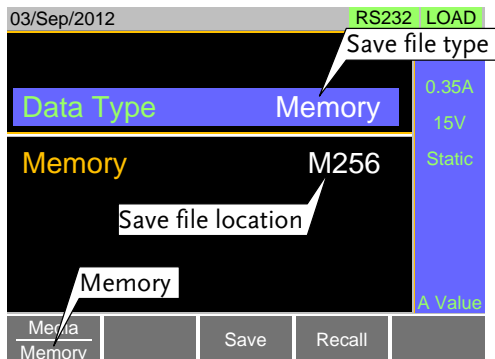

Operation

1. Press **Shift** + **FUNC** .
2. Select *Memory* with the *Media[F1]* soft-key.
3. Select the *Data Type* and choose the type of file to recall.
Data Type: Memory Data, Setup Data, Preset Data

4. Select which memory slot to recall from.
Memory: M001 ~ M256
Setup Memory: 1 ~ 100
Preset: P0 ~ P9
5. Press *Recall*[F4] to recall.
 - For Memory Data and Preset Data, a popup window will appear. Press the  key to confirm the recall.



Note

Normal Sequence and Fast Sequence data cannot be recalled from or saved to an internal memory slot. They can, however, be recalled directly from USB memory. See the next section below for details.

Recalling Files from USB Memory

Description

When recalling Memory, Setup or Preset files from USB memory, a single file from the USB drive will overwrite all the existing memory slots for the selected data type.

For Normal or Fast Sequence files, the recalled file becomes the active setting as these types of files don't have an internal memory slot.



Caution

You can only recall files from the same model.

Memory Data Example

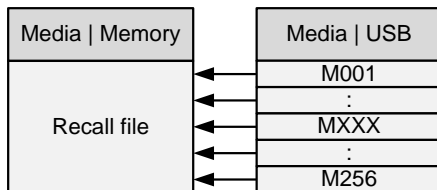

For example, if the file 3021_01.M is recalled, all the Memory Data from M001 to M256 will be overwritten.

Display

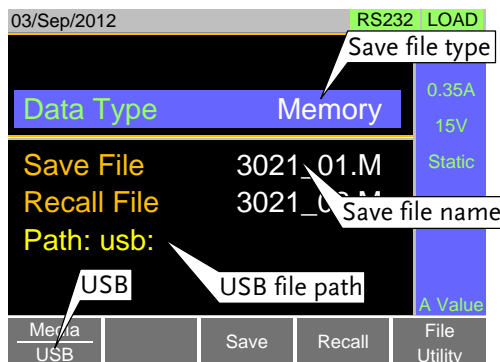

Operation

1. Insert a USB drive into the USB port.
2. Press **Shift** + **File FUNC**.
3. Select *USB* with the *Media[F1]* soft-key.
4. Select the *Data Type* and choose the type of file to recall.
Data Type: Memory Data, Setup Data, Preset Data, NSeq, FSeq
5. Select *Recall File* and choose a filename.
 - Turn the scroll wheel to increase/decrease the file number.

Memory: Model_file number.M
 Setup Memory: Model_file number.S
 Preset: Model_file number.P
 NSeq: Model_file number.N
 FSeq: Model_file number.F

6. Press *Recall*[F4] to recall.
 - Recall Ok will be displayed when the recall has been completed.

File Utilities Press *File Utility*[F5] to access the file utility. See page 131 for details.

- Change the USB path.
- Rename files or create directories.

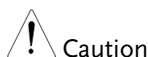

Caution

If “Machine Type Error” is displayed it indicates that the file that you are trying to recall originated from a different model. You can only recall files from the same model.

Recall Memory Safety Setting

Description By default when you try to recall *preset settings* from internal memory, a message will appear asking you to press the Enter key to confirm. This is the standard safety measure to ensure that the wrong setting is not recalled. This safety measure can be disabled by setting the Mem. Recall setting to “Direct”.

Operation

1. Press  > *Configure*[F5] > *Other*[F2] and set the *Mem. Recall* setting.

Range: Safety, Direct



Note

This setting only applies when recalling preset settings from internal memory, either by using the Presets keys (P0 ~ P9) or by using the File menu. See page 134 and 128.

File Utility

Description The file utility allows you to create new folders, rename files and set the USB path directory.

It is only available for use with the USB external memory.

Display

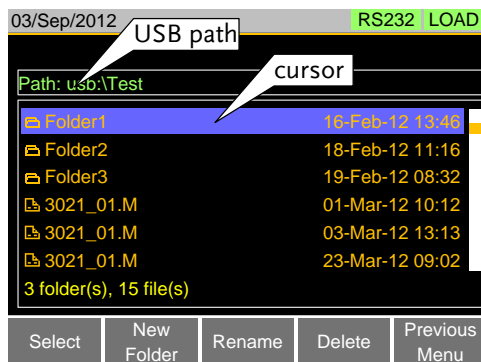

Access the File Utilities Menu

1. Insert a USB drive into the USB port.

2. Press **Shift** + **File FUNC** > *File Utility*[F5].
 - The file utilities screen appears.

Create a new Folder

1. Press *New Folder*[F2] to create a new folder.
 - Use the on-screen display to enter the filename.
 - A maximum of 8 characters.

- Rename a Folder
1. Use the scroll wheel to move the cursor to the file/folder you wish to rename.
 2. Press *Rename*[F3].
 - Use the on-screen display to enter the filename.
 - A maximum of 8 characters.
-



- Delete File or Folder
1. Use the scroll wheel to move the cursor to the file/folder you wish to delete.
 2. Press *Delete*[F4].
 3. Press *Delete*[F4] again to confirm the deletion.

Preset

The Preset key is used to save and recall preset settings from the front panel quickly. The presets have the same contents as memory data, this includes the operating mode, range, configuration settings and Go-NoGo settings.





Quick Preset Save

Description The current settings can be saved to P0 ~ P9 using the Preset key and the number pad.

- Operation
1. Press  and hold  ~  until a beep is heard.
 - The beep indicates that the setting was saved to the selected preset.

Quick Preset Recall



Description Presets P0 to P9 can be recalled quickly by using the Preset key and the number pad.

- Operation
1. Press  +  ~ .
 2. Press  to confirm the recall when a popup window appears.
 3. Press  again to deactivate the preset key.

Default Settings



Factory Default Settings



Description The factory default settings can be recalled at any time. See page 181 for a list of the factory default settings.

- Operation
1. Press  + .
 2. Select Default with the *Media*[F1] soft-key.
 3. Press *Factory Default*[F2].
 4. Press *Factory Default*[F2] again to confirm.

User's Default Setting

Description The currently active settings can be set as the "User's Default" settings.

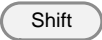
- Save User's Default Setting
1. Press  + .
 2. Select *Default* with the *Media[F1]* soft-key.
 3. Press *Save[F3]*.
- The User's Default is saved immediately.
-

- Recall User's Default Setting
1. Press  + .
 2. Select *Default* with the *Media[F1]* soft-key.
 3. Press *Recall[F4]*.
 4. Press *Recall[F4]* again to confirm.
- A User's Default must be saved first before it can be recalled.

E EXTERNAL CONTROL

Analog Control	137
J1 Connector Overview	137
External Voltage Control - Overview	138
External Voltage Control – Operation.....	139
External Resistance Control - Overview	141
External Resistance Control – Operation.....	143
Turning the Load On using External Control.....	146
Load On/Off Status	148
External Control of the Range.....	148
I Range Status	149
External Trigger Signal.....	150
External Control of the Alarm.....	151
Alarm Status.....	152
Short Control.....	152
Monitor Signal Output.....	153
Trigger Signal Output	153
Current Monitor Output.....	153
Parallel Operation	155
Parallel Capacity, PEL-3021, PEL-3041, PEL-3111	155
Parallel Capacity, PEL-3211	156
Connection	156
Configuration	158
Turning the Load On.....	160
Disable Parallel Mode	161

Analog Control

The Analog Control subsection describes how to use the J1 Frame Control Connector for voltage or resistance control. The J2 connector, located under the J1 connector is used for parallel control. See page 184 for the details J1 and J2 connectors.

J1 Connector Overview

Description The J1 External Control Connector is a standard Mil 20 pin connector (OMRON XG4A IDC plug). The connector is used for all analog control. The pins are used to determine what mode is used.

See the appendix on page 184 to view the contact pin assignment of the J1 connector.

 **WARNING**

Some pins on the frame control connector have the same potential as the front and rear terminals.

To prevent electric shock, ensure that the cover for both the J1 and J2 External Control connectors are used when the connectors are not in use.

Pin Assignment

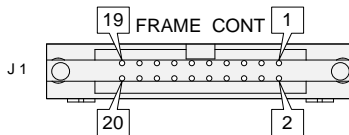

External Voltage Control - Overview

Background External voltage control of the CC, CR, CV and CP mode is accomplished using the J1 connector on the rear panel. An input voltage of 0~10V corresponds to 0% ~ 100% of the rated current (CC mode), rated voltage (CV mode), or rated power (CP mode). For CR mode, 0V ~ 10V corresponds to the maximum resistance ~ minimum resistance.

Connection When connecting the external voltage source to the J1 connector, use a ferrite core and use twisted pair wiring.

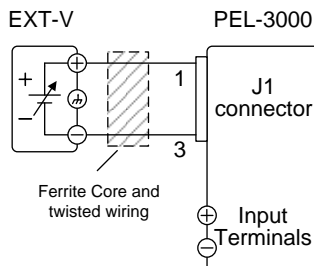

- Pin1 → EXT-V (+)
 - Pin3 → EXT-V (-)
-



The input impedance for external voltage control is 10kΩ.

Use a stable voltage supply for the external voltage control.



Caution

When using external voltage control, make sure no more than $\pm 11V$ is applied across pins 1 and 3. Exceeding this voltage could damage the PEL-3000. Exceeding 11.8V will cause an EXT.OV alarm message to appear which also will reset the voltage output to 0V until the external voltage is reduced back down below 11.8V.

Use caution when using pin 3. Pin 3 is directly coupled to the negative input terminal.

External Voltage Control – Operation

Description External voltage control can be used to control the current, voltage, resistance and power for CC, CR, CV and CP modes. Configuration for each operating mode is the same.

CC Mode Input current = rated current \times (external voltage/10)

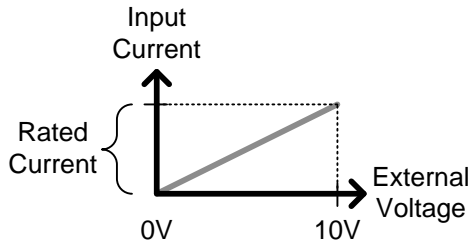

CR Mode Input conductance =
 rated conductance × (external voltage/10)

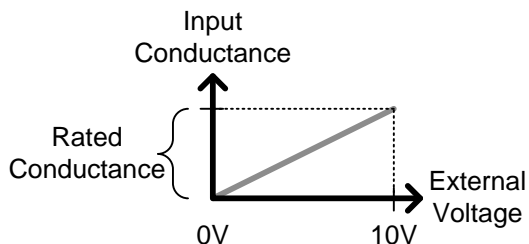

CV Mode Input voltage = rated voltage × (external
 voltage/10)

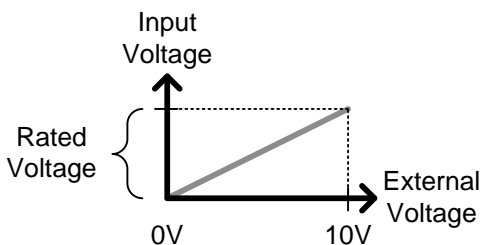

CP Mode Input power = rated power × (external
 voltage/10)

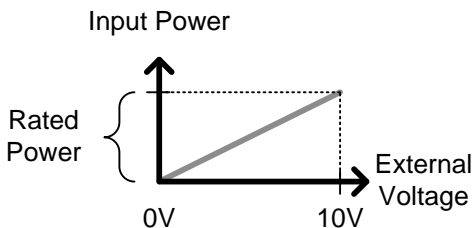

- Operation
1. Turn the power off from the PEL-3000 and from the load.
 2. Connect the external voltage across pins 1 and 3 of the J1 connector.

3. Turn the power on the PEL-3000.
4. Set the operating mode and range.
 - See page 53 for CC mode.
 - See page 55 for CR mode.
 - See page 57 for CV mode.
 - See page 58 for CP mode.
5. Press  > *Configure [F5]* > *Next Menu [F4]* > *External [F3]*.
6. Set the *Control* parameter to V.
 - The J1 connector is now ready for external voltage control.

External Resistance Control - Overview

Background

External resistance control of the CC, CR, CV and CP modes is accomplished using the J1 connector on the rear panel.

A resistance of $0\text{k}\Omega\sim 10\text{k}\Omega$ is used to control the input current, voltage, resistance or power on the PEL-3000.

The input can be configured to vary in proportion to the external resistance or the inverse. See page 143 for more details on proportional and inverse resistance control.



Note

Exceeding $11.8\text{k}\Omega$ will cause an EXT.OV alarm message which will reset the voltage output to 0 until the external resistance is reduced back down below $11.8\text{k}\Omega$.

Connection

When connecting the external resistance source to the J1 connector, use a ferrite core and use twisted pair wiring.

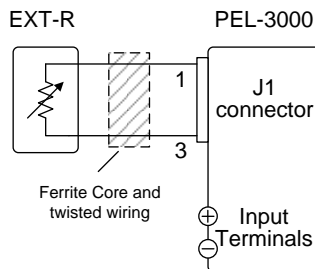

- *Pin1* → *EXT-R*
- *Pin3* → *EXT-R*



Use resistors with minimum residual resistance of 50Ω or less.

Note for proportional control: Do not use switches that switch between fixed resistances. Please use continuously variable resistors.

External Resistance Control – Operation

Description External resistance control can be used to control the current, voltage, resistance and power for CC, CR, CV and CP modes. Configuration for each operating mode is the same.

CC Mode

Proportional Control:
Input current = rated current \times (external resistance/10).

Inverse Control:
Input current = rated current \times (1 - external resistance/10).

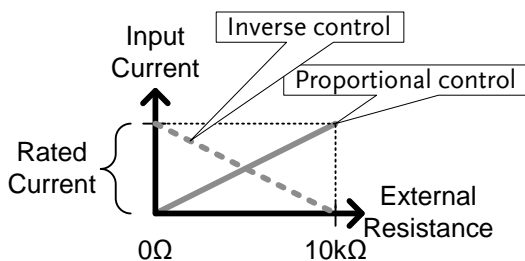

CR Mode

Proportional Control:

Input conductance =
 rated conductance \times (external resistance/10).

Inverse Control:

Input conductance =
 rated conductance \times (1 - external resistance/10).

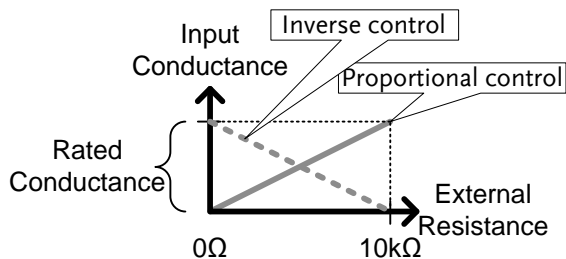

CV Mode

Proportional Control:

Input voltage = rated voltage \times (external resistance/10).

Inverse Control:

Input voltage = rated voltage \times (1 - external resistance/10).

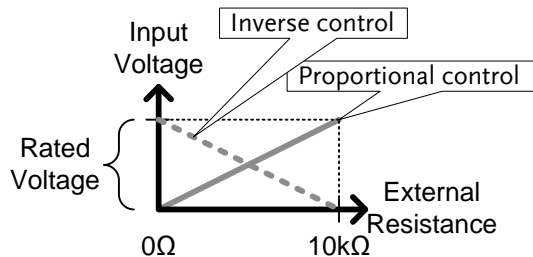

CP Mode

Proportional Control:

Input power = rated power \times (external resistance/10).

Inverse Control:

Input power = rated power \times (1 - external resistance/10).

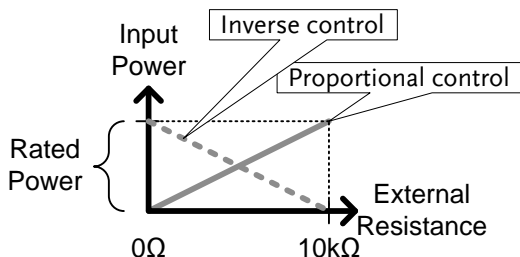

Note

The inverse configuration is recommended for safety reasons. In the event that any of the cables become accidentally disconnected, the current/voltage/power input will drop to the minimum. Under similar circumstances using proportional control, an unexpectedly high input would result.

Operation

1. Turn the power off from the PEL-3000 and from the load.
2. Connect the external resistance across pins 1 and 3 of the J1 connector.
3. Turn the power on the PEL-3000.
4. Set the operating mode and range.
 - See page 53 for CC mode.
 - See page 55 for CR mode.
 - See page 57 for CV mode.
 - See page 58 for CP mode.

5. Press **Main** > *Configure* [F5] > *Next Menu* [F4] > *External* [F3].
6. Set the *Control* to *R* for proportional control or to *Rinv* for inverse control.
 - The J1 connector is now ready for external resistance control.

Turning the Load On using External Control

Description	The load can be turned on and off with an external switch connected to pins 7 and 12 of the J1 connector.
Pin Inputs	Pin 7 of the J1 connector is internally pulled up to 5V with a 10kΩ resistor when the switch is open. Thus when the switch is open, pin 7 is logically high. When the switch is closed, pin 7 is pulled down to the A COM ground level, making pin 7 logically low.

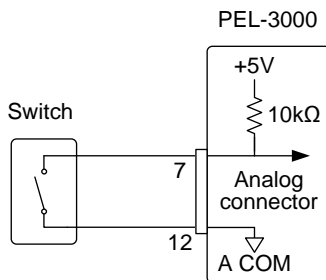

Example

The LoadOn IN setting determines whether the load is turned on when the external switch is closed (low) or open (high).

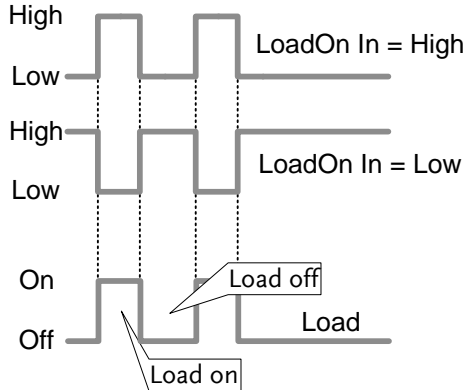

Operation:
Configuration

1. Press **Main** > *Configure [F5]* > *Next Menu [F4]* > *External [F3]* and set the *LoadOn IN* setting.
 - Set to Low if you want the load to be turned on when the switch is closed.
 - Set to High if you want the load to turn on when the switch is open.



When external control is used to turn the load off, the load key cannot be used to turn the load on. However the reverse is not true. If the load has been turned on by external control, the load key can be used to turn the load off.

Load On/Off Status

Description Pin 13 (Load On Status) of the J1 connector is used to monitor the load status (on or off).

Pin out The Load On Status pin is a photo-coupled open-collector output.

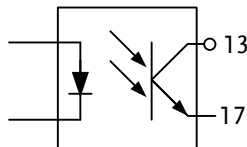

Photocoupler input: 30V max, 8mA, max.

External Control of the Range

Description The range for the present operating mode can be externally controlled when the current range is set to high range.

The range is changed using pins 8, 9 (Range Cont 1 &2) and 12 (A Com) of the J1 connector.

When externally controlling the range, the pin input combination determines which range is chosen.

Note: Press **Main** > *Configure [F5]* > *Next Menu [F4]* > *External [F3]* and set the *Control* setting to *V*, *R* or *Riv* to enable external control.

I Range	Pin 9	Pin 8
H	High	High
M	High	Low
L	Low	High

Pin Inputs

Pins 8 and 9 of the J1 connector are internally pulled up to 5V with a 10kΩ resistor when open. When closed, pin 8 and 9 are pulled down to the A COM ground level.

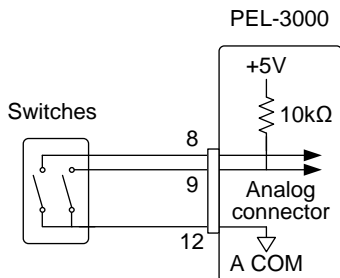

Note

The range can only be externally controlled when the IRange has been set to High using the front panel controls.

I Range Status

Description

Pins 14 and 15 (Range Status 1&2) of the J1 connector are used to monitor the IRange status.

The pinout combination determines the range status.

I Range	Pin 15	Pin 14
H	Off	Off
M	Off	On
L	On	Off

Pin out The Range Status pins are photo-coupled open-collector outputs.

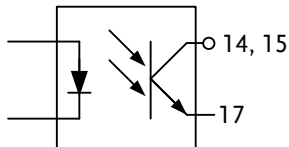

Photocoupler input: 30V max, 8mA, max.

External Trigger Signal

Description Pins 11 and 12 of the J1 connector are the trigger signal inputs. The trigger signal is used to resume a sequence after a pause. This action is useful to synchronize the execution of a sequence with another device.

Pin out Pin 11 of the J1 connector is internally pulled down to A COM with an approx. 50kΩ resistor. To use the trigger input, an active low TTL pulse of 10μs or more is required.

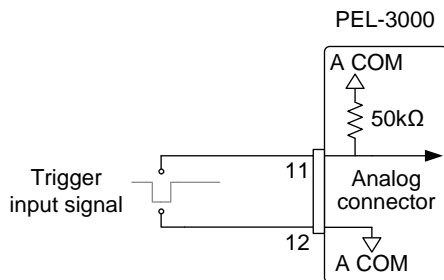

External Control of the Alarm

Description An alarm can be activated/deactivated using external control with the J1 connector (pins 10, 12). When the alarm is activated, an EXT.AL message is also output. The alarm can be activated by an external device or by a parallel slave unit.

The alarm is activated by sending a low-level signal. The operating threshold level is TTL.

Pin Inputs Pin 10 is internally pulled up to 5V with a 10k Ω resistor when open. When closed, pin 10 is pulled down to the A COM ground level.

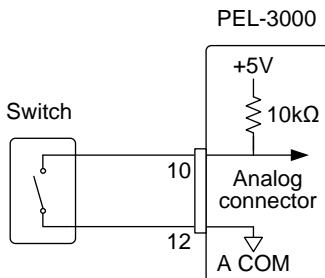

Alarm Status

Description Pins 16 and 17 of the J1 connector are used to monitor whether the alarm is on or off.

Pin out The Alarm Status pin is a photo-coupled open-collector output.

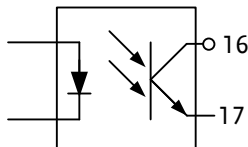

Photocoupler input: 30V max, 8mA, max.

Short Control

Description The Short Signal Out pins (19 and 20) are 30VDC 1A relay contact outputs. These outputs can be used to drive an external relay to physically short the terminal outputs.

Pin Inputs The Short Signal Out pins are normally open until the short function is activated.

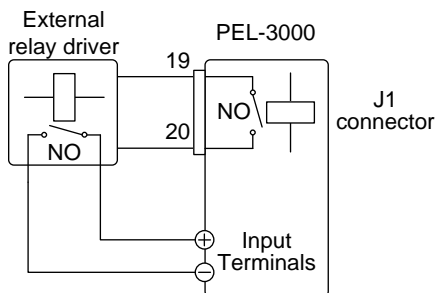

Note

The external relay driver is not a standard accessory. Please provide your own external relay and driver circuit.

Monitor Signal Output

Trigger Signal Output

Description The trigger output signal is generated every time a switching operation is performed (i.e., Dynamic mode) or when a Fast or Normal Sequence is executed and the TRIG OUT parameter is enabled.

The trigger output signal from TRIG OUT BNC is a 5V pulse of at least 2 μ s with an impedance of 500 Ω . The common potential is connected to the chassis potential. The signal threshold level is TTL.

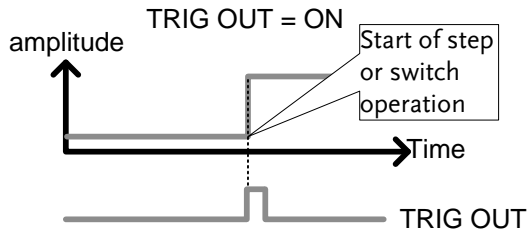

Current Monitor Output

Description The voltage output from the IMON OUT terminal and from the IMON pin on the J1 connector is used to represent the current input level.

The voltage range used to represent the full scale current range from the IMON OUT terminal and from the IMON pin on the J1 connector depends on the current range

settings.

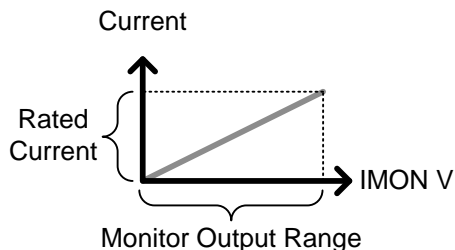

Monitor Connector	Current Range	Monitor Output Range
I MON OUT (BNC)	H, L	0 ~ 1V
	M	0 ~ 0.1V
I MON (J1)	H, L	0 ~ 10V
	M	0 ~ 1V

I MON OUT BNC Connector

The IMON OUT BNC connector outputs a voltage of 0 ~ 1V for the High and Low current ranges and 0 ~ 0.1V for the Middle current range. The common potential is connected to the chassis ground potential.

J1 Connector

The voltage across pins 2 and 3 outputs a voltage of 0 ~ 10V for the High and Low current ranges and 0 ~ 1V for the Middle current range. The common potential is connected to A COM (negative load terminal).

Parallel Operation

The PEL-3000 series can be connected in parallel to increase the total power capacity of a single unit.

The PEL-3000 series can operate with up to 5 units in parallel. A single unit is designated as a master unit and any other connected units as slaves.

Only units of the same type and rating can be used in parallel or alternatively, the PEL-3211 booster pack can be used as a slave with the PEL-3111.

When a master unit is used in parallel mode, to ensure stability, the response speed will drop down to 1/2 if it was originally 1/1. You can however, reset the response speed back (or to another value) in the Main>Configure menu.

Parallel Capacity, PEL-3021, PEL-3041, PEL-3111

Model	Single Unit	2 Units	3 Units	4 Units	5 Units
PEL-3021	150V	150V	150V	150V	150V
	35A	70A	105A	140A	175A
	175W	350W	525W	700W	875W
PEL-3041	150V	150V	150V	150V	150V
	70A	140A	210A	280A	350A
	350W	700W	1050W	1400W	1750W
PEL-3111	150V	150V	150V	150V	150V
	210A	420A	630A	1680A	1050A
	1050W	2100W	3150W	4200W	5250W

Parallel Capacity, PEL-3211

Model	No. of Units	V	I	Total Sink Current PEL-3111 + PEL-3211	Total Power PEL-3111 + PEL-3211
PEL-3111: Master	x 1	150V	210A	N/A	N/A
	x 1	150V	420A	630A	3150W
PEL-3211: Slave Boosters	x 2	150V	840A	1050A	5250W
	x 3	150V	1260A	1470A	7350W
	x 4	150V	1680A	1890A	9450W

Note: The PEL-3211 booster packs do not have a control panel. They can only be used as slaves with a single PEL-3111 in parallel.

Connection

Description The J1 and J2 connectors are used for control during parallel operation. Up to 5 units can be used in parallel.



Note

Only the rear panel terminals can be used for parallel operation, the front panel terminals have a lower current rating and thus should not be used for parallel operation.

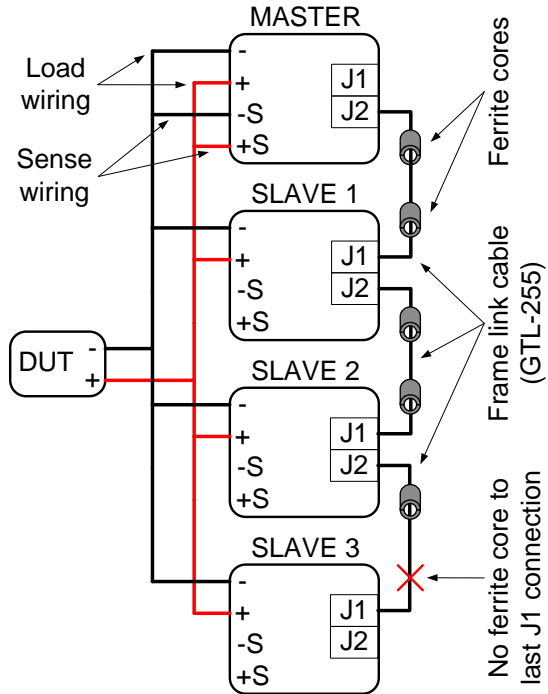

 **Cautions**

Only the rear terminals can be used for parallel connections.

Make sure all connections are correct before turning on the load. Incorrect connections could damage the units.

Only units of the same type and rating can be used in parallel (except for when the PEL-3211 booster pack is used with the PEL-3111).

Ensure that wiring of sufficient gauge is used when using parallel connections.

If using voltage sense, only connect the master to the voltage sense terminals.

Configuration

Description	When using the multiple units in parallel all the basic settings are adopted from the master unit.
-------------	--

- | | |
|-----------|--|
| Operation | <ol style="list-style-type: none">1. Make sure all load units are turned off.2. Make sure the DUT is turned off.3. Connect the load units to the DUT.<ul style="list-style-type: none">• Ensure the wire gauge is sufficient to handle the increase in current4. Connect the Master unit to the slave units via the J1/J2 connectors*.<ul style="list-style-type: none">• Use the GTL-255 frame link cables• Connect from:
Master J2 → Slave1 J1
Slave1 J2 → Slave2 J1 and so on.• Remove one ferrite core from the last frame link cable. Remove the ferrite core that is closest to the J1 port on the last slave unit. See the diagram below for details.5. Turn the load units on.6. On the designated master unit, press  > <i>Configure</i> [F5] > <i>Next Menu</i> [F4] > <i>Parallel</i>[F1].7. Set the unit to <i>Master</i> with the <i>Operation</i> setting.8. Assign the number of attached slave units or booster units with the <i>Parallel</i> and <i>Booster</i> settings. |
|-----------|--|
-

- A maximum of 5 units can be used in parallel.
- A maximum of 4 boosters can be used with a single PEL-3111, acting as a master unit.

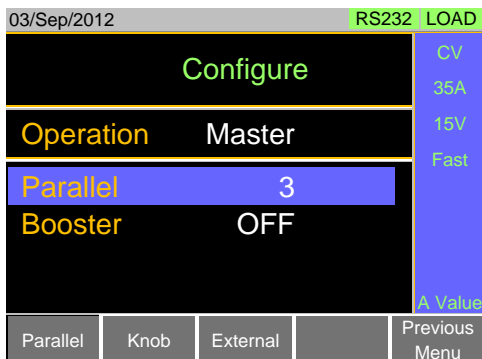

- On the slave units, press **Main** > *Configure* [F5] > *Next Menu* [F4] > *Parallel*[F1] > and set *Operation* to *Slave*.
- When in Slave mode, all keys are locked, except for the Scroll wheel and Enter key.

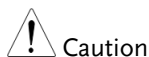

*Failing to remove the last ferrite core from the GTL-255 cable may reduce the stability of the units when used in parallel.

Turning the Load On

Description	Operating the PEL-3000 Series in parallel mode is the same as for single units.
-------------	---



Note

When using the units in parallel, the load line inductance could be increased or the stability of the units could be reduced. It may be necessary to reduce the response speed setting to increase stability.

1. Turn the slave and master units on.
2. Set the operation mode and settings on the master unit.
 - The master's settings will be used by the slave units.
3. Turn the load on from the Master unit.
 - All measurements will be displayed and updated on the Master unit only.

Disable Parallel Mode

Description	To disable parallel mode, each unit must be set as a "Master".
Operation	<ol style="list-style-type: none">1. Turn the power off on all the units and remove the GTL-255 frame link cables.2. Turn the power back.3. On each unit, press  > <i>Configure [F5]</i> > <i>Next Menu [F4]</i> > <i>Parallel[F1]</i>.4. Set the unit to <i>Master</i> with the <i>Operation</i> setting.5. Turn the <i>Parallel</i> and <i>Booster</i> settings to <i>Off</i>.

REMOTE CONTROL

This chapter describes basic configuration of IEEE488.2 based remote control. For a command list, refer to the programming manual, downloadable from GW Instek website, www.gwinstek.com

Interface Configuration	163
Configure to USB Remote Interface.....	163
Configure GPIB Interface.....	163
Configure RS232C.....	165
RS232C/USB Remote Control Function Check.....	166
Using Realterm to Establish a Remote Connection.....	167
GPIB Function Check	171

Interface Configuration



Configure to USB Remote Interface

USB configuration	PC side connector	Type A, host
	PEL-3000 side connector	Rear panel Type B, slave
	Speed	2.0 (full speed)
	USB Class	USB CDC ACM



Note

Before USB can be used for remote control, it is necessary to install the PEL-3000 USB device driver, located on the accompanying User Manual CD.

- Operation
1. Connect the USB cable to the rear panel USB B port.
 2. Press  +  > *Interface*[F3] and set the *Interface* setting to *USB*.

Configure GPIB Interface

To use GPIB, the optional GPIB port must be installed. See page 180 for installation details.

- Operation
3. Ensure the PEL-3000 is off before proceeding.

4. Connect a GPIB cable from a GPIB controller to the GPIB port on the PEL-3000.

5. Turn the PEL-3000 on.

6. Press **Shift** + **Utility Help** > *Interface[F3]* and set the *Interface* setting to *GPIB*.

7. Set the GPIB address.

GPIB address 0~30

- GPIB constraints
- *Maximum 15 devices altogether, 20m cable length, 2m between each device*
 - *Unique address assigned to each device*
 - *At least 2/3 of the devices turned On*
 - *No loop or parallel connection*

Pin Assignment

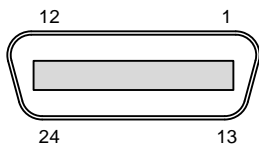

Pin	Signal	Pin	Signal
1~4	Data I/O 1~4	13~16	Data I/O 5~8
5	EOI	17	REN
6	DAV	18	Ground (DAV)
7	NRFD	19	Ground (NRFD)
8	NDAC	20	Ground (NDAC)
9	IFC	21	Ground (IFC)
10	SRQ	22	Ground (SRQ)
11	ATN	23	Ground (ATN)
12	SHIELD Ground	24	Single GND

Configure RS232C

RS232C Configuration	Connector	DB-9, Male
	Baud Rate	2400, 4800, 9600, 19200, 38400
	Stop Bit	1, 2
	Parity	None, Odd, Even

- Operation
1. Connect an RS232C cable from the PC to the rear panel RS232 port.
 2. Press **Shift** + **Help** ^{Utility} > *Interface*[F3] and set the *Interface* setting to RS232.
 3. Set the *Baud Rate*, *Stop Bit* and *Parity* settings.

Pin Assignment

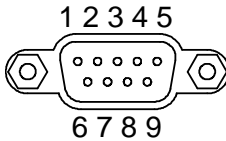

- 2: RxD (Receive data)
- 3: TxD (Transmit data)
- 5: GND
- 4, 6 ~ 9: No connection

PC Connection Use a null modem connection as shown in the diagram below.

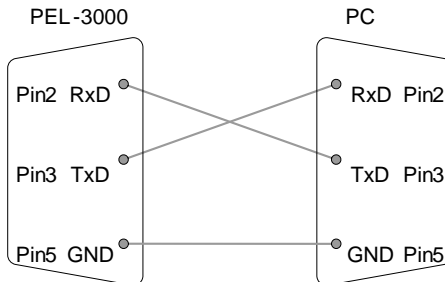

RS232C/USB Remote Control Function Check

Functionality
check

Invoke a terminal application such as Realterm.

For RS-232C, set the COM port, baud rate, stop bit, data bit and parity accordingly.

To check the COM settings in Windows, see the Device Manager. For example, in WinXP go to the Control panel → System → Hardware tab.



Note

If you are not familiar with using a terminal application to send/receive remote commands from the serial port or via a USB connection, please page 167 (Using Realterm to Establish a Remote Connection) for more information.

Run this query command via the terminal after the instrument has been configured for RS-232/USB remote control (page 165).

*idn?

This should return the Manufacturer, Model number, Serial number, and Firmware version in the following format.

- *GW-INSTEK, PEL-3000, XXXXXXXXXXXXX, V.X.X.X*

Manufacturer: GW-INSTEK

Model number : PEL-3000

Serial number : XXXXXXXXXXXXX

Firmware version : V.X.X.X



Note

For further details, please see the programming manual, available on the GW Instek web site @ www.gwinstek.com.

Using Realterm to Establish a Remote Connection

Background Realterm is a terminal program that can be used to communicate with a device attached to the serial port of a PC or via an emulated serial port via USB.

The following instructions apply to version 1.99.0.27. Even though Realterm is used as an example to establish a remote connection, any terminal program can be used that has similar functionality.



Note

Realterm can be downloaded on Sourceforge.net free of charge.

For more information please see <http://realterm.sourceforge.net/>

- Operation**
1. Download Realterm and install according to the instructions on the Realterm website.
 2. Connect the PEL-3000 via USB (page 163) or via RS232 (page 165).
 3. If using RS232, make note of the configured baud rate, stop bits and parity.
 4. Go to the Windows device manager and find the COM port number for the connection. For example, go to the Start menu > Control Panel > Device Manager

Double click the *Ports* icon to reveal the connected serial port devices and the COM port for the each connected device.

If using USB, the baud rate, stop bit and parity settings can be viewed by right-clicking connected device and selecting the *Properties* option.

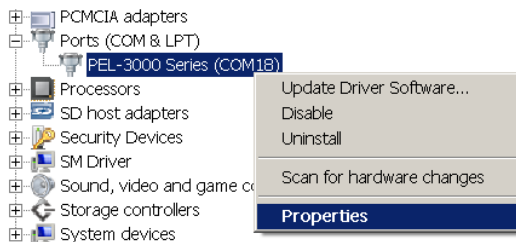

5. Start Realterm on the PC as an administrator.
Click:
Start menu>All Programs>RealTerm>realterm

Tip: to run as an administrator, you can right click the Realterm icon in the Windows Start menu and select the *Run as Administrator* option.

6. After Realterm has started, click on the *Port* tab.

Enter the *Baud*, *Parity*, *Data bits*, *Stop bits* and *Port* number configuration for the connection.

The *Hardware Flow Control*, *Software Flow Control* options can be left at the default settings.

Press *Open* to connect to the PEL-3000.

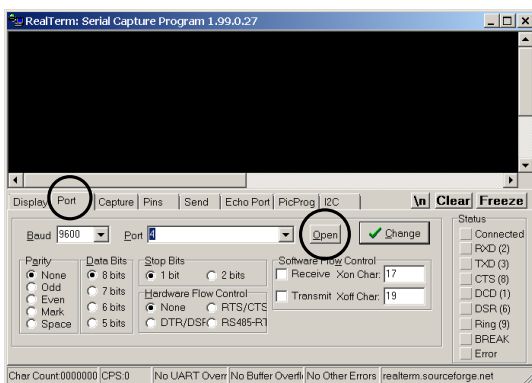

- Click on the *Send* tab.

In the *EOL* configuration, check on the *+CR* and *+LF* check boxes.

Enter the query:

**idn?*

Click on *Send ASCII*.

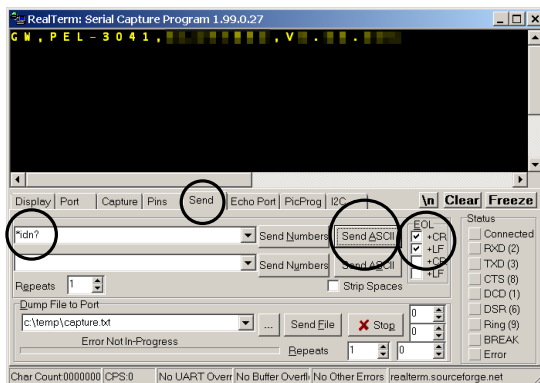

- The terminal display will return the following:

GW, PEL-3XXX,EXXXXXXXXX,VX.XX.XXX

(manufacturer, model, serial number, version)

- If Realterm fails to connect to the PEL-3000, please check all the cables and settings and try again.

GPIB Function Check

Functionality check Please use the National Instruments Measurement & Automation Controller software to confirm GPIB/LAN functionality.

See the National Instrument website, <http://www.ni.com> for details.



Note

For further details, please see the programming manual, available on the GW Instek web site @ www.gwinstek.com.

Operation

1. Start the NI Measurement and Automation Explorer (MAX) program. Using Windows, press:



Start>All Programs>National Instruments>Measurement & Automation

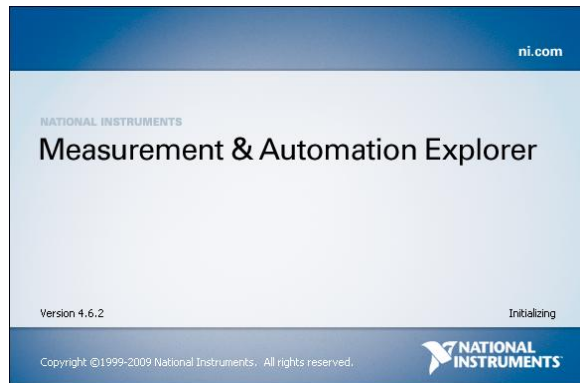

2. From the Configuration panel access; *My System>Devices and Interfaces>GPIB0*

3. Press the *Scan for Instruments* button.
4. In the *Connected Instruments* panel the PEL-3000 should be detected as *Instrument 0* with the address the same as that configured on the PEL-3000.
5. Double click the *Instrument 0* icon.

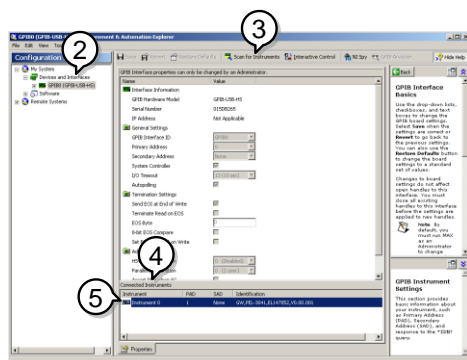

6. Click on *Communicate with Instrument*.
7. In the *NI-488.2 Communicator* window, ensure **IND?* is written in the *Send String:* text box.

Click on the *Query* button to send the **IDN?* query to the instrument.

8. The *String Received* text box will display the query return:

GW, PEL-3XXX, EXXXXXXXXX, VX.XX.XXX
(manufacturer, model, serial number, version)

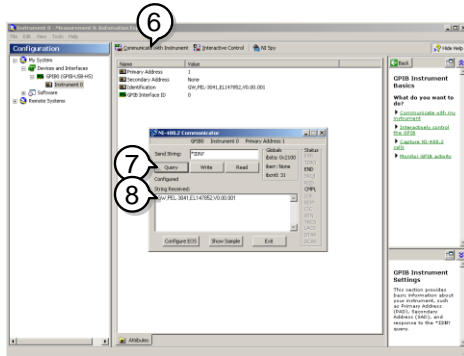

9. The function check is complete.

FAQ

-
- The load voltage indicated on the load module is below expected.
 - The front panel keys are not working.
 - The load won't turn on.
 - The performance does not match the specification

The load voltage indicated on the load module is below expected.

Ensure the load leads are as short as possible, twisted and use the appropriate wire gauge. Ensure that voltage sense is used, this can help alleviate the voltage drop across the load the leads.

The front panel keys are not working.

Check to make sure that the key lock has not been activated. LOCK will be shown on the panel when the screen is locked. Press Shift + Lock to unlock the keys.

The load won't turn on.

If you are using the load key to try to turn the load on and the load won't turn on, it is possible that external control is activated and that the LoadOn In setting is set to low. See page 146 for details.

The performance does not match the specification.

Make sure the device is powered On for at least 30 minutes, within +20°C~+30°C. This is necessary to stabilize the unit to match the specification.

For more information, contact your local dealer or GWInstek at www.gwinstek.com / marketing@goodwill.com.

A PPENDIX

Replacing the Dust Filter	178
Replace the Clock Battery	179
GPIB Installation	180
PEL-3000 Default Settings	181
Frame Control Connector Contacts	184
Operating Mode Description	189
CC Mode.....	189
CR Mode.....	190
CP Mode.....	191
CV Mode.....	193
Operating Area	194
PEL-3000 Specifications	198
Rating (Master / Slave)	198
Rating (Booster / Slave).....	198
CC Mode.....	199
CR Mode.....	200
CV Mode.....	200
CP Mode.....	201
Slew Rate.....	202
Meter	202
Dynamic Mode.....	203
Soft Start	205
Remote Sensing.....	206
Protection Function	206
Sequence	206

Other	207
Analog External Control.....	208
Front Panel BNC Connector	209
General.....	209
PEL-3000 Dimensions	210
PEL-3111	210
PEL-3021, PEL-3041	211
PEL-3211	212
Declaration of Conformity	213

Replacing the Dust Filter

Background The dust filter should be replaced twice a year. Not replacing the filter will reduce performance and may cause the PEL-3000 to malfunction.

Procedure 1. Turn the PEL-3000 off completely at the rear panel power switch.

Gently lift the grill up from the bottom.

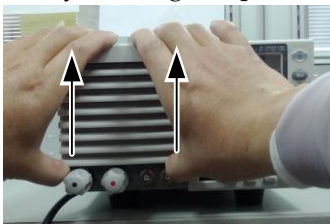

2. Remove the filter from the grill and replace with GW Instek part number: PEL-010.

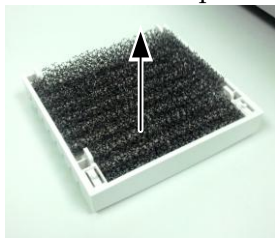

Replace the Clock Battery

Background	<p>The system clock keeps time using a user-replaceable battery.</p> <p>The battery should be replaced approximately every 3 years.</p> <p>Battery type: CR123A</p>
------------	---

- Procedure
1. Turn off the PEL-3000 and remove the case.
 - First remove the handle by carefully removing the plastic tabs and then unscrewing the two screws connecting the handle to the case.
 - A total of 10 screws should be removed from the case.
 2. Remove the battery and replace with the same type and rating.
 - The battery is located on the right hand side, near the rear panel.



GPIB Installation

Background GPIB is an optional extra. The following instructions describe how to install the optional GPIB card if necessary.

- Procedure**
1. Turn off the PEL-3000.
 2. Remove the two screws holding the cover on the option bay.
 3. Slide the GPIB card onto the rails in the option bay.
 4. Re-screw the screws back into place.
-

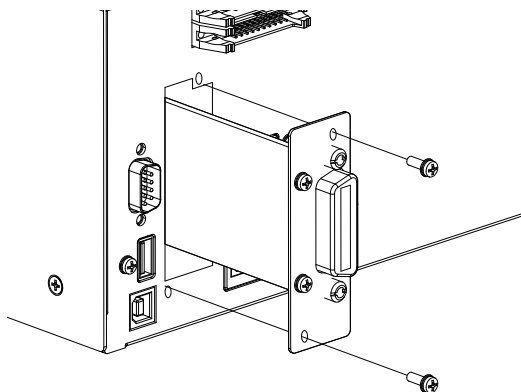

PEL-3000 Default Settings

The following default settings are the factory configuration settings for the PEL-3000.

Main Settings		
Item	Panel Settings	Setup Memory Settings (all 100 sets)
Current(CC)	0 A	0 A
Conductance(CR)	0 S	0 S
Voltage(CV)	Maximum value	Maximum value
Wattage(CP)	0 W	0 W
+CV	OFF	OFF
Current range	H	H
Voltage range	150 V	150 V
Load on/off	Load off	Load off
Operation mode	CC	CC
Slew rate	Maximum value of H range	Maximum value of H range
Preset memories	Settings above in each mode	Settings above in each mode
Main > Configure > Protection		
Item	Panel Settings	Setup Memory Settings (all 100 sets)
OCV Level	Maximum value	Maximum value
OCV Setting	LIMIT	LIMIT
OPP Level	Maximum value	Maximum value
OPP Setting	LIMIT	LIMIT
UVP value	OFF	OFF
OVP value	OFF	OFF

Main > Configure > Other

Item	Panel Settings	Setup Memory Settings (all 100 sets)
Soft Start	OFF	OFF
Von Voltage	0.00V	0.00V
Von Latch	ON	ON
Von Delay	2.0 ms	2.0 ms
Short Key	Toggle	Toggle
Count Time(elapsed time display)	OFF	OFF
Cut Off Time	OFF	OFF
Response	1/1	1/1
Mem.Recall	Safety	Safety
Dyna. Level	Value	Value
Dyna. Time	T1/T2	T1/T2
CR Unit	mS	mS

Main > Configure > Go-NoGo

Item	Panel Settings	Setup Memory Settings (all 100 sets)
SPEC. Test	OFF	OFF
Delay Time	0.0s	0.0s
Entry Mode	Value	Value
High	Maximum Voltage / Maximum Current	Maximum Voltage / Maximum Current
Low	Minimum Voltage / Minimum Voltage	Minimum Voltage / Minimum Voltage

Main > Configure > Next Menu > Parallel

Item	Panel Settings	Setup Memory Settings (all 100 sets)
Operation	Master	Master
Parallel	OFF	OFF
Booster	OFF	OFF

Main > Configure > Next Menu > Knob

Item	Panel Settings	Setup Memory Settings (all 100 sets)
Status	Step	Step
CCH Step	Resolution	Resolution
CCM Step	Resolution	Resolution
CCL Step	Resolution	Resolution
CRH Step	Resolution	Resolution
CRM Step	Resolution	Resolution
CRL Step	Resolution	Resolution
CVH Step	Resolution	Resolution
CVL Step	Resolution	Resolution
CPH Step	Resolution	Resolution
CPM Step	Resolution	Resolution
CPL Step	Resolution	Resolution

Main > Configure > Next Menu > External

Item	Panel Settings	Setup Memory Settings (all 100 sets)
Control	OFF	OFF
LoadOn IN	OFF	OFF

Frame Control Connector Contacts

J1 Connector

Pin name	Pin number	Description
EXT R/V CONT	1	Used for voltage/resistance control of CC, CR, CV and CP mode. 0V to 10V corresponds to 0% to 100% of the rated current (CC mode), rated voltage (CV mode), or rated power (CP mode). 0V to 10V corresponds to the maximum resistance to minimum resistance (CR mode) 0Ω to 10kΩ corresponds to 0% to 100% or 100% to 0% of the rated current (CC mode), rated voltage (CV mode), or rated power (CP mode). 0Ω to 10kΩ corresponds to maximum resistance to minimum resistance or minimum resistance to maximum resistance (CR mode)
IMON	2	Current monitor output 10 V f.s (H/L range) and 1 V f.s (M range)
A COM	3	Connected to the negative load input terminal on the rear panel.
SUM I MON	4	Used during master/slave operation. Connected to SUM I MON of the J2 connector.
PRL IN+	5	Used during master/slave operation. Connected to PRL OUT+ of the J2 connector.
PRL IN-	6	Used during master/slave operation. Connected to PRL OUT- of the J2 connector.
LOAD ON/OFF CONT	7	Turns on the load with low (or high) TTL level signal Pulled up the internal circuit to 5 V using 10 kΩ.
RANGE CONT 1	8	External range switch input*1 *2
RANGE CONT 0	9	Pulled up the internal circuit to 5 V using 10 kΩ.
ALARM INPUT	10	Activates alarm with low TTL level signal input. Pulled up the internal circuit to 5 V using 10 kΩ.

TRIG INPUT	11	When paused, clears the pause when a low level TTL signal is applied for 10 μ s or longer. Pulled down the internal circuit to A COM using approx. 50k Ω .
A COM	12	Connected to the negative load input terminal on the rear panel.
LOAD ON STATUS	13	Turns on when load is on. Open collector output by a photocoupler.*4
RANGE STATUS 1	14	Range status output. Open collector output by a photocoupler.*4
RANGE STATUS 0	15	Range status output. Open collector output by a photocoupler.*4
ALARM STATUS	16	Turns on when an alarm (OVP, OCP, OPP, OTP, RVP, or UVP) is activated or when an external alarm is applied. Open collector output by a photocoupler.*4
STATUS COM	17	STATUS signal common for pins 13 to 16.
RESERVED	18	RESERVED.
SHORT SIGNAL OUT	19	Relay contact output (30 VDC/1 A)
SHORT SIGNAL OUT	20	

*1 Valid only when the front panel settings are H range.

*2	RANGE CONT 0	RANGE CONT 1
H range	1	1
M range	1	0
L range	0	1

*3	RANGE STATUS 0	RANGE STATUS 1
H range	OFF	OFF
M range	OFF	ON
L range	ON	OFF

*4 The maximum applied voltage of the photocoupler is 30 V; the maximum current is 8 mA.

J2 Connector

Pin name	Pin number	Description
N.C.	1	Not connected.
N.C.	2	Not connected.
N.C.	3	Not connected.
SUM I MON	4	Connect to SUM I MON of the J1 connector.
PRL OUT+	5	Used during master/slave operation. Connected to PRL IN+ of the J1 connector.
PRL OUT-	6	Used during master/slave operation. Connected to PRL IN- of the J1 connector.
LOAD ON/OFF CONT	7	
N.C.	8	Not connected.
SLAVE RANGE CONT	9	Used during master/slave operation. Connected to RANGE CONT 0 of the J1 connector.
N.C.	10	Not connected.
N.C.	11	Not connected.
A COM	12	Connected to the negative load input terminal on the rear panel.
N.C.	13	Not connected.
N.C.	14	Not connected.
N.C.	15	Not connected.
ALARM INPUT	16	Activates an alarm with high (or low) TTL level signal input. Pulled up the internal circuit to 5 V.
A COM	17	Connected to the negative load input terminal.
N.C.	18	Not connected.
A COM	19	Connected the negative load input terminal.
+15V	20	Controls the on/off of the load booster power (cannot be used for multiple purposes).

J1 Connector Booster

Pin name	Pin number	Description
N.C.	1	Not connected.
N.C.	2	Not connected.
A COM	3	Connected to the negative load input terminal.

SUM I MON	4	Connected to SUM I MON of the J2 connector.
PRL IN+	5	Connected to PRL OUT+ of the J2 connector.
PRL IN-	6	Connected to PRL OUT- of the J2 connector.
LOAD ON/OFF CONT	7	Turns on the load with low (or high) TTL level signal.
N.C.	8	Pulled up by the internal circuit to 5 V using 10 k Ω .
RANGE CONT 0	9	External range switch input*1 *2 Pulled up the internal circuit to 5 V using 10 k Ω .
ALARM INPUT	10	Activates an alarm with high (or low) TTL level signal input. Pulled up by the internal circuit to 5 V.
N.C.	11	Not connected.
A COM	12	Connected to the negative load input terminal on the rear panel.
N.C.	13	Not connected.
N.C.	14	Not connected.
N.C.	15	Not connected.
ALARM STATUS	16	Turns on when an alarm (OVP, OCP, OPP, OTP, RVP, or UVP) is activated or when an external alarm is applied. Open collector output by a photocoupler.*3
STATUS COM	17	STATUS signal common for pins 16.
N.C.	18	Not connected.
A COM	19	Connected to the negative load input terminal on the rear panel.
+15V	20	Controls the on/off of the load booster power (cannot be used for multiple purposes).

*1 Valid only when the front panel settings are H range.

*2	RANGE CONT 0
H range	1
M range	1

*3 The maximum applied voltage of the photocoupler is 30 V; the maximum current is 8 mA.

J2 Connector Booster

Pin name	Pin number	Description
N.C.	1	Not connected.
N.C.	2	Not connected.
N.C.	3	Not connected.
SUM I MON	4	Connect to SUM I MON of the J1 connector.
PRL OUT+	5	Used during master/slave operation. Connected to PRL IN+ of the J1 connector.
PRL OUT-	6	Used during master/slave operation. Connected to PRL IN- of the J1 connector.
LOAD ON/OFF CONT	7	
N.C.	8	Not connected.
SLAVE RANGE CONT	9	Used during master/slave operation. Connected to RANGE CONT 0 of the J1 connector.
N.C.	10	Not connected.
N.C.	11	Not connected.
A COM	12	Connected to the negative load input terminal on the rear panel.
N.C.	13	Not connected.
N.C.	14	Not connected.
N.C.	15	Not connected.
ALARM INPUT	16	Activates an alarm with high (or low) TTL level signal input. Pulled up by the internal circuit to 5 V.
A COM	17	Connected to the negative load input terminal.
N.C.	18	Not connected.
A COM	19	Connected to the negative load input terminal.
+15V	20	Controls the on/off of the load booster power (cannot be used for multiple purposes).

Operating Mode Description

CC Mode

CC Mode

When the unit is set to CC mode it will operate as a constant current load when connected to a constant voltage source. This means the unit will sink a designated amount of current, up to the rated power level, regardless of the voltage. This is illustrated below.

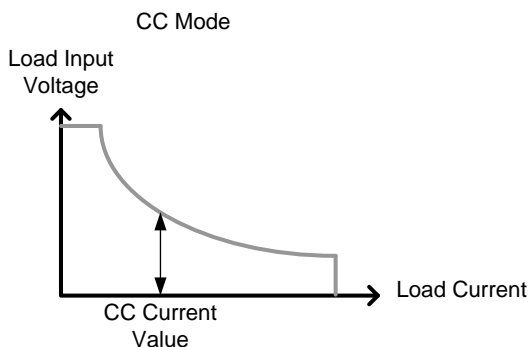

CC+CV Mode

When CC+CV mode is enabled, the unit will act as constant current load after the input voltage is greater than the user-defined CV level. At the CV level, the unit works as a constant voltage load. This mode effectively creates a voltage ceiling before the unit operates in CC mode. The diagram below illustrates this.

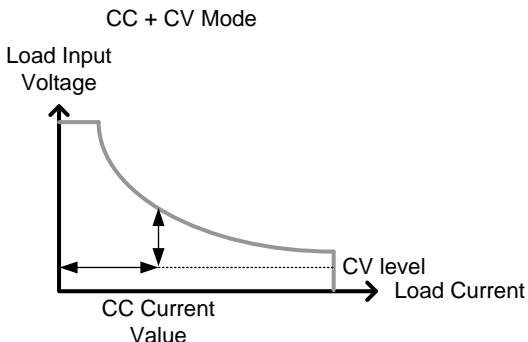

Note that when the source voltage is less than the CV level, no current will flow due to a very high impedance.

CR Mode

CR Mode

When the unit is set to CR mode it will operate as a constant resistance load when connected to a constant voltage source. This means the unit will maintain a set resistance, up to the rated power, regardless of the input voltage. When input voltage changes, the unit responds by changing the current load to maintain the set resistance according to ohm's law. This is illustrated below.

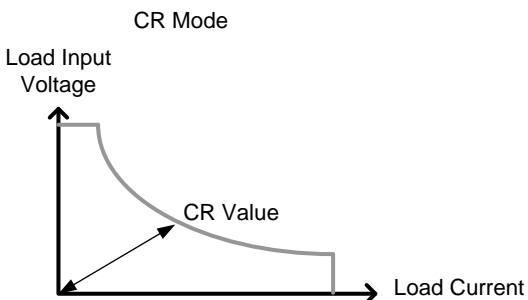

CR+CV Mode

When CR+CV mode is enabled, the unit will act as constant resistive load after the input voltage is greater than the user-defined CV level. At the CV level, the unit works as a constant voltage load. This mode effectively creates a voltage ceiling before the unit operates in CR mode. The diagram below illustrates this.

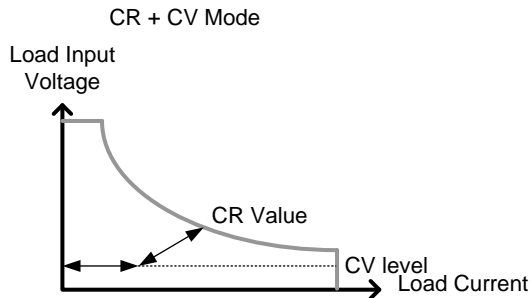

Note that when the source voltage is less than the CV level, no current will flow due to a very high impedance.

CP Mode

CP Mode

When the unit is set to CP mode it will operate as a constant power load when connected to a constant voltage source. This means the unit will maintain a set power level, up to the rated current or voltage level, regardless of the input voltage. When input voltage changes, the unit responds by changing the current load to maintain the set power level accordingly ($P=I \times V$). This is illustrated below.

CP Mode

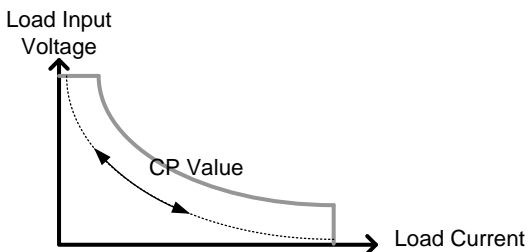

CP+CV Mode

When CP+CV mode is enabled, the unit will act as a constant power load after the input voltage is greater than the user-defined CV level. At the CV level, the unit works as a constant voltage load. This mode effectively creates a voltage ceiling before the unit operates in CP mode. The diagram below illustrates this.

CP+CV Mode

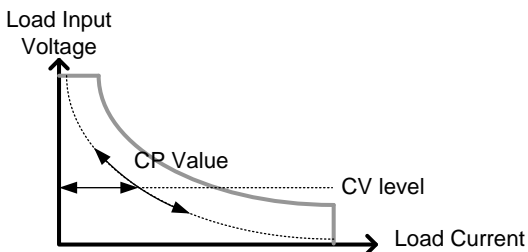

Note that when the source voltage is less than the CV level, no current will flow due to a very high impedance.

CV Mode

CV Mode

When the unit is set to CV mode it will operate as a constant voltage load when connected to a constant current source. This means the unit will maintain a set voltage level, up to the rated power, regardless of the input current. When the source voltage is less than the CV level, no current will flow due to a very high impedance. This is illustrated below.

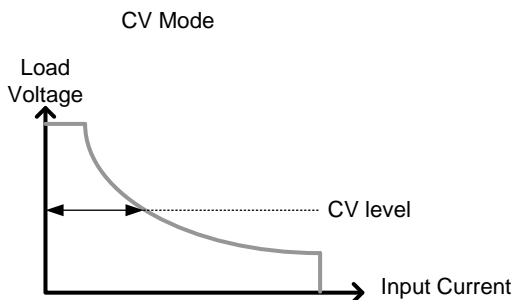

Operating Area

PEL-3021

PEL-3021 High Range Chart

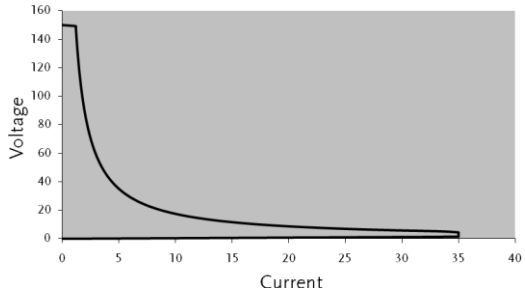

PEL-3021 Middle Range Chart

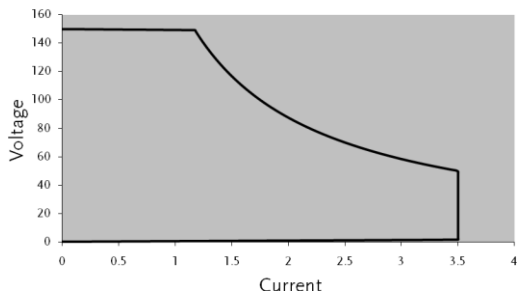

PEL-3021 Low Range Chart

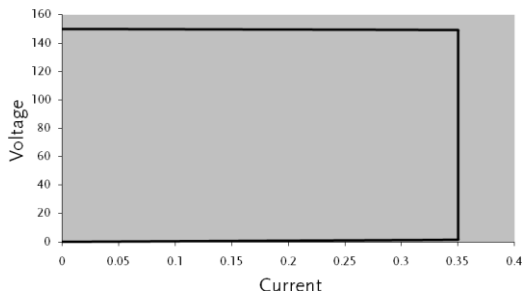

PEL-3041

PEL-3041 High Range Chart

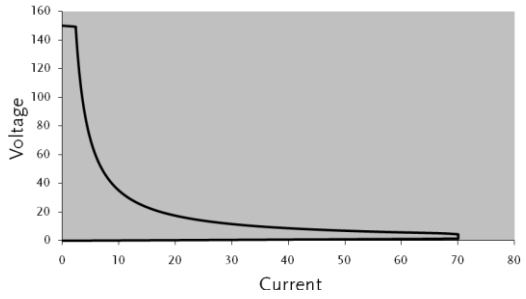

PEL-3041 Middle Range Chart

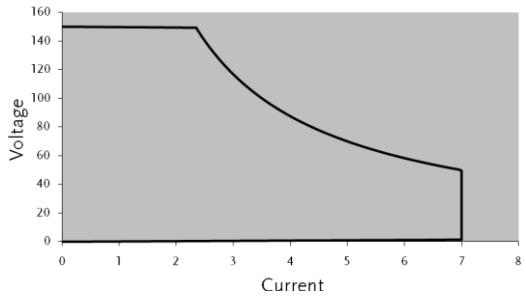

PEL-3041 Low Range Chart

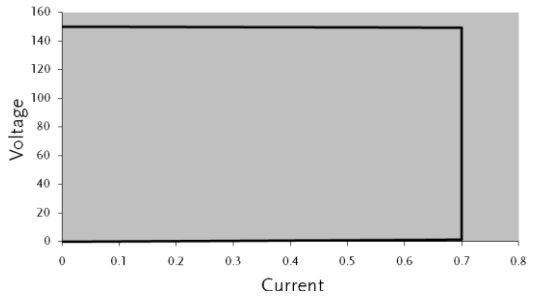

PEL-3111

PEL-3111 High Range Chart

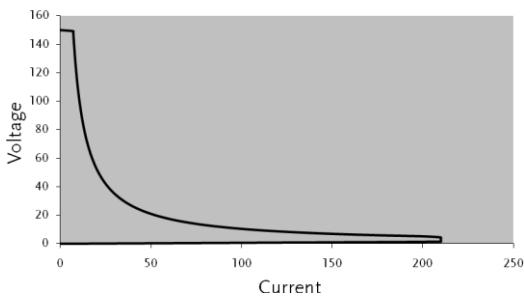

PEL-3111 Low Range Chart

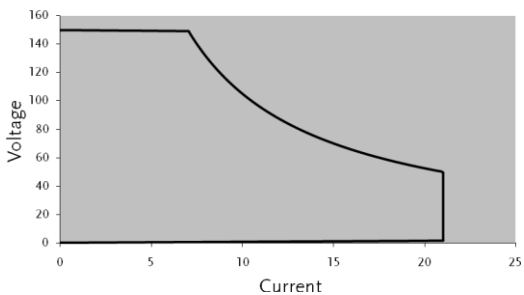

PEL-3111 Low Range Chart

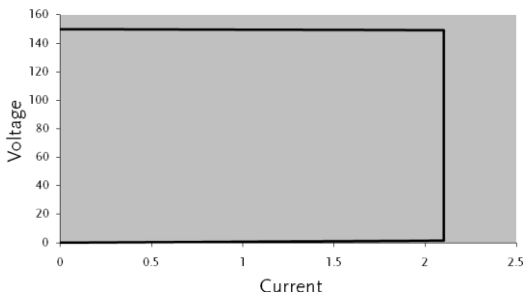

PEL-3211
Booster Pack

PEL-3211 High Range Chart

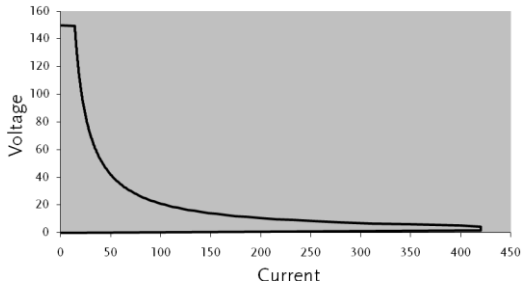

PEL-3000 Specifications

The specifications apply when the PEL-3000 is powered on for at least 30 minutes to warm-up to a temperature of 20°C to 30°C, unless specified otherwise.

All specifications apply when using the rear panel terminals. If the front panel terminals are used or if operating with long cables, remote sense must be connected to the terminals.

In parallel mode: All operation/settings/resolution specifications are xN. This does not include voltage settings and measured values. The maximum slew rate settings also don't change.

N = Number of units in parallel (same model)

N = 1 + 2 x Number of units in parallel (PEL-3211)

Rating (Master / Slave)

Model	PEL-3021	PEL-3041	PEL-3111
Operating Voltage	1.5V~150V	1.5V~150V	1.5V~150V
Current	35A	70A	210A
Power	175W	350W	1050W

Rating (Booster / Slave)

Model	PEL-3211
Operating Voltage	1.5V~150V
Current	420A
Power	2100W
Current Setting Accuracy	±(1.2% of set + 1.1% of f.s.)
	M range applies to the full scale of H range.
	Note: PEL-3211 only has H or M current ranges.

CC Mode

Model	PEL-3021	PEL-3041	PEL-3111
Operating Range			
H Range	0A~35A	0A~70A	0A~210A
M Range	0A~3.5A	0A~7A	0A~21A
L Range	0A~0.35A	0A~0.7A	0A~2.1A
Setting Range			
H Range	0A~35.7A	0A~71.4A	0A~214.2A
M Range	0A~3.57A	0A~7.14A	0A~21.42A
L Range	0A~0.357A	0A~0.714A	0A~2.142A
Default Setting			
H Range	0A	0A	0A
M Range	0A	0A	0A
L Range	0A	0A	0A
Resolution			
H Range	1mA	2mA	10mA
M Range	0.1mA	0.2mA	1mA
L Range	0.01mA	0.02mA	0.1mA
Accuracy of Setting			
H, M Range	$\pm(0.2\% \text{ of set} + 0.1\% \text{ of f.s}^{*1}) + V_{in}^{*2}/500\text{k}\Omega$		
L Range	$\pm(0.2\% \text{ of set} + 0.1\% \text{ of f.s}) + V_{in}^{*2}/500\text{k}\Omega$		
Parallel Operation	$\pm(1.2\% \text{ of set} + 1.1\% \text{ of f.s}^{*3})$		
Input Voltage Variation^{*4}			
H Range	$2\text{mA} + V_{in}^{*2}/500\text{k}\Omega$	$4\text{mA} + V_{in}^{*2}/500\text{k}\Omega$	$10\text{mA} + V_{in}^{*2}/500\text{k}\Omega$
M Range	$2\text{mA} + V_{in}^{*2}/500\text{k}\Omega$	$4\text{mA} + V_{in}^{*2}/500\text{k}\Omega$	$10\text{mA} + V_{in}^{*2}/500\text{k}\Omega$
L Range	$0.1\text{mA} + V_{in}^{*2}/500\text{k}\Omega$	$0.2\text{mA} + V_{in}^{*2}/500\text{k}\Omega$	$0.6\text{mA} + V_{in}^{*2}/500\text{k}\Omega$
Ripple			
RMS ^{*5}	3mA	5mA	20mA ^{*7}
P-P ^{*6}	30mA	50mA	100mA ^{*7}

*1 Full scale of H range

*2 V_{in} : input terminal voltage of electronic load

*3 M range applies to the full scale of H range

*4 When the input voltage is varied from 1.5V to 150V at a current of rated power/150V

*5 Measurement frequency bandwidth: 10Hz to 1MHz

*6 Measurement frequency bandwidth: 10Hz to 20MHz

*7 At measurement current of 100A

CR Mode

Model	PEL-3021	PEL-3041	PEL-3111
Operating Range*¹			
H Range	23.3336S~400uS (42.857mΩ~2.5kΩ)	46.6672S~800uS (21.428mΩ~1.25kΩ)	140.0016S~2.4mS (7.1427mΩ ~416.6667Ω)
M Range	2.33336S~40uS (428.566mΩ~25kΩ)	4.6667S~80uS (214.28mΩ~12.5kΩ)	14.0001S~242.4uS (71.427mΩ~ 4.16667kΩ)
L Range	0.233336S~4uS (4.28566Ω~250kΩ)	0.46667S~8uS (2.1428Ω~125kΩ)	1.40001S~24.24uS (714.27mΩ ~41.6667kΩ)
Setting Range			
H Range	24.5S~0S (40.8163 mΩ~OPEN)	49.0S~0 S (20.408 mΩ~OPEN)	147.000S~0S (6.8027 mΩ~OPEN)
M Range	2.45S~0S (408.1633mΩ~ OPEN)	4.90S~0S (204.08mΩ~OPEN)	14.70000S~0S (68.0272mΩ~OPEN)
L Range	0.245S~0S (4.08163Ω~OPEN)	0.490S~0S (2.0408Ω~OPEN)	1.4000S~0S (680.2721mΩ~OPEN)
Resolution			
H Range	400uS	800uS	2.4mS
M Range	40uS	80uS	240uS
L Range	4uS	8uS	24uS
Accuracy of Setting*²			
H, M Range	$\pm(0.5 \% \text{ of set}^{*3} + 0.5 \% \text{ of f.s.}^{*4}) + \text{Vin}^{*5} / 500 \text{ k}\Omega$		
L Range	$\pm(0.5 \% \text{ of set}^{*3} + 0.5 \% \text{ of f.s.}) + \text{Vin}^{*5} / 500 \text{ k}\Omega$		

*1 Siemens[S] = Input current[A] / Input voltage[V] = 1 / resistance[Ω]

*2 Converted value at the input current. At the input current. It is not applied for the condition of the parallel operation.

*3 set = Vin / Rset

*4 f.s. = Full scale of High Range

*5 Vin = Input terminal voltage of electronic load

CV Mode

Model	PEL-3021	PEL-3041	PEL-3111
Operating Range			
H Range	1.5V~150V	1.5V~150V	1.5V~150V
M Range	1.5V~15V	1.5V~15V	1.5V~15V

Setting Range	
H Range	0V~157.5V
M Range	0V~15.75V
Resolution	
H Range	10mV
M Range	1mV
Accuracy of Setting*1	
H, L Range	$\pm(0.1\% \text{ of set} + 0.1\% \text{ of f.s})$
Input current variation*2	
H Range	50mV
L Range	12mV

*1 At the sensing point during remote sensing under the operating range of the input voltage. It is also applied for the condition of the parallel operation.

*2 With respect to a change in the current of 10 % to 100 % of the rating at an input voltage of 1.5 V (during remote sensing).

CP Mode

Model	PEL-3021	PEL-3041	PEL-3111
Operating Range			
H Range	17.5W ~175W	35W~350W	105W ~1050W
M Range	1.75W ~17.5W	3.5W~35W	10.5W ~105W
L Range	0.175W ~1.75W	0.35W~3.5W	1.05W ~10.5W
Setting Range			
H Range	0W~178.5W	0W~357W	0W~1071W
M Range	0W~17.85W	0W~35.7W	0W~107.1W
L Range	0W~1.785W	0W~3.57W	0W~10.71W
Resolution			
H Range	10mW	10mW	100mW
M Range	1mW	1mW	10mW
L Range	0.1mW	0.1mW	1mW
Accuracy of Setting*1			
$\pm(0.6\% \text{ of set} + 1.4\% \text{ of f.s}^{*2}) + V_{in}^{2*3}/500k\Omega$			

*1 It is not applied for the condition of the parallel operation.

*2 M range applies to the full scale of H range.

*3 V_{in} = Input terminal voltage of electric load.

Slew Rate

Model	PEL-3021	PEL-3041	PEL-3111
Setting Range (CC Mode)			
H Range	2.5mA/us~2.5A/us	5mA/us~5A/us	16.02mA/us~16.002A/us
M Range	250uA/us~250mA/us	500uA/us~500mA/us	1.602mA/us~1.6002A/us
L Range	25uA/us~25mA/us	50uA/us~50mA/us	160.2uA/us~160.02mA/us
Setting Range (CR Mode)			
H Range	250uA/us~250mA/us	500uA/us~500mA/us	1.602mA/us~1.6002A/us
M Range	25uA/us~25mA/us	50uA/us~50mA/us	160.2uA/us~160.02mA/us
L Range	2.5uA/us~2.5mA/us	5uA/us~5mA/us	16.02uA/us~16.002mA/us
Resolution			
Resolution	1mA	2mA	6mA
Setting	250mA/us~2.5A/us	500mA/us~5A/us	1.6A/us~16A/us
Resolution	100uA	200uA	600uA
Setting	25mA/us~250mA/us	50mA/us~500mA/us	160mA/us~1.6A/us
Resolution	10uA	20uA	60uA
Setting	2.5mA/us~25mA/us	5mA/us~50mA/us	16mA/us~160mA/us
Resolution	1uA	2uA	6uA
Setting	250uA/us~2.5mA/us	500uA/us~5mA/us	1.6mA/us~16mA/us
Resolution	100nA	200nA	600nA
Setting	25uA/us~250uA/us	50uA/us~500uA/us	160uA/us~1.6mA/us
Resolution	10nA	20nA	60nA
Setting	2.5uA/us~25uA/us	50uA/us~50uA/us	160uA/us~1.6mA/us
Accuracy of Setting^{*1}			
$\pm(10\% \text{ of set} + 5\text{us})$			

*1 Time to reach from 10 % to 90 % when the current is varied from 2 % to 100 % (20 % to 100 % in M range) of the rated current.

Meter

Model	PEL-3021	PEL-3041	PEL-3111
Voltmeter			
H Range	0.00V~150.00V	0.00V~150.00V	0.00V~150.00V

L Range	0.000V~15.000V	0.000V~15.000V	0.000V~15.000V
Accuracy	±(0.1 % of rdg + 0.1 % of f.s)		
Ammeter			
H Range	0.000A~35.000A	0.000A~70.000A	0.00A~210.00A
M Range	0.0000A~3.5000A	0.0000A~7.0000A	0.000A~21.000A
L Range	0.00mA~350.00mA	0.00mA~700.00mA	0.0mA~2100.0mA
Accuracy	±(0.2 % of rdg + 0.3 % of f.s*1)		
Accuracy	Parallel Operation: ±(1.2% of rdg +1.1% of f.s.)		
Wattmeter			
H, M Range	0.00W~175.00W	0.00W~350.00W	0.00W~1050W
L(CC/CR/CV mode)	0.000W~52.500W	0.000W~ 105.000W	0.00W~315.00W
L(CP mode)	0.0000W~ 1.7500W	0.0000W~ 3.5000W	0.000W~ 10.500W
Temperature Coefficient per °C			
Voltmeter	100ppm		
Ammeter	200ppm		

*1 M range applies to the full scale of H range.

Dynamic Mode

Model	PEL-3021	PEL-3041	PEL-3111
Operating Mode			
CC, CR and CP			
T1 & T2			
0.025ms ~ 10ms / Res: 1us 10ms ~ 30s / Res: 1ms			
Accuracy			
± 100ppm of setting			
Frequency Range (Freq./Duty)			
1Hz ~20kHz			
Frequency Resolution			
1Hz~9.9Hz		0.1Hz	
10Hz~99Hz		1Hz	
100Hz~990Hz		10Hz	
1kHz~20kHz		100Hz	
Frequency Accuracy of Setting			
(0.5% of set)			
Duty Cycle of Setting (Freq./Duty)			
1% ~99% , 0.1% step			
The minimum time width is 10 us. Between 1kHz and 20kHz, the maximum duty cycle is limited by the minimum time width.			
Slew Rate Setting Range (CC Mode)			

H Range	2.5mA/us~2.5A/us	5mA/us~5A/us	16mA/us~16A/us
M Range	250uA/us~250mA/us	500uA/us~500mA/us	1.6mA/us~1.6A/us
L Range	25uA/us~25mA/us	50uA/us~50mA/us	160uA/us~160mA/us
Slew Rate Setting Range (CR Mode)			
H Range	250uA/us~250mA/us	500uA/us~500mA/us	1.6mA/us~1.6A/us
M Range	25uA/us~25mA/us	50uA/us~50mA/us	160uA/us~160mA/us
L Range	2.5uA/us~2.5mA/us	5uA/us~5mA/us	16uA/us~16mA/us
Slew Rate Resolution			
Resolution	1mA	2mA	6mA
Setting	250mA/us~2.5A/us	500mA/us~5A/us	1.6A/us~16A/us
Resolution	100uA	200uA	600uA
Setting	25mA/us~250mA/us	50mA/us~500mA/us	160mA/us~1.6A/us
Resolution	10uA	20uA	60uA
Setting	2.5mA/us~25mA/us	5mA/us~50mA/us	16mA/us~160mA/us
Resolution	1uA	2uA	6uA
Setting	250uA/us~2.5mA/us	500uA/us~5mA/us	1.6mA/us~16mA/us
Resolution	100nA	200nA	600nA
Setting	25uA/us~250uA/us	50uA/us~500uA/us	160uA/us~1.6mA/us
Resolution	10nA	20nA	60nA
Setting	2.5uA/us~25uA/us	50uA/us~50uA/us	160uA/us~1.6mA/us
Slew Rate Accuracy of Setting^{*1}			
±(10% of set + 5us)			

*1 Time to reach from 10 % to 90 % when the current is varied from 2 % to 100 % (20 % to 100 % in M range) of the rated current.

Current Setting Range			
H Range	0A~35.7A	0A~71.4A	0A~214.2A
M Range	0A~3.57A	0A~7.14A	0A~21.42A
L Range	0A~0.357A	0A~0.714A	0A~2.142A
Current Resolution			
H Range	1mA	2mA	10mA
M Range	0.1mA	0.2mA	1mA
L Range	0.01mA	0.02mA	0.1mA
Current Accuracy			
±0.4% F.S			
Resistance Setting Range			
H Range	24.5S~0S (40.8163 mΩ~OPEN)	49.0S~0 S (20.408 mΩ~OPEN)	147.000S~0S (6.8027 mΩ~OPEN)
M Range	2.45S~0S (408.1633mΩ~ OPEN)	4.90S~0S (204.08mΩ~OPEN)	14.70000S~0S (68.0272mΩ~OPEN)
L Range	0.245S~0S (4.08163Ω~OPEN)	0.490S~0S (2.0408Ω~OPEN)	1.4000S~0S (680.2721mΩ~OPEN)

Resistance Resolution			
H Range	400uS	800uS	2.424mS
M Range	40uS	80uS	242.4uS
L Range	4uS	8uS	24.24uS
Resistance Accuracy of setting (R set(S) > 0.03% of f.s)			
H, M Range	$\pm(0.5 \% \text{ of set}^{*1} + 0.5 \% \text{ of f.s.}^{*2}) + \text{Vin}^{*3}/500 \text{ k}\Omega$		
L Range	$\pm(0.5 \% \text{ of set}^{*1} + 0.5 \% \text{ of f.s.}) + \text{Vin}^{*3}/500 \text{ k}\Omega$		
	*1 set = Vin / Rset		
	*2 f.s. = Full scale of High Range		
	*3 Vin = Input terminal voltage of Electronic Load		
Power Operating Range			
H Range	17.5W ~175W	35W~350W	105W ~1050W
M Range	1.75W ~17.5W	3.5W~35W	10.5W ~105W
L Range	0.175W ~1.75W	0.35W~3.5W	1.05W ~10.5W
Setting Range			
H Range	0W~178.5W	0W~357W	0W~1071W
M Range	0W~17.85W	0W~35.7W	0W~107.1W
L Range	0W~1.785W	0W~3.57W	0W~10.71W
Resolution			
H Range	10mW	10mW	100mW
M Range	1mW	1mW	10mW
L Range	0.1mW	0.1mW	1mW
Accuracy of Setting ^{*1}			
	$\pm(0.6 \% \text{ of set} + 1.4 \% \text{ of f.s.}^{*2}) + \text{Vin}^{*3}/500\text{k}\Omega$		

*1 It is not applied for the condition of the parallel operation.

*2 M range applies to the full scale of H range.

*3 Vin = Input terminal voltage of electronic load.

Soft Start

Operation Mode	
CC, CR and CP	
Selectable Time Range	
1~ 200 ms/Res: 1ms	
Time Accuracy	
$\pm(30\% \text{ of set} + 100\text{us})$	

Remote Sensing

Voltage that can be Compensated

2V for a single line

Protection Function

Model	PEL-3021	PEL-3041	PEL-3111
Overvoltage protection(OVP)	Turns off the load at 110% of the rated voltage		
Overcurrent protection(OCP)	0.03 ~ 38.5A	0.06A ~ 77A	0.2A ~ 231A
	or 110% of the maximum current of each range		
	Load off or limit selectable		
Overpower protection(OPP)	0.1W ~ 192.5W	0.3W ~ 385W	1W ~ 1155W
	or 110% of the maximum power of each range		
	Load off or limit selectable		
Overheat protection(OTP)	Turns off the load when the heat sink temperature reaches 95 °C		
Undervoltage protection(UVP)	Turns off the load when detected. Can be set in the range of 0 V to 150 V or Off.		
Reverse voltage protection(RVP)	By diode. Turns off the load when an alarm occurs.		
Rating overcurrent protection (ROCP)	An ROCP message will be produced when the input current range is greater than 110% of the rated operating current range (I range).		
Rating overpower protection (ROPP)	An ROPP message will be produced when the input power range is greater than 110% of the rated operating power range.		
Front panel input rating overcurrent protection (F.ROCP)	An F.ROCP message will be produced when the front panel input current range is greater than 77A (Typical).		

Sequence

Normal Sequence

Operation mode CC, CR, CV or CP

Maximum number of steps	1000
Step Execution Time	1ms – 999 h 59 min
Time resolution	1 ms (1 ms – 1 min)/100 ms (1 min – 1 h)/1 s (1 h – 10 h)/10 s (10 h – 100 h)/1 min (100 h – 999 h 59 min)
Fast Sequence	
Operation mode	CC or CR
Maximum number of steps	1000
Step Execution Time	25 μs – 600 ms
Time resolution	1us(25us -60ms) /10us(60.01ms -600ms)

Other

Elapsed Time Delay	
	Measures the time from load on to load off. On/Off selectable. Measures from 1 s up to 999 h 59 min 59 s
Auto Load Off Timer	
	Automatically turns off the load after a specified time elapses. Can be set in the range of 1 s to 999 h 59 min 59 s or off
Communication Function	
GPIB	IEEE std. 488.1-1978 (partial support) SH1, AH1, T6, L4, SR1, DC1, DT1. Supports the SCPI and IEEE std. 488.2-1992 command set Sets panel functions except the power switch and reads measured values
RS-232C	D-SUB 9-pin connector (conforms to EIA-232-D) Sets panel functions except the power switch and reads measured values Supports the SCPI and IEEE std. 488.2-1992 command set Baud rate: 2400, 4800, 9600, 19200, 38400 bps Data length: 8-bit, Stop bit: 1, 2-bit, Parity bit: None, Odd, Even.
USB	Conforms to USB 2.0 Specifications and USB-CDC ACM Sets panel functions except the power switch and reads measured values Communication speed 12 Mbps (Full speed)

Analog External Control

Load on/off Control Input

Turn on the load with low (or high) TTL level signal

Load on Status Output

On when the load is on (open collector output by a photocoupler)

Range Switch Input

Switch ranges L, M, and H using a 2-bit signal

Range Status Output

Outputs range L, M, or H using 2-bit signal (open collector output by a photocoupler)

Trigger Input

Clear the sequence operation pause with a high TTL level signal for 10 μ s or more.

Alarm Input

Activate alarm with low TTL level signal input

Alarm Status Output

On when OVP, OCP, OPP, OTP, UVP, RVP, or when an external alarm input is applied (open collector output by a photocoupler)

Short Signal Output

Relay contact output (30 VDC/1 A)

External Voltage Control

Operates in CC, CR, CP, or CV mode

0 V to 10 V correspond to 0 % to 100 % of the rated current (CC mode), rated voltage (CV mode), or rated power (CP mode).

0 V to 10 V correspond to maximum resistance to minimum resistance (CR mode)

External Resistance Control

Operates in CC, CR, CP, or CV mode

0 Ω to 10 k Ω correspond to 0 % to 100 % or 100 % to 0 % of the rated current (CC mode), rated voltage (CV mode), or rated power (CP mode).

0 Ω to 10 k Ω correspond to maximum resistance to minimum resistance or minimum resistance to maximum resistance (CR mode)

Current Monitor Output

10 V f.s (H or L range) and 1 V f.s (M range)

Parallel Operation Input

Signal input for one-control parallel operation

Parallel Operation Output

Signal input for one-control parallel operation

Load Boost Power Supply Control

Power on/off control signal for the load booster

Front Panel BNC Connector

TRIG OUT

Trigger output: Approx. 5V pulse width: Approx. 2 μ s, output impedance: Approx. 500 Ω

Outputs a pulse during sequence operation and switching operation.

I MON OUT

Current monitor output

1 V f.s (H or L range) and 0.1 V f.s (M range)

General

Model	PEL-3021	PEL-3041	PEL-3111	PEL-3211
-------	----------	----------	----------	----------

Inrush Current

45A Max

Insulation Resistance

Primary to input terminal: 500 VDC, 20M Ω or more.Primary to chassis: 500 VDC, 20M Ω or more.

Withstand Voltage

Primary to input terminal: No abnormalities at 1500 VAC for 1 minute.

Primary to chassis: No abnormalities at 1500 VAC for 1 minute.

Dimensions(mm)

213.8(W)	213.8(W)	427.8(W)	427.7(W)
x124(H)	x124(H)	x124(H)	x127.8(H)
x400.5(D)	x400.5(D)	x400.5(D)	x553.5(D)

Weight

Approx. 6kg	Approx. 7kg	Approx. 17kg	Approx. 23kg
-------------	-------------	--------------	--------------

PEL-3000 Dimensions

PEL-3111

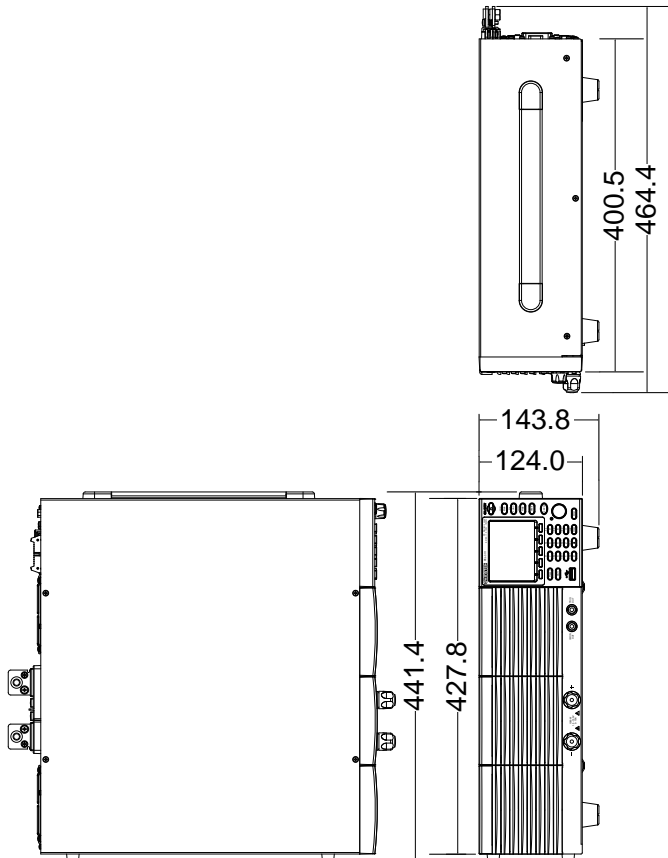

PEL-3021, PEL-3041

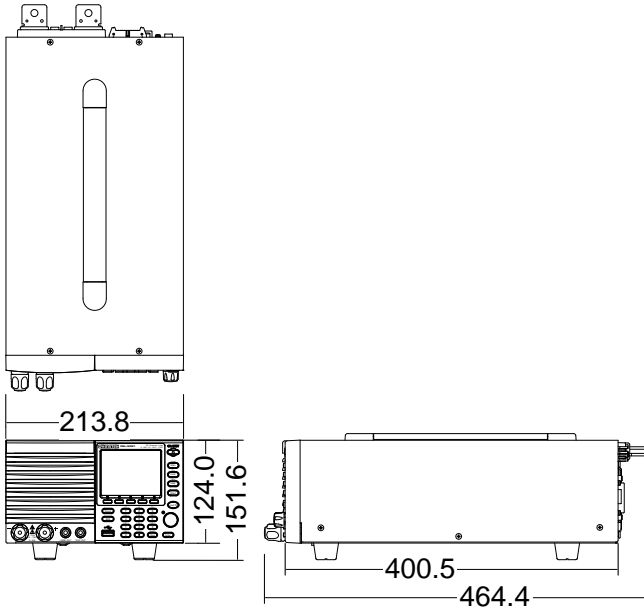

PEL-3211

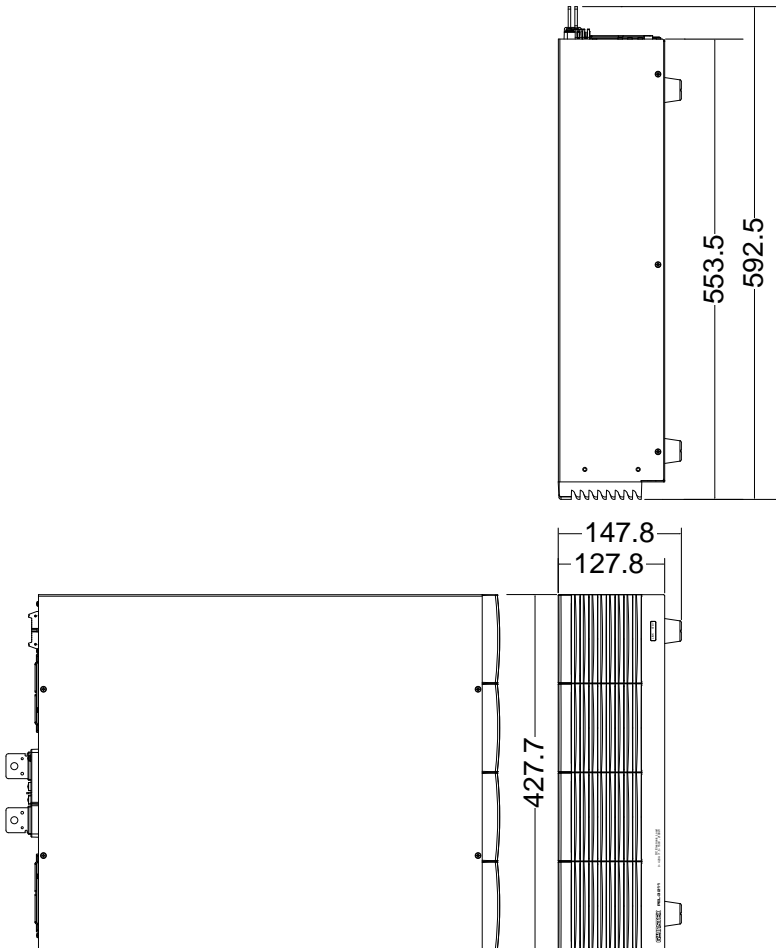

Declaration of Conformity

We

GOOD WILL INSTRUMENT CO., LTD.

No. 7-1, Jhongsing Rd, Tucheng Dist., New Taipei City 236, Taiwan

GOOD WILL INSTRUMENT (SUZHOU) CO., LTD.

No. 69 Lushan Road, Suzhou New District Jiangsu, China.

declare that the below mentioned product

Type of Product: DC Electronic Load

Model Number: PEL-3021, PEL-3041, PEL-3111, PEL-3211

is herewith confirmed to comply with the requirements set out in the Council Directive on the Approximation of the Laws of the Member States relating to the Low Voltage Directive (2006/95/EC) and Electromagnetic Compatibility (2004/108/EC).

For the evaluation regarding the Electromagnetic Compatibility and Low Voltage Directive, the following standards were applied:

© EMC

EN 61326-1 :	Electrical equipment for measurement, control and laboratory use -- EMC requirements (2006)
EN 61326-2-1:	
EN 61326-2-2:	
Conducted and Radiated Emissions EN 55011: 2009+A1: 2010	Electrostatic Discharge EN 61000-4-2: 2009
Current Harmonic EN 61000-3-2: 2006+A1: 2009+A2: 2009	Radiated Immunity EN 61000-4-3: 2006+A1: 2008+A2 :2010
Voltage Fluctuation EN 61000-3-3: 2008	Electrical Fast Transients EN 61000-4-4: 2004+A1: 2010
-----	Surge Immunity EN 61000-4-5: 2006
-----	Conducted Susceptibility EN 61000-4-6: 2009
-----	Power Frequency Magnetic Field EN 61000-4-8: 2010
-----	Voltage Dips/ Interrupts EN 61000-4-11: 2004

Low Voltage Equipment Directive 2006/95/EC	
Safety Requirements	EN 61010-1: 2010 EN 61010-2-030: 2010

INDEX

Accessories	12	Disposal instructions	6
Advanced configuration		Disposal symbol	3
Alarm tone	90	Dynamic mode frequency	69
Auto Load	77	EN61010	
Control settings	91	Measurement category	4
Count time	75	Pollution degree	6
Cut off time	76	Environment	
Display	90	Safety instruction	5
Dyna. Time	69	External control	
Go-NoGo	92	Alarm	151
Language	91	Alarm status	152
Load Off (Mode)	78	Current monitor	153
Load Off (Range)	78	Current range	148
OCP	83	Current status	149
OPP	84	Load status	148
OVP	86	Overview	137
Protection settings	83	Resistance control	141
Short(safety)	79	Short control	152
Soft start	72	Trigger	150
Speaker	89	Trigger signal output	153
Step resolution	80	Turning the load on	146
System settings	89	Voltage control	138
UVP	85	External control	136
Von delay	75	FAQ	174
Von latch	74	Fast Sequence	
Von voltage	73	Configuration	117
Alarm Tone	90	Data edit	118
Analog connector		Overview	113
pin assignment	137	Run	120
Caution symbol	3	File Utility	132
CC Response speed	71	Firmware update	41
Cleaning the instrument	5	First time use instructions	24
Conventions	43	Front panel diagram	15
CP Response speed	71	Go_NoGo Tone	90
CR Response speed	71	GPIB installation	180
CV Response rate	70	Ground	
Declaration of conformity	213	Symbol	3
Default settings	181	Help	49
operation	134	Input terminals	
User	135	Front	33
Display diagram	23	Rear	34

Terminal cover.....	35	Short key configuration.....	63
PEL-013.....	38	Slew rate.....	69
Knob configuration		Staticmode.....	65
Cursor.....	80	Turning the load on.....	61
Step.....	81	OPP alarm.....	84
Load default settings.....	28	OVP alarm.....	86
Load wiring.....	31	Package contents.....	14
Connection.....	32	Parallel operation	
Main features.....	11	Capacity.....	155
Marketing		Capacity with boosters.....	156
Contact.....	175	Configuration.....	158
Memory Recall		Connection.....	156
safety setting.....	131	Disable.....	161
Monitor signal output.....	153	Overview.....	155
Normal Sequence		Turning the load on.....	160
Configuration.....	107	Power supply	
Data edit.....	109	Safety instruction.....	5
Overview.....	103	Power up.....	27
Run.....	111	Preset.....	134
OCP alarm.....	83	Presets	
Operating area		Save/Recall.....	133
PEL-3021.....	194	Program	
PEL-3041.....	195	Chain.....	100
PEL-3111.....	196	Configuration.....	97
PEL-3211.....	197	Overview.....	95
Operating mode		Run.....	101
CC.....	189	Rack mount installation.....	24
CC+CV.....	189	Rear panel diagram.....	20
CP.....	191	Remote control.....	162
CP+CV.....	192	GPIB configuration.....	163
CR.....	190	RS232C configuration.....	165
CR+CV.....	191	USB configuration.....	163
CV.....	193	Remote control function check166	
Operation.....	53	GPIB.....	171
+CV mode.....	60	Realterm.....	167
CC mode.....	53	Remote sense.....	40
CC Response speed.....	71	Replace the clock battery.....	179
CP mode.....	58	Replace the dust filter.....	178
CP Response speed.....	71	Restore default settings.....	134
CR mode.....	55	Safety short.....	79
CR Response speed.....	71	Save/Recall.....	122
CR units.....	57	File types.....	123
CV mode.....	57	Presets.....	133
CV Response rate.....	70	Recall from memory.....	128
Dynamic mode.....	65	Recall from USB.....	129
Dynamic mode units.....	67	Recall Safety.....	131
panel lock.....	63	Save to internal memory.....	124
Short key.....	62		

Save to USB.....	126	PEL-3211	198
Sequence	103	UK power cord.....	7
Service operation		UnReg alarm	87, 88
About disassembly	4	Unreg Tone	90
Contact	175	UVP alarm	85
Setting the date and time.....	28	Warning symbol	3
Specifications		Wire gauge	29
Dimensions.....	210	Theory	30
Frequency	198		