

BENCHTOP INSTRUMENT



**Programmable
DC Power Supply
Operation Manual V1.0**

CE

CONTENTS

SAFETY INSTRUCTION	III
1. PRODUCT INTRODUCTION	- 1 -
1-1. Description	- 1 -
1-2. Features	- 1 -
1-3. Front and Rear Panels	- 2 -
1-4. Key Description	- 3 -
1-5. LCD display	- 4 -
1-6. First Use	- 5 -
1-7. Display Modes	- 6 -
2. OPERATION INTRODUCTION	- 7 -
2-1. How to input	- 7 -
2-2. Constant Voltage Output	- 8 -
2-3. Constant Current Output	- 9 -
2-4. Over Voltage/Over Current Protection	- 10 -
2-5. Timing Output	- 11 -
2-6. Save/Recall	- 14 -
2-7. Utility	- 16 -
2-8. Auxiliary Function	- 20 -
2-9. Remote Sensing Function	- 22 -
2-10. Analog Control Function	- 23 -
3. REMOTE CONTROL	- 24 -
3-1. Interface Setting	- 24 -
3-2. SCPI Commands	- 24 -
4. MAINTENANCE	- 25 -
4-1. Inspection	- 25 -
4-2. Fuse Replacement	- 25 -
5. SPECIFICATIONS	- 26 -

Use of Operation Manual

Please read through and understand this Operation Manual before operating the product. After reading, always keep the manual nearby so that you may refer to it as needed. When moving the product to another location, be sure to bring the manual as well.

Calibration Notification

We notify that the instruments included in this manual are in compliance with the features and specifications as stated in this manual. Before shipment, the instrument has been calibrated in factory. The calibration procedures and standards are compliant to the national regulations and standards for electronic calibration.

Warranty

We guarantee that the instrument has been passed strict quality check. We warrant our instrument's mainframe and accessories in materials within the warranty period of one year. We guarantee the free spare parts for products which are approved defective in this period. To get repair service, please contact with your nearest sales and service office. We do not provide any other warranty items except the one being provided by this summary and the warranty statement. The warranty items include but not being subjected to the hinted guarantee items related to tradable characteristics and any particular purpose. We will not take any responsibility in cases regarding to indirect, particular and ensuing damage, such as modifications to the circuit and functions by the users, repairing or component replacement by the users, or damage during transportation.

For product improvement, the specifications are subject to change without prior notice.

Format Conventions in this Manual

1) Key

The function key at the front panel is denoted by the format of "Key Name (Bold) + Text Box" in the manual. For example, **Utility** denotes the "Utility" key.

2) Menu

The menu item is denoted by the format of "Menu Word (Bold) + Character Shading". For example, **System** denotes the "System" item under Utility.

3) Operation Step

The next step of the operation is denoted by an arrow "→" in the manual. For example, **Utility**→**System** denotes pressing **Utility** at the front panel and then pressing **System**.

SAFETY INSTRUCTION

This chapter contains important safety instructions that you must follow when operating the instrument and when keeping it in storage. Read the following before any operation to insure your safety and to keep the best condition for the instrument.

Safety Symbols

The following safety symbols may appear in this manual or on the instrument:



WARNING

Identifies conditions or practices that could result in injury or loss of life.



CAUTION

Identifies conditions or practices that could result in damage to the instrument or to other properties.



DANGER

High voltage



ATTENTION

Refer to the manual



Protective conductor terminal



Earth (ground) terminal



Chassis ground terminal

Safety Guidelines



- Before plugging into local AC mains, check and make sure that the output voltage is compatible to the load. (It is suggested to disconnect a load before plugging into local AC mains.)
- Do not use this instrument near water.
- Do not operate or touch this instrument with wet hands.
- Do not open the casing of the instrument when it is connected to AC mains.
- The max. output voltage of the instrument may be over 60VDC, avoid touch the metal contact part of the output terminals.
- Do not use the instrument in an atmosphere which contains sulfuric acid mist or other substances which cause corrosion to metal.
- Do not use the instrument in a dusty place or a highly humid place as such will cause instrument reliability degradation and instrument failures.
- Install the instrument in a place where is free from vibration.
- Install the instrument in a place where the ambient temperature is in range of -10~70°C. Note that the instrument operation may become unstable if it is operated in an ambient temperature exceeding the range of 0~40°C

Power supply

AC Input voltage: 110V/220V±10%, 50/60Hz



Connect the protective grounding conductor of the AC power cord to an earth ground to avoid electrical shock.

Fuse	<ul style="list-style-type: none"> ● Fuse type: please refer to section 5.2 for details. ● Make sure the correct type of fuse is installed before power up. ● Replace the AC fuse with the same type and rating as the original fuse. ● Disconnect the power cord before fuse replacement. ● Make sure the cause of fuse blowout is fixed before fuse replacement.
Cleaning	<ul style="list-style-type: none"> ● Disconnect the power cord before cleaning. ● Use a soft cloth dampened in a solution of mild detergent and water. Do not spray any liquid. ● Do not use chemicals or cleaner containing harsh material such as benzene, toluene, xylene, and acetone.
Operation environment	<ul style="list-style-type: none"> ● Location: indoor, no direct sunlight, dust free, almost non-conductive pollution (note below). ● Relative humidity: <80% ● Altitude: <2000m ● Temperature: 0°C ~ 40°C <p data-bbox="461 824 1445 898">(Pollution Degree) EN 61010-1:2001 specifies the pollution degrees and their requirements as follows. The instrument falls under degree 2.</p> <p data-bbox="461 909 1445 983">Pollution refers to “addition of foreign matter, solid, liquid, or gaseous (ionized gases), that may produce a reduction of dielectric strength or surface resistivity”.</p> <p data-bbox="461 994 1445 1068">Pollution degree 1: No pollution or only dry, non-conductive pollution occurs. The pollution has no influence.</p> <p data-bbox="461 1079 1445 1189">Pollution degree 2: Normally only non-conductive pollution occurs. Occasionally, however, a temporary conductivity caused by condensation must be expected.</p> <p data-bbox="461 1200 1445 1435">Pollution degree 3: Conductive pollution occurs, or dry, nonconductive pollution occurs which becomes conductive due to condensation which is expected. In such conditions, equipment is normally protected against exposure to direct sunlight, precipitation, and full wind pressure, but neither temperature nor humidity is controlled.</p>
Storage environment	<ul style="list-style-type: none"> ● Location: indoor ● Relative humidity: <70% ● Temperature: -10°C ~ 70°C

Power cord for the United Kingdom

When using the power supply series in the United Kingdom, make sure the power cord meets the following safety instructions.

NOTE: This lead/appliance must only be wired by competent persons.



WARNING: THIS APPLIANCE MUST BE EARTHED.

IMPORTANT: The wires in this lead are coloured in accordance with the following code:

Green/Yellow:	Earth
Blue:	Neutral
Brown:	Live



As the colours of the wires in main leads may not correspond with the colours marking identified in your plug/appliance, proceed as follows:

- The wire which is coloured Green & Yellow must be connected to the Earth terminal marked with the letter E or by the earth symbol \oplus or coloured Green or Green & Yellow.
- The wire which is coloured Blue must be connected to the terminal marked with the letter N or coloured Blue or Black.
- The wire which is coloured Brown must be connected to the terminal marked with the letter L or P or coloured Brown or Red.

If in doubt, consult the instructions provided with the equipment or contact the supplier.

This cable/appliance should be protected by a suitably rated and approved HBC mains fuse: refer to the rating information on the equipment and/or user instructions for details. As a guide, cable of 0.75mm^2 should be protected by a 3A or 5A fuse. Larger conductors would normally require 13A types, depending on the connection method used.

Any moulded mains connector that requires removal/replacement must be destroyed by removal of any fuse & fuse carrier and disposed of immediately, as a plug with bared wires is hazardous if engaged in live socket. Any re-wiring must be carried out in accordance with information detailed on this label.

1. PRODUCT INTRODUCTION

1-1. Description

PPS series are high accuracy programmable DC power supply with single output. MPU control, RS232/RS485/USB interface for PC control, the PPS series facilitates auto test and auto control. The commands of the PPS series are compliant with SCPI commands. Users can easily develop programs to facilitate different applications in auto test and auto control. Users can also store or recall data via the USB host on front panel.

The 4.3-inch TFT LCD display gives full display for parameters and output waveforms. Digital input fulfilled by rotary dial and keypad input makes input fast and accurate. Voltage and current regulations by software, avoids human error and makes the PPS series more accurate.

1-2. Features

- High accuracy, high resolution 1mV/1mA
- 4.3 inches TFT LCD display
- Over load, over voltage, over current, over temperature and reverse polarity protections
- CV and CC operations, auto CV and CC switch
- High speed rotary dial and keypad input
- Built-in beeper alarm
- Panel lock and output ON/OFF function
- 100 sets save & recall for voltage, current and time setups, easy use in auto test
- Timing output function and support infinite and specified number of cycles of output
- Low resistance measurement function, display load resistance value
- Remote sense function
- Smart cooling fan achieving low noise
- Battery charge mode
- Standard USB host interface for data storage and recall from external USB flash driver
- Standard RS232 interface, support SCPI commands, support Labview
- Standard 0-5V analog control
- Optional RS485 interface, support Modbus
- Optional RS232 to USB cable

1-3. Front and Rear Panels

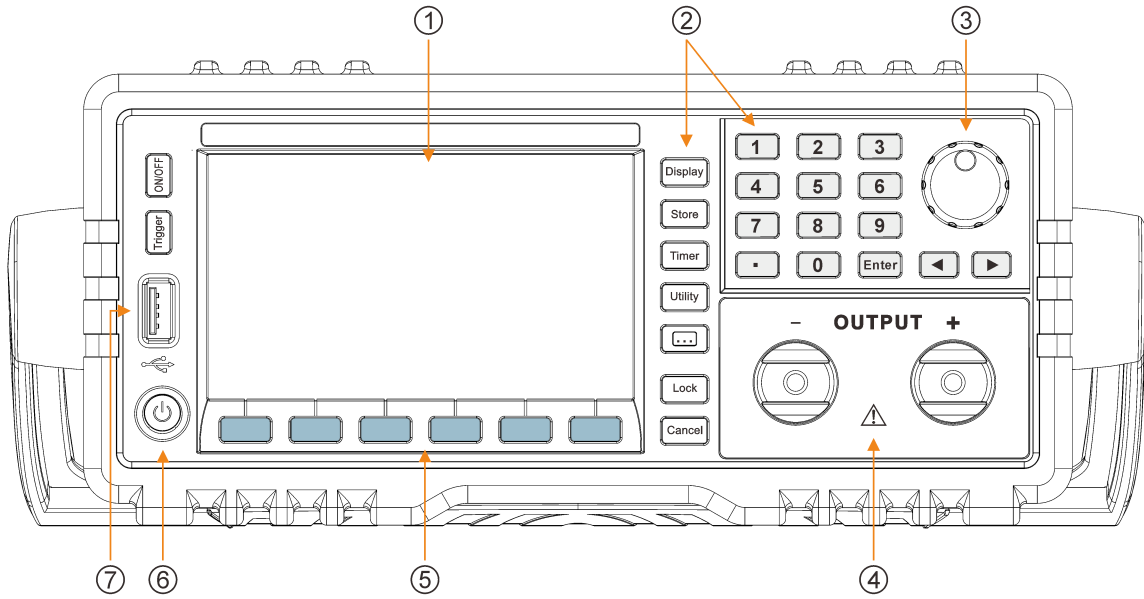

Fig.1.3-1 Front Panel

- | | | |
|---------------------|---------------------|---------------------|
| 1. LCD display | 2. Function buttons | 3. Parameters input |
| 4. Output terminals | 5. Menu keys | 6. Power switch |
| 7. USB Host port | | |

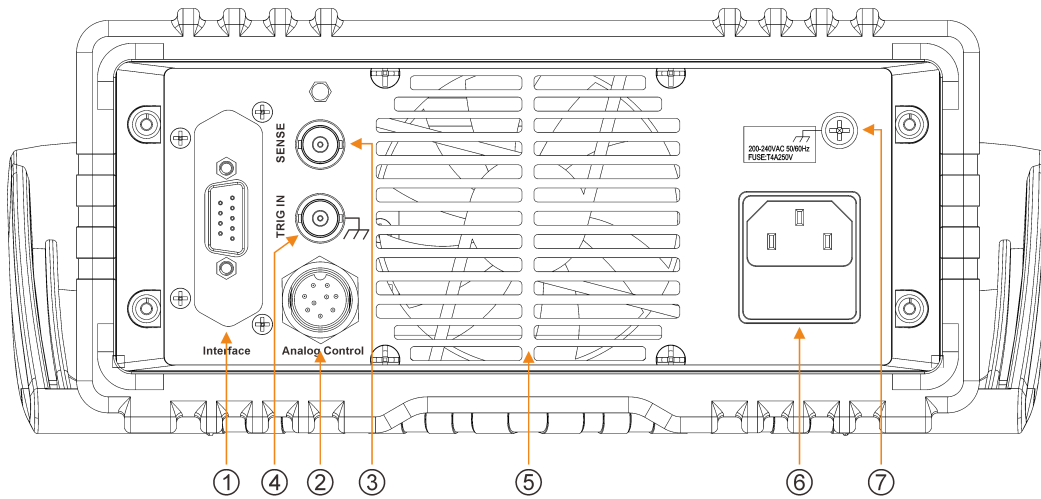

Fig.1.3-2 Rear panel

- | | | |
|-------------------------------|-----------------------------|-----------------------------|
| 1. RS232 interface | 2. Analog control interface | 3. Remote sensing terminal |
| 4. Trigger input | 5. Cooling fan | 6. Power cord / fuse socket |
| 7. Ground terminal of chassis | | |

1-4. Key Description

There are 30 buttons on the front panel (not including POWER button). Press the button directly to use the basic function.

Key name	Main function
0	Input digit 0
1	Input digit 1
2	Input digit 2
3	Input digit 3
4	Input digit 4
5	Input digit 5
6	Input digit 6
7	Input digit 7
8	Input digit 8
9	Input digit 9
.	Input decimal point
◀ ▶	Move flash digit to the left/right
Rotary knob	Adjust setting value
Enter	Confirm input
Display	Switch display modes between parameter and waveform
Store	Store and recall the settings of instrument
Timer	Enable timing output
Utility	Set up system configuration
⋮	Set up auxiliary function
Lock	1. Lock the front panel 2. Switch to local operation
Cancel	Cancel key
Menu keys	With different functions in different menus Including voltage and current setting, O.V.P and O.C.P setting
On/Off	Turn on/off output
Trigger	Trigger key
USB Host port	Enable data storage and recall from USB flash driver

1-5. LCD display

This instrument provides two display modes: normal display mode and waveform display mode. Please refer to section 1-7 for details.

①	ON CV	UDISK			
	05.000 V	Set	05.000 V	④	
			01.000 A	⑤	
②	00.000 A	O.V.P	OFF	⑥	
			05.2 V	⑦	
	00.000 W	O.C.P	OFF	⑧	
			01.2 A	⑨	
③	Voltage	Current	O.V.P OFF On	O.C.P OFF On	
1	Status bar	ON/OFF	: Output on/off status.		
		CV/CC	: Constant Voltage/Constant Current mode.		
		O.V.P/O.C.P	: Over-voltage protection or over-current protection is enabled. Output will be turned off automatically.		
		O.T.P	: Over-temperature protection is enabled. Output will be turned off automatically.		
		LOCK	: The front panel is locked.		
		UDISK	: A USB storage device is detected.		
		ERR	: Remote operation error.		
		RMT	: The instrument is in remote operation mode.		
		SENSE	: Remote sense function is enabled.		
		A CTRL	: Analog control function is enabled.		
2	Real time output values				
3	Operation menus				
4	Voltage setting value				
5	Current setting value				
6	O.V.P on/off status				
7	O.V.P setting value				
8	O.C.P on/off status				
9	O.C.P setting value				

1-6. First Use

1-6-1. Connect to Power

- 1) Check the input power
Make sure that the AC power to be connected to the instrument fulfills the requirements in chapter 5.
- 2) Check the fuse
When the instrument leaves factory, the specified fuse is installed. Make sure the correct type of fuse is installed before power up. Please see section 4.2 for details.
- 3) Connect the AC power
Connect the instrument to AC power supply using the power cord provided in the accessories.



To avoid electric shock, make sure that the instrument is correctly grounded.

1-6-2. Power-on Inspection

Press the power switch at the front panel, the instrument starts and executes self-test. If the instrument passes the self-test, the welcome interface will be displayed; otherwise, the corresponding self-test failure information (including the top board, bottom board, fan and temperature) will be displayed.

Note:

When powering on the instrument after powering off it, make sure that the time interval between the two operations is longer than 5s.

1-6-3. Output Inspection

In virtue of this function, the instrument enables to respond to front panel correctly and output rated value. The inspections are mainly centered on the voltage output on the occasion of no loads for the channel and the current output when short circuit.

- 1) Output switch

Press **ON/OFF** button to turn on/off the output. The button's backlight will turn on once the instrument is powered on.

- 2) Voltage output inspection

- a. When the instrument has no load: Press power switch and make sure that the setting value of current is not 0.
- b. Press **ON/OFF** button, the channel will be in constant voltage output state after **ON/OFF** button light goes on, then check whether the voltage can be adjusted from 0 to the maximum rated value.

- 3) Current output inspection

- a. Press **ON/OFF** button to turn on the output.
- b. Short the output terminal (+) and (-) at the front panel using an insulating output lead.
- c. Set the voltage to the maximum rated value.
- d. After **ON/OFF** button light goes on, check whether the current can be adjusted from 0 to the maximum rated value.

1-7. Display Modes

This instrument provides two display modes: normal display mode and waveform display mode. Users can select the appropriate display mode as needed.

1-7-1. Normal display mode

After power on, the instrument enters normal display mode as shown in the figure below. When the waveform display mode is enabled, it can be switched to normal display mode by pressing **Display** button, and at this point, the **Display** light is turned off. In normal display mode, the settings of voltage, current and power are displayed by digital form. The O.V.P and O.C.P also can be set.

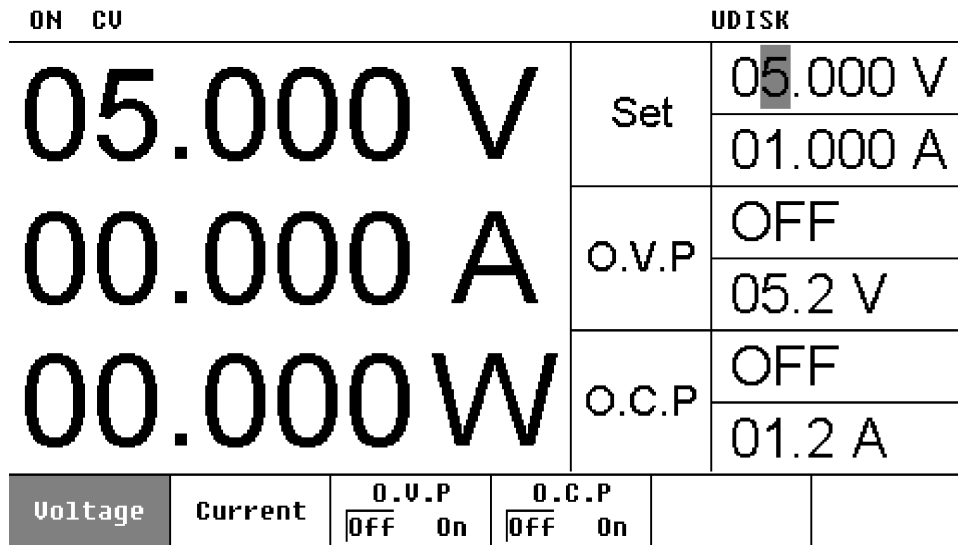

1-7-2. Waveform display mode

Press **Display** button to enter waveform display mode from normal display mode, at this point, the **Display** light is turned on. To exit, press the button again. In this mode, the settings of voltage, current and power are displayed by digital form and waveform form. The O.V.P and O.C.P also can be set.

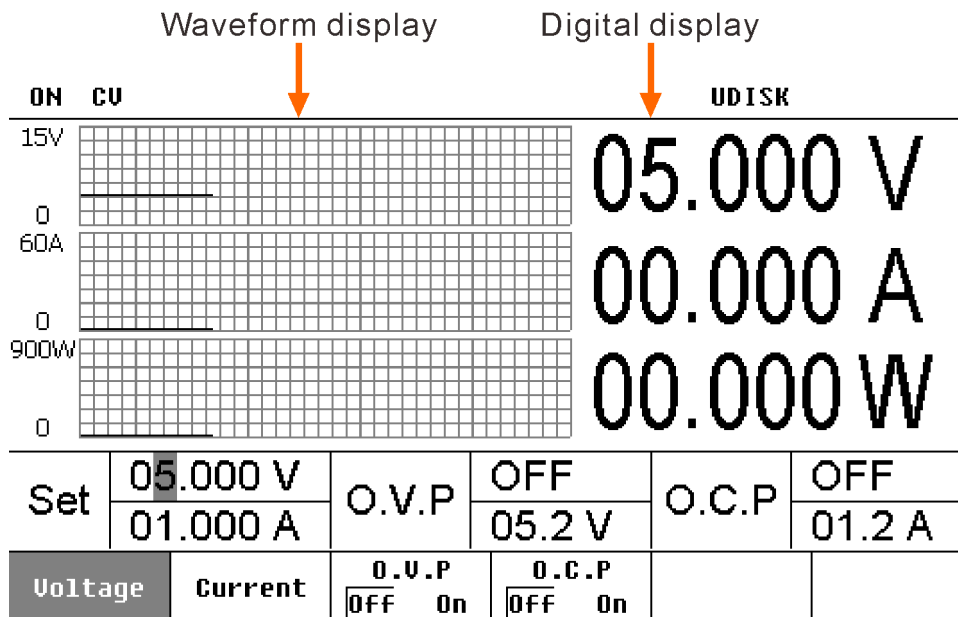

2. OPERATION INTRODUCTION

2-1. How to input

The instrument has two methods to input parameters: **direct data input** and **direct parameter input (modify)**. Parameters can be inputted by the numeric keyboard, cancel key, direction key and knob.

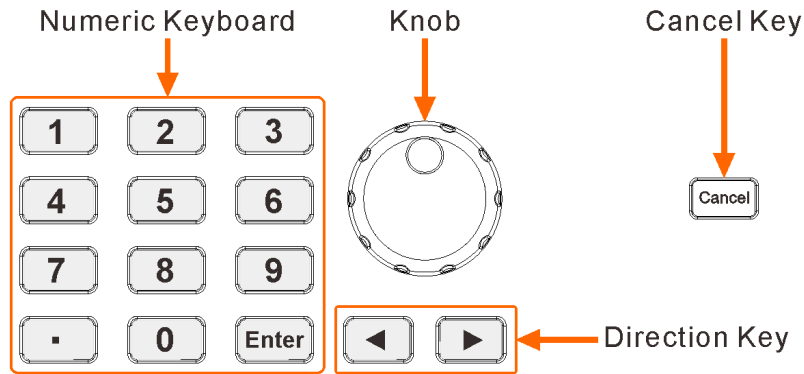

1) **Direct data input:** this method that applies to the following settings uses the numeric keyboard, cancel key and direction key to complete the input.

a. Voltage and current settings

- Press **Voltage** or **Current** softkey at the front panel to select the corresponding menu. The selected menu is in anti-color.
- Use the numeral key to input the numerical value, and press **Enter** button to confirm. The default Voltage/Current Unit is Volt (V) and Amp (A).

Note:

In the input process, users can delete the value bit by bit with the left direction key◀, also can cancel the whole input by pressing **Cancel** button.

b. O.V.P and O.C.P settings

Select **O.V.P** or **O.C.P** menu, the operation procedures are same as the settings for voltage and current.

c. Timing setting

Select **Timer Setup** menu, the operation procedures are same as the settings for voltage and current.

2) **Direct parameter input (modify):** this method uses the knob and direction key to complete the input.

a. This method applies to the above settings which can be completed with direct data input. For example: to set voltage and current.

- Press **Voltage** or **Current** softkey at the front panel to select the corresponding menu. The cursor location is in **Voltage** or **Current** input box.
- Rotate the knob to increase or decrease the cursor-located digit directly, press the left/right direction key to move the cursor left or right, so the digits in other locations can be changed.

b. Store / recall location selection

- Press **Store** button at the front panel to enter the corresponding interface.
- Rotate the knob to select the desired store / recall location.

2-2. Constant Voltage Output

This instrument provides two kinds of output mode including Constant Voltage Output (CV) and Constant Current Output (CC), which depends on the specified voltage and current as well as the loads carried by the instrument. The instrument will not output voltage or current beyond setting value. In CV mode, the output voltage equals to the specified value and the output current equals to the specified value in CC mode.

For example: set the voltage to 16V, the current to 3A and the load to 8Ω/300W separately. Because $8\Omega \times 3A = 24V > 16V$ and $16V/8\Omega = 2A < 3A$, so the Constant Voltage Output of the channel is 16V, 2A.

Operation steps:

- 1) Connect the output lead: Connect the output terminal with the load as the following figure:

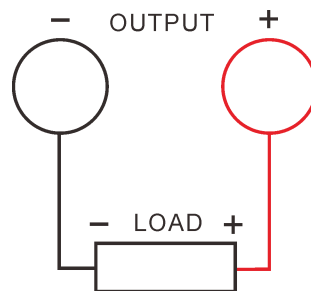

Please refer to the following table to select the output lead which should be shorter.

AWG*	10	12	14	16	18	20	22	24	26	28
Maximum current (A)	40	25	20	13	10	7	5	3.5	2.5	1.7
Milliohm/meter	3.3	5.2	8.3	13.2	21.0	33.5	52.8	84.3	133.9	212.9

Note*: AWG: American Wire Gauge



CAUTION

Wrong connection may lead damages to the instrument or the equipment connected to.

- 2) Turn on the power switch: Press the power switch to start the instrument.
- 3) Set the voltage: Press **Voltage** softkey to set the voltage to 16V.
- 4) Set the current: Press **Current** softkey to set the current to 3A.
- 5) Turn on the output: Press **ON/OFF** button, the button light turns on, the instrument will operate in CV mode.

Note:

In CV output mode, when the output current is greater than the current setting value because of load change, the power supply will switch to CC output mode in terms of the current setting value automatically, and the output voltage reduces proportionally. At this point, to resume CV output mode, increase the current setting value.

2-3. Constant Current Output

For example: set the voltage to 16V, the current to 5A and the load to $2\Omega/300W$ separately. Because $2\Omega \times 5A = 10V < 16V$ and $16V/2\Omega = 8A > 5A$, so the Constant Current Output of the channel is 10V, 5A.

Operation steps:

- 1) Connect the output lead: Connect the output terminal with the load as the following figure:

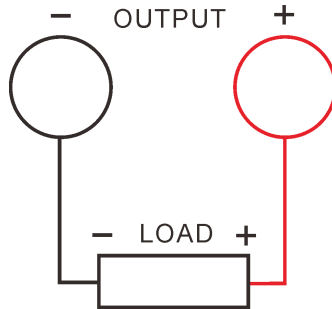

Wrong connection may lead damages to the instrument or the equipment connected to.

- 2) Turn on the power switch: Press the power switch to start the instrument.
- 3) Set the voltage: Press **Voltage** softkey to set the voltage to 16V.
- 4) Set the current: Press **Current** softkey to set the current to 5A.
- 5) Turn on the output: Press **ON/OFF** button, the button light turns on, the instrument will operate in CC mode.

Note:

In CC output mode, when the output voltage is greater than the voltage setting value because of load change, the power supply will switch to CV output mode in terms of the voltage setting value automatically, and the output current reduces proportionally. At this point, to resume CC output mode, increase the voltage setting value.

2-4. Over Voltage/Over Current Protection

This instrument provides Over Voltage Protection (O.V.P) and Over Current Protection (O.C.P) functions to protect the load from the damage caused by the output over the load rated value. Users can set the O.V.P and O.C.P parameters and enable/disable these functions as needed. If the O.V.P/O.C.P is enabled, the instrument will turn off the output to protect the load when the output is over than the O.V.P/ O.C.P setting value.

2-4-1. O.V.P

O.V.P setting includes parameter setting and enabling/disabling the over voltage protection. The detailed steps are shown as below:

- 1) Parameter setting
 - Select **O.V.P** menu;
 - Use the numeral key to input the numerical value, and press **Enter** button to confirm. Different modes maybe have different setting range.
 - After the parameter setting is finished, view the change of the O.V.P input box.
- 2) To enable/disable O.V.P
 - Press **ON/OFF** button to start the output;
 - Select **O.V.P** menu;
 - Switch the O.V.P status between “ON” and “OFF” by repeatedly pressing **O.V.P** to enable/disable the O.V.P.

Note:

With the output OFF, the O.V.P output will be turned off. But the O.V.P parameters still can be set. When the output voltage exceeds the O.V.P value, the output will be shut down automatically. The O.V.P default status is OFF and the default value is 5.2V, please set the O.V.P value as required.

2-4-2. O.C.P

O.C.P setting includes parameter setting and enabling/disabling the over current protection. The detailed steps are shown as below:

- 1) Parameter setting
 - Select **O.C.P** menu;
 - Use the numeral key to input the numerical value, and press **Enter** button to confirm. Different modes maybe have different setting range.
 - After the parameter setting is finished, view the change of the O.C.P input box.
- 2) To enable/disable O.C.P
 - Press **ON/OFF** button to start the output;
 - Select **O.C.P** menu;
 - Switch the O.C.P status between “ON” and “OFF” by repeatedly pressing **O.C.P** to enable/disable the O.C.P.

Note:

With the output OFF, the O.C.P output will be turned off. But the O.C.P parameters still can be set. When the output current exceeds the O.C.P value, the output will be shut down automatically. The O.C.P default status is OFF and the default value is 1.2A, please set the O.C.P value as required.

2-5. Timing Output

This instrument provides the function of timing output. When the timing output is enabled, the instrument outputs the preset voltage and current values (at most 100 groups) to truly simulate the various kinds of running status of power supply.

Operation steps:

- 1) Press **Timer** button at the front panel and press **Timer On/Off** softkey to select "On", and then start the timing output function.
- 2) Turn on the output, the instrument starts to output.

As shown in the figure below, in normal display mode, the character "Set" on the screen denotes the present output voltage and current setting value while "Next" denotes the next output voltage and current setting value.

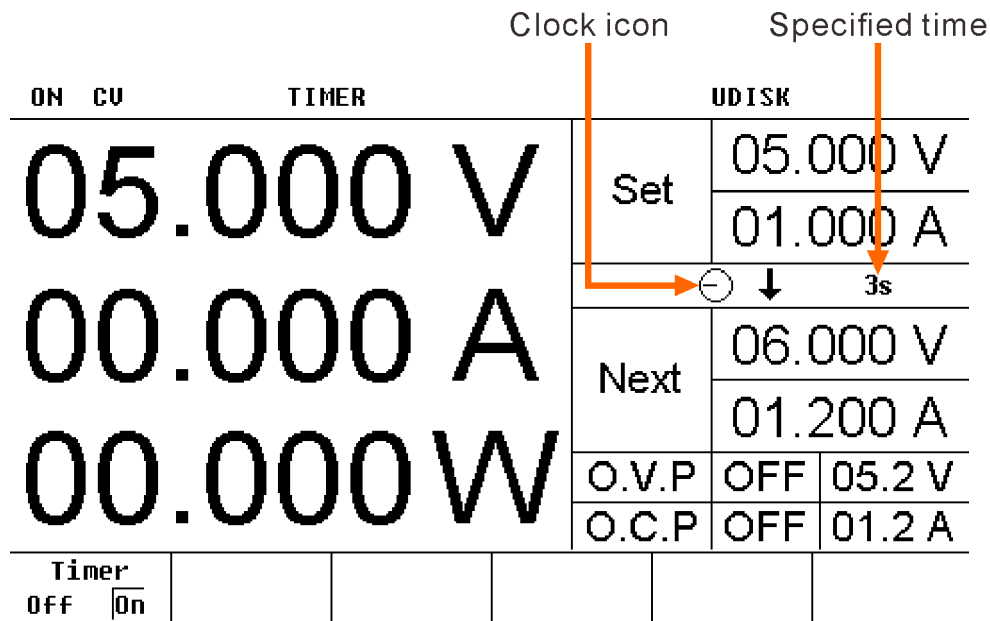

As shown in the figure below, the timing output can be displayed in waveform display mode.

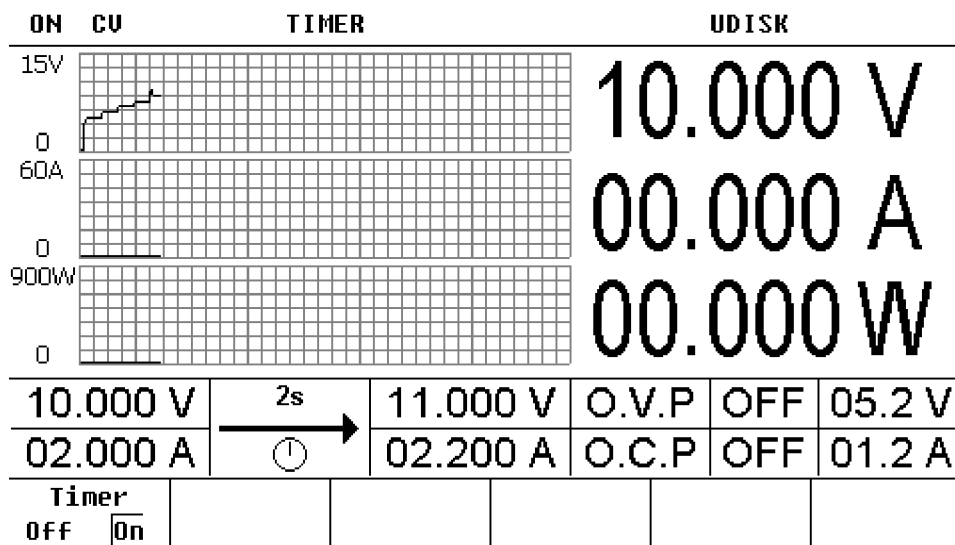

Note:

- Enabling the timer will change the output value of the channel; make sure that the change in the output value will not affect the device connected to the power supply before enabling the timer.
- The timing output is valid only when both the timer and the channel output are turned on.
- When the timer is enabled, the timer parameters cannot be modified.

To Set the Timer Parameters

Press **Timer** → **Timer Setup** to enter the timer parameter setting interface as shown in the figure below. This interface provides timer parameter preview, the horizontal axis denotes groups and the vertical axis denotes voltage and current; users can view the values on the current page of the timer parameter list.

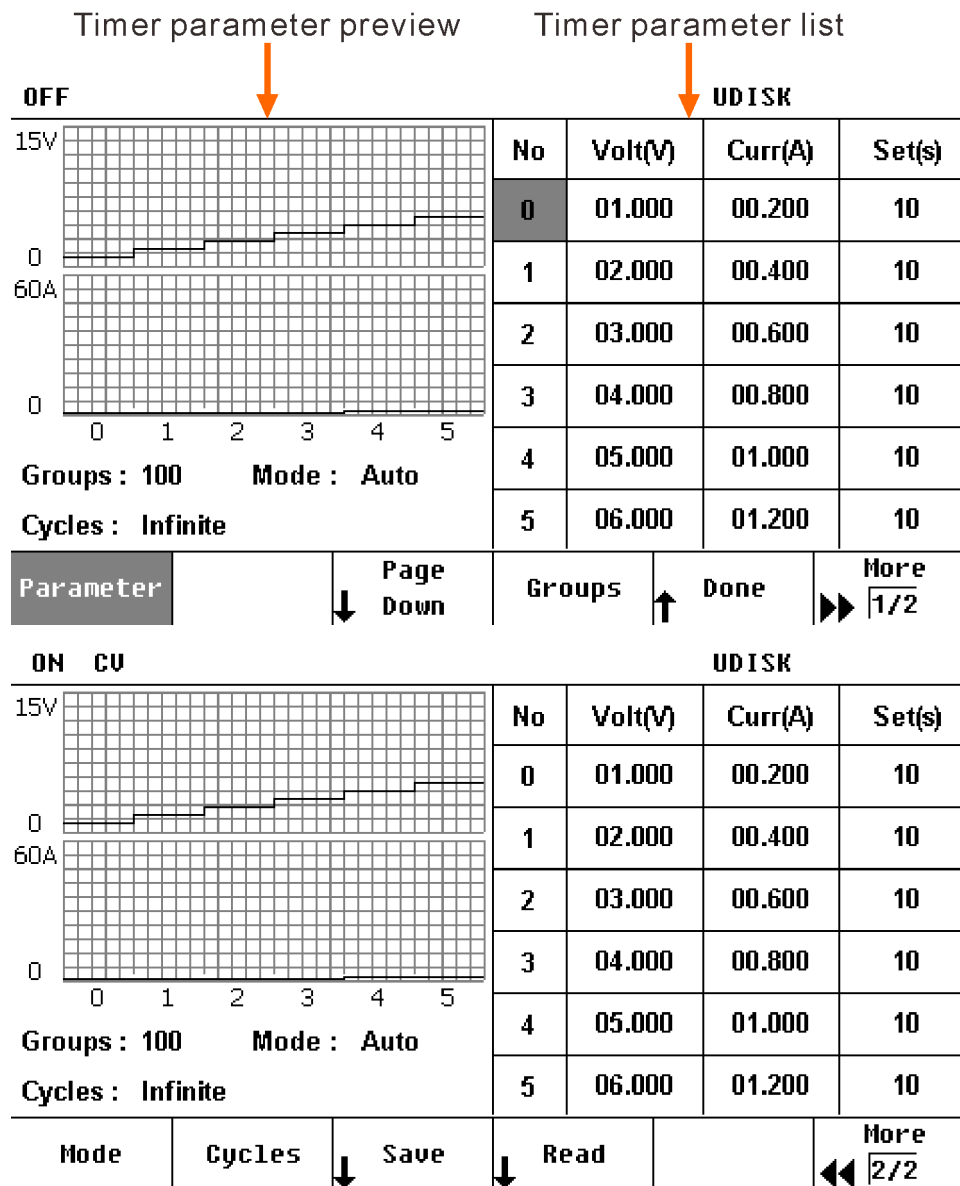

1) Timer parameter

You can edit the timer parameters manually. Press **Parameter** and the knob to select the number (No) in the timer parameter list, use the numeric keyboard or the knob to input the desired group, then press the knob to select the voltage (Volt), current (Curr) and time (Set) of the current group respectively, finally use the numeric keyboard or the knob to input the desired value. Use the same method to set the parameters of the other groups.

You need to set **P** groups (No.0 to No.(P-1)) of timer parameters; wherein, **P** is the number of output groups currently set. Only 6 groups of parameters can be displayed on each page of the timer parameter list and you can press **↑** or **↓** to view and set the parameters of the other groups. This interface provides timer parameter preview; users can view the values on the current page of the timer parameter list (the horizontal axis represents group and the vertical axis represents voltage and current).

2) Output groups

The number of output groups is defined as the number of groups of preset voltage and current values that the power supply outputs in each cycle. Press **Groups** and use knob and the numeric keyboard to input the desired value. The range is from 1 to 100.

3) Running mode

Press **Mode** to select "Auto" or "Step".

- Auto: auto running
- Step: run a step as a trigger occurs

4) Cycles

The number of cycles is defined as the number of times that the power supply performs timing output according to the preset voltage and current. Press **Cycles** to set the number of cycles to "Infinite". Press **Cycles** repeatedly or use the knob or the numeric keyboard to input the desired value. The range is from 1 to 99999.

Note :

- The total number of groups in timing output = the number of output groups × the number of cycles
- The power supply will terminate the timer function when the total number of groups of outputs is finished. At this point, the state of the power supply depends on the setting in "End State".

5) End state

The end state refers to the state of the instrument after it finishes outputting the total number of groups of voltage and current values when the number of cycles is a specified value. Press **End State** to select "Off" or "Last".

- Off: the instrument turns off the output automatically after finishing the output.
- Last: the instrument stops at the output state of the last group after finishing the output.

Note: When the number of cycles is set to "Infinite", the end state is invalid.

6) Save / read

You can store the edited timer parameters in the internal memory and recall them when required.

- Save

After editing the timer parameters, press **Save** to enter the store and recall interface. Please save the timer file according to the introduction in "Save/Recall".

- Read

Press **Recall** to enter the store and recall interface. Please read the desired file according to the introduction in "Save/Read". Users can edit the timer file read.

2-6. Save/Recall

This power supply supports two types of document storage ways: U disk storage and local storage. It can store, recall and delete the system settings such as voltage, current, O.V.P, O.C.P, etc. and timer parameters. Among the internal memory, 10 groups of settings could be saved or recalled and more settings are available for USB device. The 10 groups of settings include 10 state files (STATE1-10), 10 timer files (TIMER1-10) and 10 battery files (BATTERY1-10).

Press **Store** button to enter “Save/Recall” interface as shown in the figure below, the button is light; to exit, press the button again.

When a USB storage device is plugged, “UDISK” displayed in the status bar indicates that a USB storage device is detected, meanwhile Mobile Disk (D:) and file “DC POWER” will be displayed on the screen. The USB storage device relevant operations including save, recall and delete only can be completed in the file “DC POWER”. First time to plug the USB storage device, if there isn't file “DC POWER”, the system will automatically create this file. The filename and suffix must be capital letter or number, long filename is not supported and will be transformed to short filename automatically.

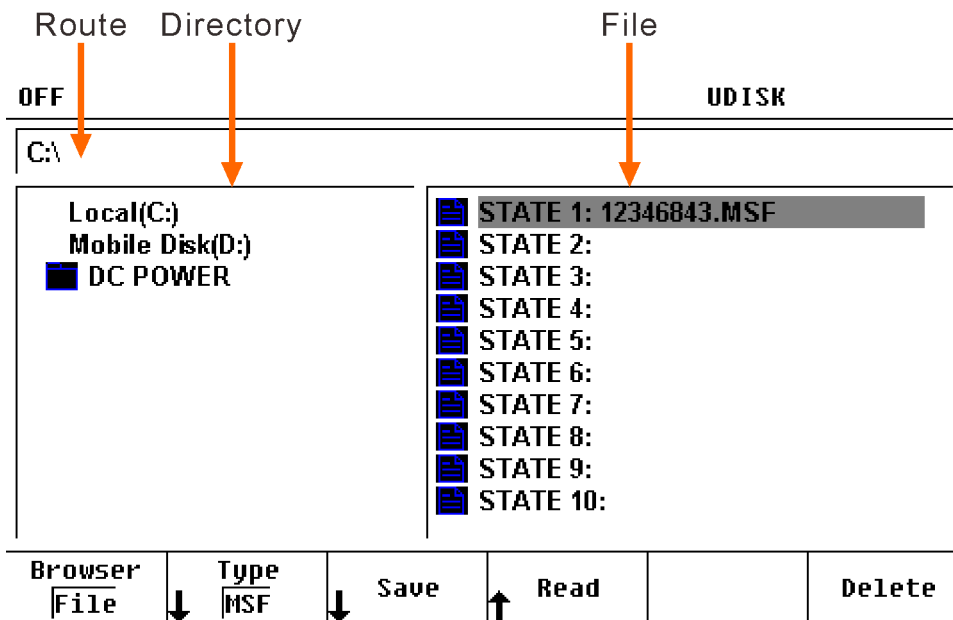

Explanations of save and recall menus

- Browser : Directory area or file filed selection
- Type : Select file type including state file, timer file and battery file
- Save : Store the parameters in the selected storage location
- Read : Read the parameters from the selected storage location
- Delete : Delete the parameters in the selected storage location

Press **Save** to enter the following interface. At this point, rotate the knob to select the desired character.

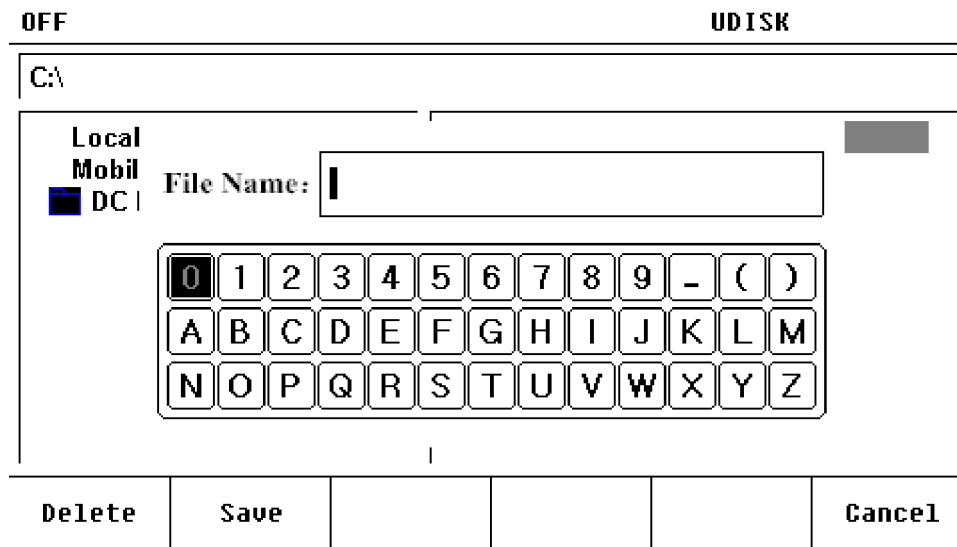

Explanations of virtual keyboard operation

- Delete : Delete the character in front of the cursor in the file name input area
- Save : Save the file as the present file name
- Cancel : Cancel saving and return to the previous interface

The operation steps of each function are shown as below.

1) Save

- Press **Type** to select the desired file type (state file, timer file and battery file).
- Press **Browser** and switch the cursor to file filed, use the knob to select the desired memory location.
- Press **Save** and input the file name by virtual keyboard, then press **Save** again to save parameters.

2) Recall

- Press **Type** to select the desired file type (state file, timer file and battery file).
- Press **Browser** and switch the cursor to file filed, use the knob to select a valid file*. If invalid, the **Read** is hidden automatically.
- Press **Read** to finish.

Note*: the valid file refers to the file that has some parameters stored in.

3) Delete

- Press **Type** to select the desired file type (state file, timer file and battery file).
- Press **Browser** and switch the cursor to file filed, use the knob to select a valid file*. If invalid, the **Read** is hidden automatically.
- Press **Delete** , at this point, the prompt message asking whether to delete the file is displayed, press **Ok** to confirm the delete.

2-7. Utility

Press **Utility** (the light is on) to enter utility interface as the figure below.

ON CU		UDISK	
I/O Config		System	
>>RS232 Baud Rate : 9600 Stop Bit : 1 bit Parity Bit : None >>Trigger Trig Source : External Trig Function : Output		Power On : Default Beeper : On Version : 02 14 01 16_04 Address : 88 Sense : Off Analog Ctrl : Off BackLight : 80 disp W R : disp W VSelfTest : OFF	
↓ I/O Config	↓ System	↓ Error View	↑ Set to Default

Explanations of utility setting menu

- I/O Config : Set I/O configuration and trigger function
- System : Set the system parameters, including power on/off and beeper
- Error View : View error message in remote control mode
- Set to Default : Restore the instrument to factory setting

2-7-1. I/O Setting

Set the RS232 Parameters

Connect the RS232 interface to the PC or data terminal equipment (DTE) using RS232 cable and set the interface parameters (baud rate, parity bit, etc.) that match the PC or terminal equipment. At this point, you can control the instrument remotely.

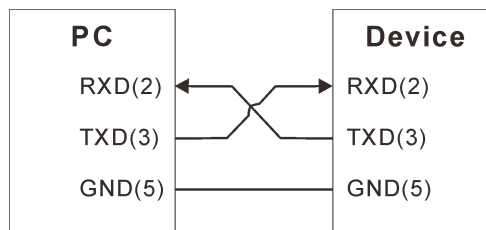

Press **Utility** → **I/O Config** → **RS232** to open the RS232 parameter setting interface.

- 1) Baud rate
Press **Baud Rate** to select the desired baud rate (2400, 9600, 14400, 19200, 38400, 56000, 57600 or 115200, the unit is Baud).
- 2) Stop bit
Press **Stop Bits** to select the desired stop bit (1 or 2).
- 3) Parity
Press **Parity** to select the desired parity mode (None, Even or Odd).

2-7-2. Trigger Function

Set the RS232 Parameters

Connect the RS232 interface to the PC or data terminal equipment (DTE) using RS232 cable and set the interface parameters (baud rate, parity bit, etc.) that match the PC or terminal equipment. At this point, you can control the instrument remotely.

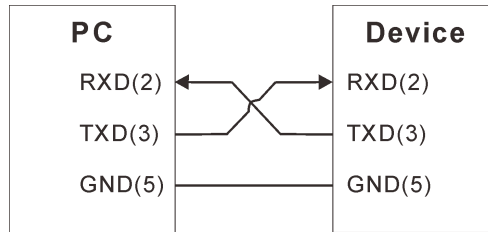

Press **Utility** → **I/O Config** → **Trigger** to open the trigger setting interface.

1) Trigger source

Press **Trigger Source** to select.

- EXT: use the signal input from the TRIG IN rear panel connector.
- Pulse: use TTL signal input from the TRIG IN rear panel connector.
- Bus: uses a signal derived input from the communication port.
- IMM: use command "TRIGger:IMMEDIATE". All other trigger sources are unavailable when IMM is setted.

2) Trigger function

Press **Trigger function** to select.

- Output: change output status.
- Timmer: run the timer parameter list step by step.

2-7-3. System Setting

Press **Utility** → **System** to open the system setting interface as the figure below.

OFF			UDISK		
I/O Config			System		
>>RS232			Power On : Default		
Baud Rate	:	9600	Beeper	:	On
Stop Bit	:	1 bit	Version	:	02 14 01 16_04
Parity Bit	:	None	Address	:	88
>>Trigger			Sense	:	Off
Trig Source	:	External	Analog Ctrl	:	Off
Trig Function	:	Output	BackLight	:	80
			disp W R	:	disp W
			VSelfTest	:	OFF
Power On	Beeper	Address	Sense	↑ Done	More 1/2

ON CU		UDISK			
I/O Config		System			
>>RS232 Baud Rate : 9600 Stop Bit : 1 bit Parity Bit : None >>Trigger Trig Source : External Trig Function : Output		Power On : Default Beeper : On Version : 02 14 01 16_04 Address : 88 Sense : Off Analog Ctrl : Off BackLight : 80 disp W R : disp W VSelfTest : OFF			
Analog Control	BackLight	Disp W R	VSelfTest	More ◀◀ 2/2	

Power-on setting

Press **Utility**→**System**→**Power On** to select the instrument configuration (“Default” or “Last”) the instrument uses at power-on and the default is “Default”.

- Last: use the system configuration before the last power-off.
- Default: use the factory setting (except those parameters that are not affected by factory reset).

Beeper

Press **Utility**→**System**→**Beeper** to enable or disable the beeper. When the beeper is enabled, the instrument generates prompt sound when error occurs during front panel operation or remote operation.

Address

Press **Utility**→**System**→**Address** and use the knob or numeric key to modify the address of instrument.

Sense

Press **Utility**→**System**→**Sense** to enable or disable the remote sensing function. For the details, refer to section 2.9 “Remote Sensing Function”.

Analog control

Press **Utility**→**System**→**Analog Control** to enable or disable the analog control function. For the details, refer to section 2.10 “Analog Control Function”.

Backlight

Press **Utility**→**System**→**BackLight** and use the knob or numeric key to adjust the backlight.

Parameter display selection

Press **Utility**→**System**→**Disp W R** to select the displayed parameter, by power or resistance.

Output voltage self test

Press **Utility**→**System**→**VSelfTest** to to enable or disable output voltage self test function. When output voltage self test is enabled, the device will monitor the output voltage at output terminal and adjust the output accordingly, to minimize the error between real output value and setting output value.

2-7-4. Restore to Factory setting

Press **Utility** → **Set to Default** to restore the instrument to factory setting. Factory setting is shown as below:

Parameters	
Voltage setting value	05.000V
Current setting value	01.000A
Voltage limits	05.2A
Current limits	01.2A
O.V.P On/Off	Off
O.C.P On/Off	Off
Output On/Off	Off

Timer	
Timer On/Off	Off
Output groups	100
Timer parameter	Voltage, current, time (different models maybe have different values)
Running mode	Auto
Cycles	Infinite
End state	Off

I/O configuration	
RS232*	
Baud rate	9600
Stop bit	1bit
Parity bit	None

Trigger	
Trigger source	EXT
Trigger mode	Output

System setting	
Power-on setting*	Default
Beeper	On
Address	88
Sense	Off
Analog control	Off
Backlight	80
Parameter display	Disp W
VSelfTest	Off

Note*: These parameters are not affected by factory reset.

2-8. Auxiliary Function

The auxiliary function contains battery charge function and can expand other functions according to user's need. Press to enter auxiliary function setting interface, the button light goes on.

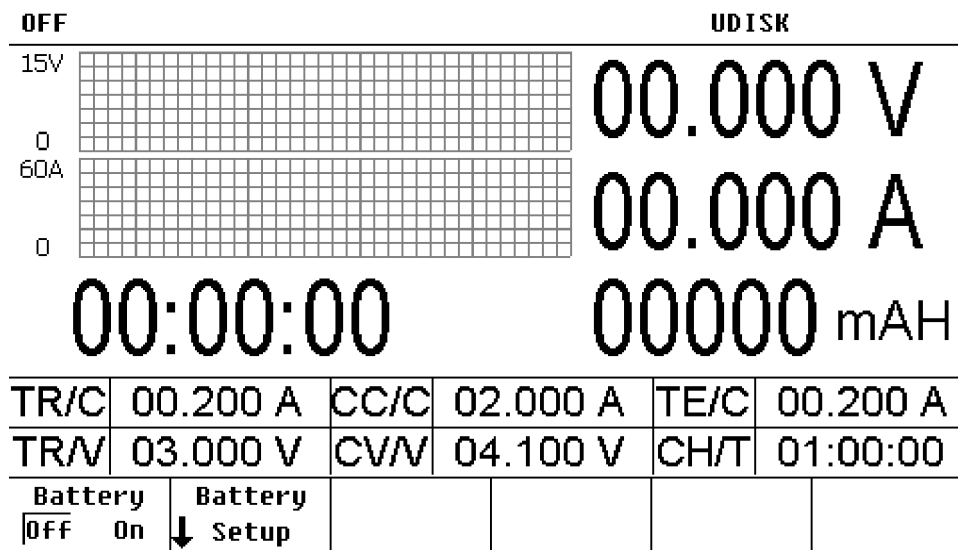

2-8-1. Battery Curved Charge Function

This instrument provides battery charge function as shown in the figure below. It can effectively protect the battery.

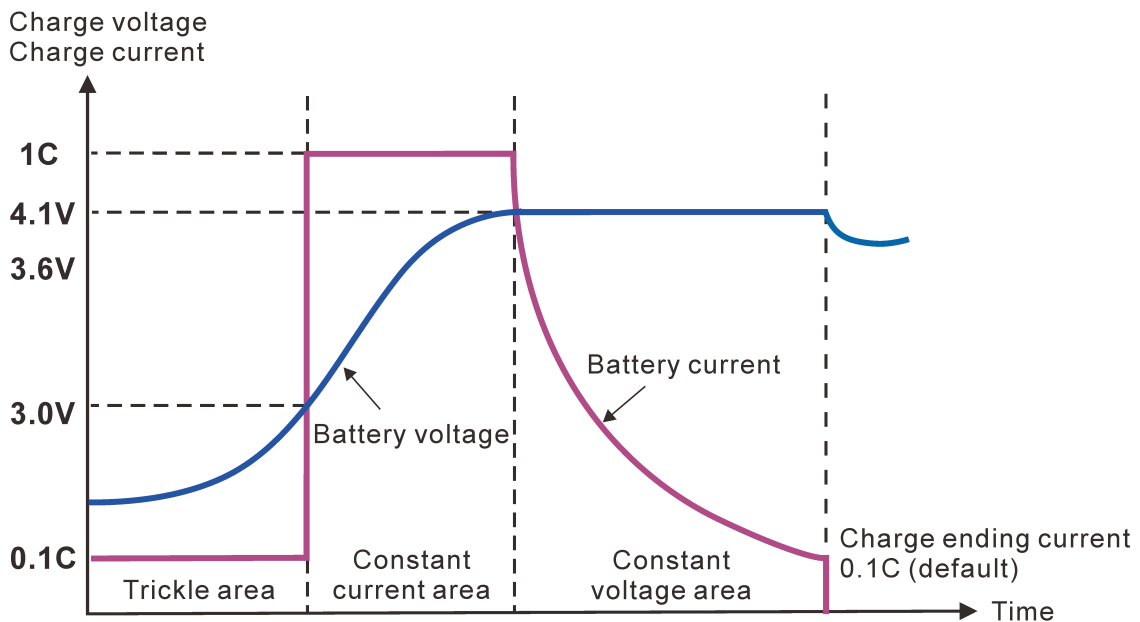

Operation steps:

1) Press **...** → **Battery Setup** to enter parameter setting interface.

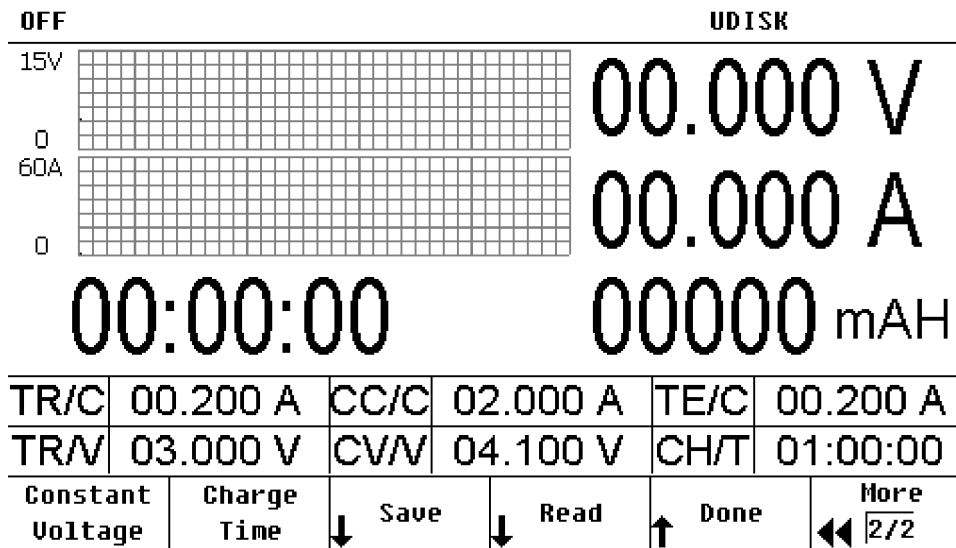
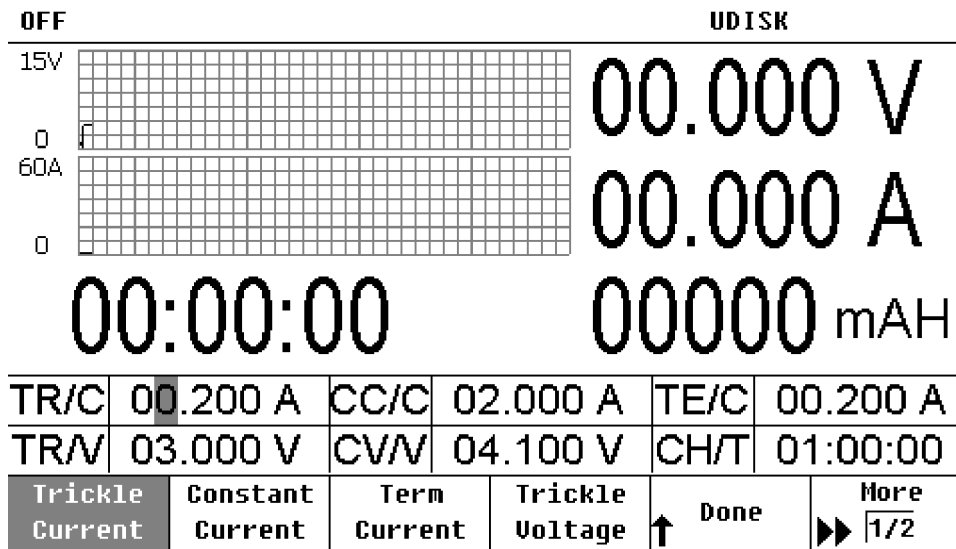

Explanations:

Parameters	Menu	Display
Trickle charge current	Trickle Current	TR/C
Standard charge current	Constant Charge	CC/C
Terminated current threshold	Term Current	TE/C
Trickle charge voltage threshold	Trickle Voltage	TR/V
Floating charge voltage	Constant Voltage	CV/V
Charge time	Charge Time	CH/T

2) Press **Battery On/Off** and select "On" to start the battery charge function. Connect the battery to the instrument, the voltage of battery is displayed on the screen, pressing "ON/OFF" button starts charging.

2-9. Remote Sensing Function

This power supply provides high output current, so the voltage drop on the load lead cannot be ignored. When the output current of the power supply is high, to ensure that the load can acquire the correct voltage drop, the instrument provides the Sense (remote sense) working mode. In this mode, the instrument can automatically compensate for the voltage drop caused by the load lead to ensure that the power supply output value set by users is consistent with the voltage acquired by the load.

Before using the remote sensing function, make sure that the power supply is under remote sensing mode. Before set the remote sensing function, the output must be turned OFF. The remote sensing cable is suggested not to twist the remote sensing cable with connecting cable of the load.

Connecting illustration for remote sensing:

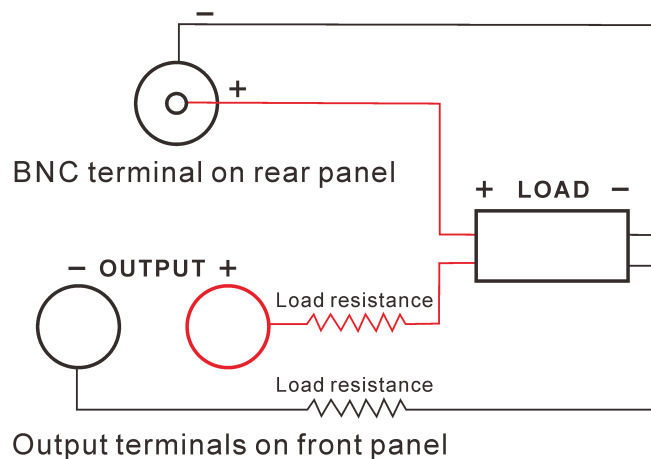

Operation steps:

- 1) Connect the output terminals on front panel and Sense terminal on rear panel to the two ends of the load respectively, as shown in the figure above. Pay attention to the polarity when making connections.
- 2) Press **Utility** → **System** → **Sense** to enable or disable the remote sensing function.

2-10. Analog Control Function

Press **Utility**→**System**→**Analog Control** to enable or disable the analog control function.

There is a 9pin aviation plug used as analog control interface on the rear panel. It can enable you to control the output voltage and current, and realize the parallel connection among many power supplies that have the identical voltage and current ratings.

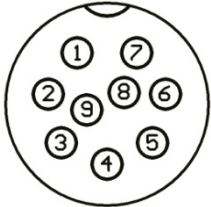

The definitions for the pins are shown as below:

- 1 +5VDC, provides 5V reference voltage.
- 2 To adjust the output voltage: externally connect 0-5V voltage or 0-5K Ω resistance to adjust 0-100% voltage maximum ratings.
- 3 To adjust the output current: externally connect 0-5V voltage or 0-5K Ω resistance to adjust 0-100% current maximum ratings.
- 4 GND: Common ground
- 5 When "Analog Ctrl" is set to ON, controlling the ON/OFF, short Pin5 and GND, the output is ON, on the contrary the output is OFF. When "Analog Ctrl" is set to OFF, controlling the output signal, the output is ON and the output voltage is 0V, and the output voltage is 5V when the output is OFF.
- 6 Power supply OK, to indicate the output status: if the power supply is OK, the output is 5V; if the power supply is protected or damaged, the output is 0V.
- 7 To Indicate CV/CC mode: connect Pin7 to GND, in CV mode, the voltage is 5V and the voltage is 0V in CC mode.
- 8 To monitor the corresponding voltage of actual output voltage: 0-5V voltage to monitor 0-100% voltage maximum ratings.
- 9 To monitor the corresponding voltage of actual output current: 0-5V voltage to monitor 0-100% current maximum ratings.

3. REMOTE CONTROL

With the remote control function provided, this series power supply can communicate with PC by RS232 interface and enable all the panel operations by series port software.

3-1. Interface Setting

3-1-1. Interface

The RS232 interface is installed on the real panel of instrument.

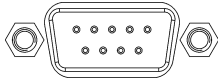

RS232 interface

3-1-2. COM Port Setting

Set up the COM port inside PC according to the following list.

- 1) Baud rate: 9600
- 2) Parity bit: None
- 3) Data bit: 8
- 4) Stop bit: 1
- 5) Data flow control: None

Note 1: If the power supply has no response under the remote control, please check the following items.

- Check whether the connection cable is broken off or not.
- Check whether the connection cable is crossover cable.
- Check whether the pin connection among interface cable, power cord and PC is correct or not.
- Check whether the interface cable is properly connected or not.
- Check whether the communication parameters setup is compliant to COM port setting or not.
- Check whether the end character is line break or not (hexadecimal 0X0A).

Note 2: When the remote controller is on line, the **[Lock]** button backlight turns on and the operation can only be proceeded through it. At this time, all the panel operations are closed unless the **[Lock]** button is pressed again.

3-2. SCPI Commands

For detailed SCPI commands, please refer to the programming software in the CD ROM attached to the instrument.

4. MAINTENANCE

4-1. Inspection

- Inspect the instrument at regular intervals so that it maintains its initial performance for a long time.
- Check the input power cord for damage of the vinyl cover and overheating of the plug and cord stopper.
Check the terminal screws and binding posts for loosening.

4-2. Fuse Replacement

Step (1) Take off the power cord and remove the fuse socket using a minus driver.

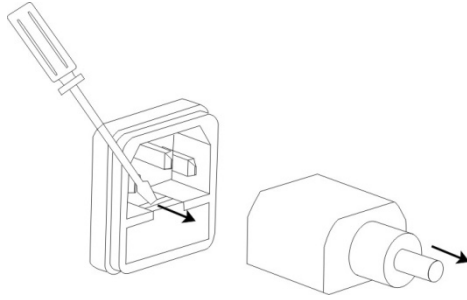

(2) Replace the fuse in the holder.

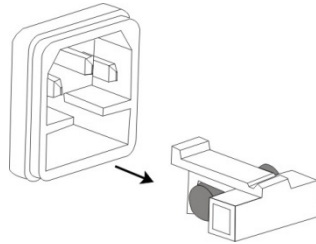

Fuse rating

220V: For models PPS-2030, 3010, 3020, 6010, 8008: T4AL/250V
For models PPS-1560, 2045, 3030, 6015, 8011: T8AL/250V

5. SPECIFICATIONS

The specifications are warranted when the power supply series are powered on for at least 30 minutes under regulated temperature.

Specifications (600W)

Model	PPS-2030	PPS-3010	PPS-3020	PPS-6010	PPS-8008
Rated output (0°C~40°C)					
Voltage	0~20V	0~30V	0~30V	0~60V	0~80V
Current	0~30A	0~10A	0~20A	0~10A	0~7.5A
O.V.P	0.1~24V	0.1~34V	0.1~34V	0.1~64V	0.1~88V
O.C.P	0.1~34A	0.1~12A	0.1~24A	0.1~12A	0.1~8.8A
Constant Voltage Operation					
Line regulation	≤0.01%+4mV				
Load regulation	≤0.1%+5mV				
Ripple & Noise (20Hz~20MHz)	2mVrms, 30mVpp				
Recovery time	≤1.5ms (50% load change)				
Constant Current Operation					
Line regulation	≤0.2%+3mA				
Load regulation	≤0.2%+5mA				
Ripple & Noise	≤10mArms				
Display					
Voltmeter	5 digits LCD display				
Ammeter	5 digits LCD display				
Setting resolution	1mV/1mA				
Reading resolution	1mV/1mA				
Setting accuracy (25±5°C)	Voltage	±(0.03% of reading + 10mV)			
	Current	±(0.3% of reading + 10mA)			
Reading accuracy (25±5°C)	Voltage	±(0.02% of reading +5mV)			
	Current	±(0.3% of reading +10mA)			
General					
Protection	Over load, over voltage, over current, over temperature and reverse polarity protections				
Panel lock	Provided				
Remote sense function	Maximum compensation voltage 0.1V@ Maximum output				
Battery charge	Lithium battery curve charge				
Interface	RS232 interface, Support SCPI commands				
	0-5V analog control				
	Optional RS485 interface, support ModBus				
	Optional RS232 to USB cable				
Memory	100 sets internal save, support save to USB flash driver				
Insulation	Between base and terminals: ≤60VDC				
Operating environment	Indoor use	Altitude: ≤2000m	Ambient temperature: 0~40°C		
	Relative humidity: ≤80%	Installation category: II	Pollution degree: 2		
Storage environment	-10°C~70°C, ≤70%RH				
Power source	AC220V±10%, 50/60Hz				
Accessories	Power cord x1, Operation manual x1, RS232 cable x1, Software CD x1				
Dimension (WxHxD)	215x89x352mm				
Weight	4.5kg				

Specifications (900W)

Model	PPS-1560	PPS-2045	PPS-3030	PPS-6015	PPS-8011
Rated output (0°C~40°C)					
Voltage	0~15V	0~20V	0~30V	0~60V	0~80V
Current	0~60A	0~45A	0~30A	0~15A	0~11A
O.V.P	0.1~18V	0.1~24V	0.1~34V	0.1~64V	0.1~88V
O.C.P	0.1~62 A	0.1~50A	0.1~34A	0.1~17A	0.1~12A
Constant Voltage Operation					
Line regulation	≤0.01%+4mV				
Load regulation	≤0.1%+5mV				
Ripple & Noise (20Hz~20MHz)	2mVrms, 30mVpp				
Recovery time	≤1.5ms (50% load change)				
Constant Current Operation					
Line regulation	≤0.2%+3mA				
Load regulation	≤0.2%+5mA				
Ripple & Noise	≤10mArms				
Display					
Voltmeter	5 digits LCD display				
Ammeter	5 digits LCD display				
Setting resolution	1mV/1mA				
Reading resolution	1mV/1mA				
Setting accuracy (25±5°C)	Voltage	±(0.03% of reading + 10mV)			
	Current	±(0.3% of reading + 10mA)			
Reading accuracy (25±5°C)	Voltage	±(0.02% of reading +5mV)			
	Current	±(0.3% of reading +10mA)			
General					
Protection	Over load, over voltage, over current, over temperature and reverse polarity protections				
Panel lock	Provided				
Remote sense function	Maximum compensation voltage 0.1V@ Maximum output				
Battery charge	Lithium battery curve charge				
Interface	RS232 interface, Support SCPI commands				
	0-5V analog control				
	Optional RS485 interface, support ModBus				
	Optional RS232 to USB cable				
Memory	100 sets internal save, support save to USB flash driver				
Insulation	Between base and terminals: ≤60VDC				
Operating environment	Indoor use	Altitude: ≤2000m	Ambient temperature: 0~40°C		
	Relative humidity: ≤80%	Installation category: II	Pollution degree: 2		
Storage environment	-10°C~70°C, ≤70%RH				
Power source	AC220V±10%, 50/60Hz				
Accessories	Power cord x1, Operation manual x1, RS232 cable x1, Software CD x1				
Dimension (WxHxD)	215x89x412mm				
Weight	5.5kg				

For the purpose of product improvement, specifications are subject to change without prior notice.



Twintex Electronics Co., Ltd

Add.: 702, #16-21, Block B, Sanhehuaqiao Village, Dalang Sub-district,

Longhua District, Shenzhen, China 518109

Tel: +86-755-28129890

Fax: +86-755-28149802

Web: www.twintex.com.tw