

R&S® ZNL VECTOR NETWORK ANALYZER

The 3-in-1 allrounder

3
year
warranty



Data Sheet
Version 05.00

ROHDE & SCHWARZ

Make ideas real



AT A GLANCE

Measuring equipment for RF applications must satisfy high quality standards. Instruments should be easy to use and offer high versatility. Fast measurements and reliable performance are crucial. The R&S®ZNL meets these challenges and offers even more: it combines the functionality of a vector network analyzer, a spectrum analyzer and a power meter in a single, compact box.

With frequency ranges from 5 kHz to 3 GHz, 4.5 GHz or 6 GHz, the R&S®ZNL is well suited for RF component tests in industrial electronics and wireless communications.

Responding to constantly changing measurement needs in diverse environments, e.g. on test benches or production lines, can be challenging. The R&S®ZNL helps to reduce investment costs as it offers a unique option concept. The base unit can be extended with a fully integrated spectrum analyzer¹⁾. Moreover, the R&S®ZNL can be used as an RF power meter²⁾.

¹⁾ R&S®ZNL3-B1, R&S®ZNL4-B1 or R&S®ZNL6-B1 option.

²⁾ R&S®FPL1-K9 option; requires R&S®ZNL3-B1, R&S®ZNL4-B1 or R&S®ZNL6-B1 option and an R&S®NRP external power sensor.

Instead of investing in multiple instruments, research labs, service centers, universities and production facilities can benefit from a single, compact instrument that offers even higher measurement speed and better RF performance than dedicated instruments in comparable classes.

The instrument simultaneously displays vector network analysis and spectrum analysis measurements on its 10.1" multitouch screen. Clear menu structures and numerous wizards make measurements convenient to configure.

Although the R&S®ZNL hosts a variety of different functionalities, it is a very compact instrument with an attractive form factor. With a weight of only 6 kg to 8 kg, a carrying handle and an optional battery pack, the R&S®ZNL is fully portable and can be operated wherever needed.

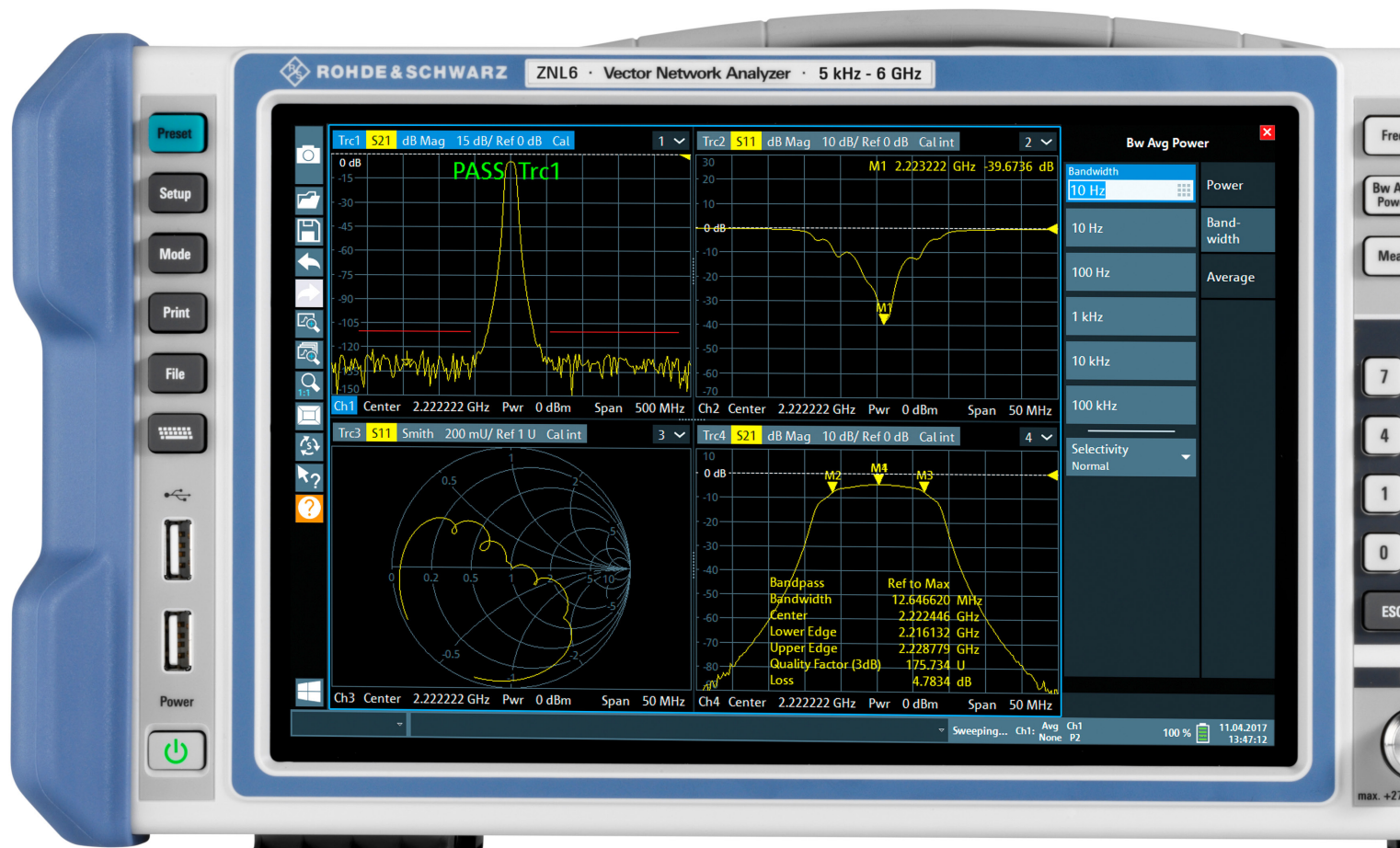

Key features

- ▶ Frequency range from 5 kHz to 3 GHz (R&S®ZNL3), 4.5 GHz (R&S®ZNL4) or 6 GHz (R&S®ZNL6)
- ▶ Two-port vector network analyzer for bidirectional measurements
- ▶ Universal instrument
 - Vector network analyzer
 - Fully integrated spectrum analyzer (optional, for R&S®ZNL3, R&S®ZNL4 and R&S®ZNL6)
 - Support for external power sensor
- ▶ Wide dynamic range of typ. 130 dB
- ▶ Output power range from -40 dBm to typ. + 3 dBm
- ▶ Measurement bandwidths from 1 Hz to 500 kHz
- ▶ Fast measurements, e.g. 16.7 ms for 401 points (100 kHz IFBW, 200 MHz span, 2-port TOSM (SOLT))
- ▶ Compact size, low weight (6 kg to 8 kg)
- ▶ Optional battery pack
- ▶ Windows 10 operating system



BENEFITS

The 3-in-1 analyzer: compact vector network analyzer

- ▶ Solid RF performance
- ▶ Versatile features for lab and production
- ▶ Time domain analysis and distance-to-fault (DTF) measurements
- ▶ Compact 3-in-1 instrument
- ▶ Remote control via LAN and optional GPIB interface
- ▶ [page 4](#)

The 3-in-1 analyzer: fully integrated spectrum analyzer

- ▶ Integrated hardware for solid RF performance
- ▶ Spectrum analyzer function
- ▶ Analog demodulation
- ▶ Digital demodulation
- ▶ [page 6](#)

The 3-in-1 analyzer: RF power meter

- ▶ Precise power measurements
- ▶ [page 7](#)

User interface with multitouch screen

- ▶ Clear menu structures for efficient operation
- ▶ Large 10.1" multitouch screen for convenient operation
- ▶ Integrated PC
- ▶ Simultaneous display of multiple measurement modes with MultiView function
- ▶ [page 10](#)

Fully portable – ideal for field use

- ▶ Battery and DC power supply for field use
- ▶ Accessories for transport and field use
- ▶ [page 11](#)

THE 3-IN-1 ANALYZER: COMPACT VECTOR NETWORK ANALYZER

The R&S®ZNL combines the functionality of a vector network analyzer, a spectrum analyzer and a power meter in a single, compact box. The all-in-one instrument is ideal for environments that involve constantly changing test requirements in development, production and service.

Solid RF performance

Vector network analyzers such as the R&S®ZNL can characterize electronic networks in the frequency domain, e.g. by measuring the magnitude and phase of S-parameters. Components can also be analyzed in the time domain with the R&S®ZNL-K2 option.

Measurement on a high-rejection bandpass filter using the bandpass filter function.

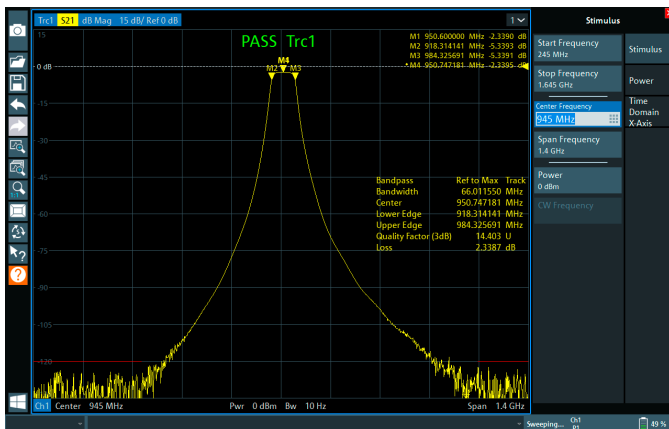

High dynamic range

The R&S®ZNL features a wide dynamic range of up to 130 dB (typ. at 10 Hz IFBW) and an output power of typ. 3 dBm. These values facilitate measurements on high-rejection filters that call for a wide dynamic range.

Low trace noise for high accuracy

The R&S®ZNL offers low trace noise of less than 0.0005 dB (typ. at 10 kHz IFBW). This delivers stable, reproducible and precise measurements even at higher IF bandwidths. Using higher IF bandwidths, the R&S®ZNL can perform faster measurements while maintaining the stability normally only achieved with narrower IF bandwidths.

Fast measurements for high throughput

With measurement times of e.g. 16.7 ms for 401 points (full two-port calibration, 200 MHz span, 100 kHz IFBW), high-speed data processing and fast LAN or IEC/IEEE/ GPIB data transfer, the R&S®ZNL meets the speed requirements encountered in production. Throughput can be maximized by using the segmented sweep function. Here, the frequency axis is divided into segments, and sweep parameters such as output power, IF bandwidth and number of points can be defined separately for each segment to optimally match the DUT characteristics. This increases measurement speed without any loss in accuracy.

Fixture compensation menu, showing the available compensation methods.

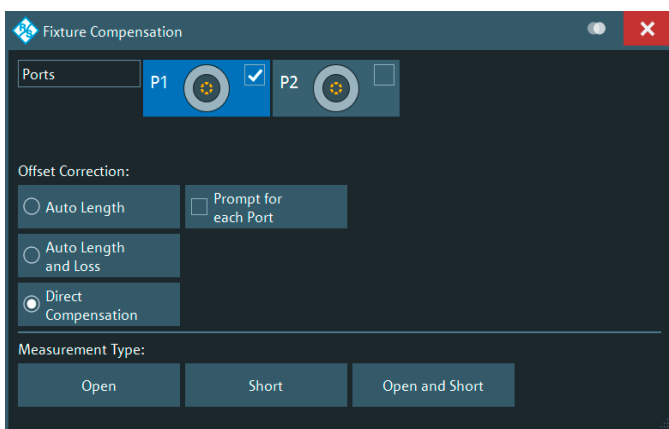

Features for production and lab

Versatile calibration features, support for calibration units

The R&S®ZNL calibration wizard guides users through the calibration process. Manual calibration kits and automatic calibration units are supported. Using a calibration unit minimizes the time needed to perform full system error correction. The calibration unit is ready for use right after it is connected to the R&S®ZNL. Calibrating a setup takes just a few steps. This is especially advantageous in production environments, helping to save time and maximize throughput. The calibration unit performs calibration with a single click on the “Start Auto Cal” button.

De/embedding and fixture compensation

Components are often specified together with the networks that match them to the impedance of the surrounding circuit. To characterize such components in a production environment, the R&S®ZNL can embed the DUT into a virtual matching network to provide realistic conditions by simulating the DUT installed in its operational environment. The R&S®ZNL offers a choice of predefined matching network topologies. It is also possible to read touchstone files into the R&S®ZNL and use them for deembedding/embedding. In addition, fixture compensation is available for correcting measurement results. This feature eliminates the unwanted effects of a test fixture or adapter located between the calibrated reference plane and the DUT.

Remote control via LAN and optional GPIB interface

The R&S®ZNL can be remotely controlled via its standard LAN interface. The optional GPIB interface can be used to connect a controller for remote control of the R&S®ZNL. Data is transmitted bidirectionally on the 8-bit parallel bus. The data measured during a sweep is transferred to the controller while the next sweep is in progress. As a result, data transfer time on the R&S®ZNL is virtually negligible.

Time domain analysis and distance-to-fault (DTF) measurements

The R&S®ZNL offers powerful time domain analysis (R&S®ZNL-K2 option) to measure components such as filters and high-speed digital data cables in the frequency and time domain.

With 100 001 points per trace, the R&S®ZNL can measure electrically long DUTs such as long cables without any limitations. The gating function of the R&S®ZNL makes it easy to locate cable faults and analyze them in detail.

The distance-to-fault measurements option (R&S®ZNL-K3) allows the detection of cable discontinuities, which is important for base station antenna installation, for example. Users can select from a range of common cable types with predefined velocity factor and frequency-dependent attenuation, or create their own cable profiles. The R&S®ZNL-K2 and R&S®ZNL-K3 options use internal DC extrapolation. The low start frequency of 5 kHz is helpful as it provides improved accuracy.

Compact 3-in-1 instrument

With a depth of less than 24 cm and a weight of only 6 kg to 8 kg, the R&S®ZNL is the most compact instrument in its class. The small footprint leaves plenty of space on the workbench – more than with any other comparable benchtop analyzer.

With the R&S®ZNL3-B1, R&S®ZNL4-B1 or R&S®ZNL6-B1 spectrum analyzer option installed, even more space is saved as the instrument offers the functionality of two analyzers in the same compact size. Adding support for R&S®NRP power sensors additionally provides power meter functionality, turning the R&S®ZNL into a 3-in-1 allrounder with a network analyzer, spectrum analyzer and power meter in a single box.

Comparison of footprint of different VNAs

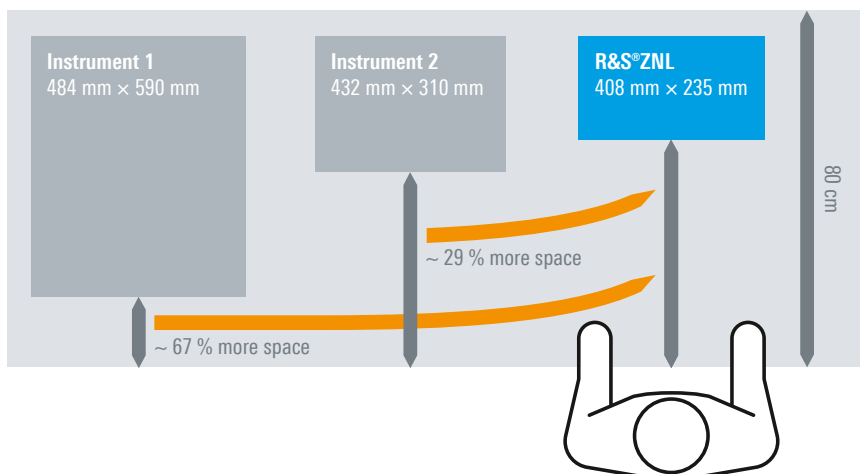

THE 3-IN-1 ANALYZER: FULLY INTEGRATED SPECTRUM ANALYZER

Different modes of operation turn the R&S®ZNL vector network analyzer into a versatile multipurpose instrument. The R&S®ZNL3-B1/R&S®ZNL4-B1/R&S®ZNL6-B1 hardware option extends the base unit with a fully integrated spectrum analyzer on a dedicated hardware board. There is no need to reboot the instrument in order to switch between different modes.

Integrated hardware for solid RF performance

The R&S®ZNL3-B1, R&S®ZNL4-B1 and R&S®ZNL6-B1 options are dedicated hardware boards, delivering performance comparable to that of pure spectrum analyzers in the economy and midrange classes. The R&S®ZNL equipped with the spectrum analyzer hardware features a phase noise of typ. -108 dBc (1 Hz) at 10 kHz offset, a third-order intercept point of typ. $+20$ dBm, and a displayed average noise level (DANL) of typ. -150 dBm.

Spectrum analyzer function

In the spectrum analyzer mode, the instrument provides functions corresponding to those of a conventional spectrum analyzer. The analyzer measures the frequency spectrum of the RF input signal over the selected frequency range with the selected resolution and sweep time. Alternatively, it displays the waveform of the video signal for a fixed frequency. This application requires the R&S®ZNL3-B1, R&S®ZNL4-B1 or R&S®ZNL6-B1 spectrum analyzer option.

Spectrum analyzer mode: the R&S®ZNL provides the full functionality of a standard spectrum analyzer.

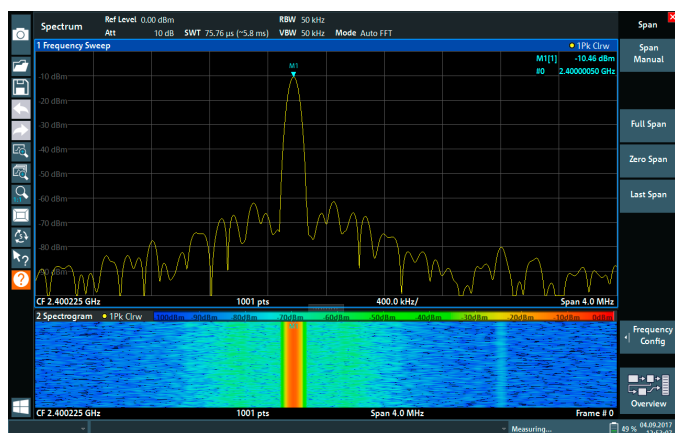

The spectrum analyzer function includes an I/Q analyzer, which is the standard function for digital signal analysis. This application provides measurement and display functions for I/Q data. The captured I/Q data can be transferred to third-party software tools (e.g. MATLAB® or Python) for further analysis. The 40 MHz analysis bandwidth option (R&S®FPL1-B40) allows single-carrier signals with up to 40 MHz bandwidth to be analyzed and demodulated.

Analog demodulation

The R&S®FPL1-K7 option adds analog demodulation capabilities to the R&S®ZNL. It determines the characteristics of amplitude, frequency and phase modulated signals and also measures other components such as residual FM and synchronous modulation. Typical applications of the R&S®FPL1-K7 include:

- ▶ Transient and settling time measurements of oscillators like VCOs and PLLs
- ▶ Troubleshooting of AM/FM transmitters
- ▶ Simple chirp analysis of pulsed and continuous wave signals

Digital demodulation

The R&S®ZNL equipped with an R&S®ZNL3-B1, R&S®ZNL4-B1 or R&S®ZNL6-B1 option can analyze and demodulate digitally modulated single-carrier signals with up to 40 MHz analysis bandwidth. The R&S®ZNL receives and digitizes the signal, which is then analyzed by the R&S®VSE vector signal explorer software with the R&S®VSE-K70 and/or R&S®VSE-K106 option. The software runs directly on the R&S®ZNL or an external PC.

Overview of analog demodulation menu: all setting functions are accessible here.

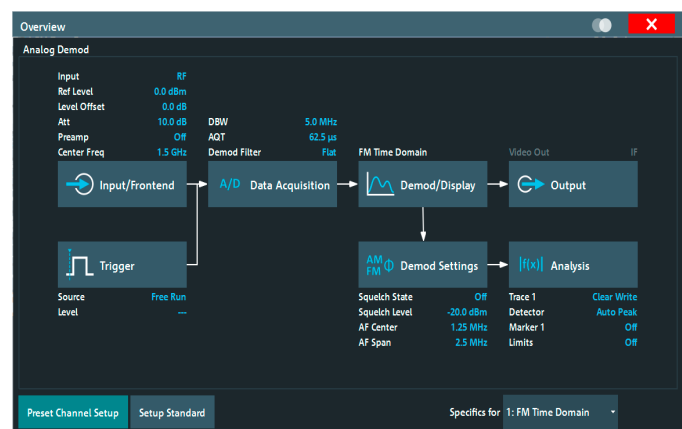

THE 3-IN-1 ANALYZER: RF POWER METER

Precise power measurements

The R&S®FPL1-K9 option adds support for R&S®NRP power sensors¹⁾, enabling precise power measurements. This application requires the R&S®ZNL3-B1, R&S®ZNL4-B1 or R&S®ZNL6-B1 spectrum analyzer option to be installed.

Power sensors can be connected via USB or via the ruggedized power sensor connector included in the R&S®FPL1-B5 additional interfaces option.

Up to four power sensors can be connected in parallel. Power sensors can also be used to trigger measurements at defined power levels.

¹⁾ The R&S®NRP power sensors supported by R&S®FPL1-K9 are listed in the R&S®ZNL data sheet PD 3607.17071.22.

Examples of R&S®NRP power sensors:
R&S®NRP8SN and R&S®NRP8S three-path diode power sensors



The R&S®ZNL with the R&S®FPL1-K9 option supports external R&S®NRP power sensors to deliver precise power measurements.

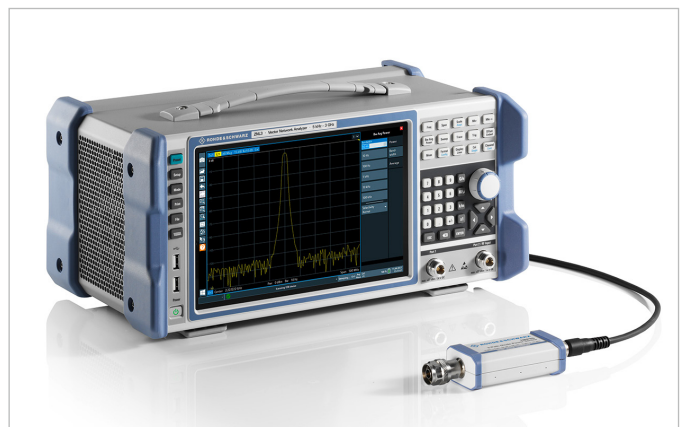

CLEARLY STRUCTURED USER INTERFACE

10.1" high-resolution multitouch screen

- ▶ 1280 × 800 pixel

Toolbar

- ▶ Fast access to standard functions such as print, save/open file, undo, redo, help

System keys

- ▶ For setups, presets, etc.

Two USB 2.0 ports

- ▶ For storage media
- ▶ For accessories

Status bar



Softkey bar

- ▶ Quick access to key functions
- ▶ Hardware settings at a glance

Numerical keypad

- ▶ With unit keys for frequency and level

Function keys

Control knob

Port 1

Port 2/RF input



USER INTERFACE WITH MULTITOUCH SCREEN

Clear menu structures for efficient operation

The R&S®ZNL has a clearly structured user interface. Measurements can be configured in just a few steps.

Users can drag and drop traces, channels and diagrams to arrange and combine them in any desired way. Different instrument setups can be saved and reloaded, and switching between setups is possible with minimal effort.

The R&S®ZNL offers a variety of marker functions for efficient analysis of the measured trace:

- ▶ Up to ten markers per trace are available. Results are represented in different formats such as magnitude, phase, impedance, admittance and VSWR.
- ▶ The unit of the marker can be chosen independently of the displayed trace format.
- ▶ Markers and traces can be named to describe the specific application.
- ▶ Available marker functions include maximum, minimum, RMS and peak-to-peak detection, as well as bandwidth measurement, etc.

Moreover, the user can define limit lines to verify compliance of the DUT with specified values and required standards.

Large 10.1" multitouch screen for convenient operation

The large 10.1" multitouch screen allows users to arrange measurement tasks as required and move and combine traces, channels and diagrams by using the drag & drop function.

Integrated PC

With its fully integrated, powerful PC platform running the Windows 10 operating system, the R&S®ZNL is a stand-alone solution. There is no need for an external PC or controller. The analyzer's solid state hard disk ensures fast boot-up time and high reliability to satisfy the most demanding requirements.

Simultaneous display of multiple measurement modes with MultiView function

To support full DUT characterization, the MultiView function simultaneously displays all active vector network analyzer, spectrum analyzer and power meter measurements. Measurements are updated in real time and can be accessed directly by tapping on the desired window.

With the test sequencer activated in MultiView mode, vector network analyzer measurements and spectrum analyzer measurements can be performed alternately.



In MultiView mode, all active measurements are displayed at the same time. Here, a vector network analyzer measurement (two different representations) is displayed along with a spectrum analyzer measurement.

FULLY PORTABLE – IDEAL FOR FIELD USE

Due to its unique hardware concept, the R&S®ZNL combines multiple functionalities in a compact form factor. Its weight is correspondingly low. Depending on the options installed, the R&S®ZNL weighs between 6 kg and 8 kg.

Battery and DC power supply for field use

With a carrying handle and an optional battery pack (R&S®FPL1-B31), the R&S®ZNL is a fully portable instrument ideal for field use.

The optional 12 V/24 V DC power supply (R&S®FPL1-B30) is available for operation of the R&S®ZNL in vehicles.

Accessories for transport and field use

For transport and field deployment of the R&S®ZNL, the optional R&S®FPL1-Z2 transport bag protects the instrument against damage and the ingress of dirt. Side vents and a transparent top cover allow portable operation while the instrument is safely stored in the bag. A carrying vest holster (R&S®FPL1-Z3 option) is also available.

For outdoor use in challenging light conditions, the instrument display can be equipped with an anti-glare film (R&S®FPL1-Z5 option). This improves the contrast of the display and protects the screen against scratches.

The R&S®ZNL can be stowed and carried in a robust transport bag.



Rear view of the R&S®ZNL with battery compartment. The batteries can be easily accessed.



Specifications

Measurement range

Impedance		50 Ω
Test port connector		N female
Number of test ports		2
Frequency range ¹	R&S®ZNL3	5 kHz to 3 GHz
	R&S®ZNL4	5 kHz to 4.5 GHz
	R&S®ZNL6	5 kHz to 6 GHz

Static frequency accuracy		(time since last adjustment × aging rate) + temperature drift + calibration accuracy
Aging per year	standard	$\pm 1 \times 10^{-6}$
	with R&S®FPL-B4 precision frequency reference option	$\pm 1 \times 10^{-7}$
Temperature drift (+5 °C to +40 °C)	standard	$\pm 1 \times 10^{-6}$
	with R&S®FPL-B4 precision frequency reference option	$\pm 1 \times 10^{-8}$
Achievable initial calibration accuracy	standard	$\pm 5 \times 10^{-7}$
	with R&S®FPL-B4 precision frequency reference option	$\pm 5 \times 10^{-8}$

Frequency resolution		1 Hz
Number of measurement points	per trace	1 to 100 001
Measurement bandwidth	1/1.5/2/3/5/7 steps	1 Hz to 500 kHz

Dynamic range ^{1, 2}		specification	typical
		5 kHz to 100 kHz	> 85 dB
100 kHz to 10 MHz	> 100 dB	120 dB	
10 MHz to 50 MHz	> 110 dB	120 dB	
50 MHz to 4.5 GHz	> 120 dB	130 dB	
4.5 GHz to 6 GHz	> 115 dB	125 dB	

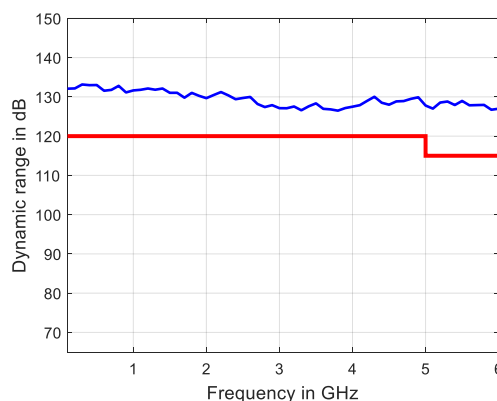
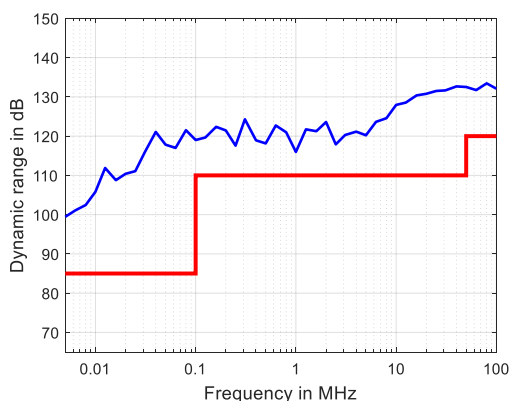

Dynamic range in dB versus frequency for the R&S®ZNL

¹ Specified and typical data given in this data sheet applies to the R&S®ZNL3, R&S®ZNL4 and R&S®ZNL6; please note their respective frequency ranges.

² The dynamic range is defined as the difference between 0 dBm source power and the RMS value of the data trace of the transmission magnitude, which is produced by noise and crosstalk with the test ports short-circuited. The specification applies at 10 Hz measurement bandwidth, without system error correction. The dynamic range can be increased by using a measurement bandwidth of 1 Hz.

Measurement speed

Measured with firmware version 1.00 and Windows 10, 64 bit.

Measurement time	for 201 measurements points, with 200 MHz span, 500 kHz measurement bandwidth	T_{SWEEP}	T_{CYCLE}	
	with 900 MHz center frequency	< 4.0 ms	< 5.0 ms	
Acquisition time per point (T_{ACQ})	500 kHz measurement bandwidth, CW mode	< 10 μ s		
Sampling time per point (T_{SAMPLE}) IF filter: normal	at 500 kHz measurement bandwidth	4.5 μ s		
Time for measurement and data transfer	for 201 measurements points, with 800 MHz start frequency, 1 GHz stop frequency, 500 kHz measurement bandwidth ³	IEC/IEEE	VXI11	HiSLIP
		meas. 10 ms	over 1 Gbit/s LAN	
Data transfer time	for 201 measurements points (magnitude)	meas. 3 ms	meas. 2.5 ms	meas. 2.5 ms
Switching time between channels	with a maximum of 2001 points	< 5 ms		
Switching time between two preloaded instrument settings	with a maximum of 2001 points	< 5 ms		

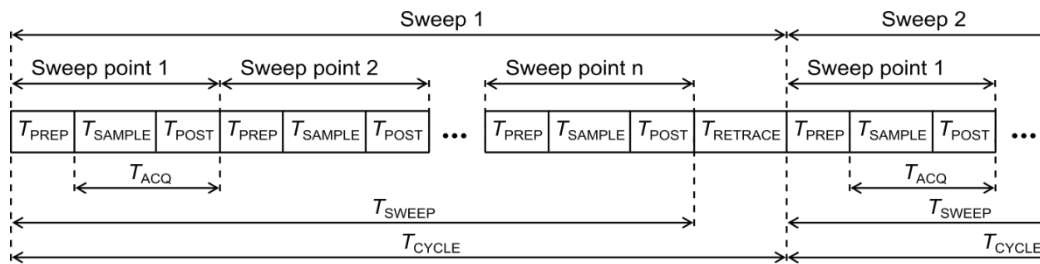

- T_{PREP} Preparation time required to set up the internal hardware components
- T_{SAMPLE} Sampling time (approximately equal to the settling time of the digital filters)
- T_{POST} Time required for hardware postprocessing
- T_{ACQ} Acquisition time ($T_{SAMPLE} + T_{POST}$)
- T_{SWEEP} Time required for one sweep
- $T_{RETRACE}$ Time between two sweeps
- T_{CYCLE} Sweep cycle time ($T_{SWEEP} + T_{RETRACE}$)

Measurement sequence

Typical sweep times versus number of measurement points ^{1, 4}					
Number of measurement points	51	201	401	1601	5001
800 MHz start frequency, 1 GHz stop frequency, 100 kHz measurement bandwidth					
With correction switched off	2.4 ms	4.9 ms	8.7 ms	31.2 ms	94 ms
With 2-port TOSM calibration	3.9 ms	9.6 ms	16.7 ms	61.7 ms	189 ms
800 MHz start frequency, 1 GHz stop frequency, 1 kHz measurement bandwidth					
With correction switched off	66 ms	258 ms	515 ms	2055 ms	6400 ms
With 2-port TOSM calibration	132 ms	515 ms	1028 ms	4100 ms	12780 ms
100 MHz start frequency, 3 GHz stop frequency, 100 kHz measurement bandwidth					
With correction switched off	3.9 ms	9.1 ms	14.5 ms	36.7 ms	102 ms
With 2-port TOSM calibration	7.3 ms	17.7 ms	28.8 ms	73.3 ms	206 ms
100 MHz start frequency, 3 GHz stop frequency, 1 kHz measurement bandwidth					
With correction switched off	68 ms	262 ms	519 ms	2055 ms	6390 ms
With 2-port TOSM calibration	136 ms	524 ms	1040 ms	4110 ms	12800 ms
100 MHz start frequency, 6 GHz stop frequency, 100 kHz measurement bandwidth					
With correction switched off	3.9 ms	9.5 ms	15.4 ms	47 ms	104 ms
With 2-port TOSM calibration	7.3 ms	18.8 ms	30.5 ms	95 ms	209 ms
100 MHz start frequency, 6 GHz stop frequency, 1 kHz measurement bandwidth					
With correction switched off	68 ms	263 ms	521 ms	2070 ms	6400 ms
With 2-port TOSM calibration	136 ms	525 ms	1042 ms	4120 ms	12800 ms

³ In continuous mode, no additional time for data transfer is needed as this occurs simultaneously during the measurement.

⁴ Sweep time is to be understood as cycle time; static frequency accuracy of the instrument applies; measured with firmware version 1.00, Windows 10.

Measurement accuracy

This data is valid between +18 °C and +28 °C, provided the temperature has not varied by more than 1 °C since calibration. Validity of the data is conditional on the use of an R&S®ZV-Z270 calibration kit and TOSM/SOLT calibration. This calibration kit is used to achieve the effective system data specified below. Frequency points, measurement bandwidth and sweep time have to be identical for measurement and calibration (no interpolation allowed).

Accuracy of transmission measurements		
Above 5 kHz	+5 dB to -35 dB	< 0.05 dB or < 0.5°
	-35 dB to -50 dB	< 0.1 dB or < 1°
	-50 dB to -65 dB	< 0.2 dB or < 2°
Specifications are based on a matched DUT, a measurement bandwidth of 10 Hz and a nominal source power of -10 dBm.		

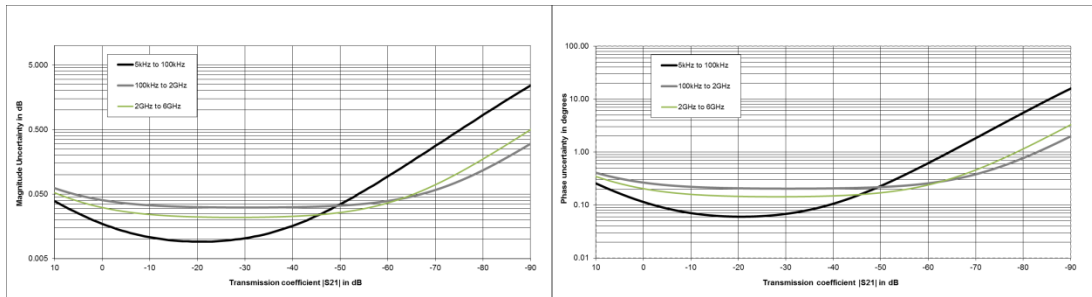

Typical accuracy of transmission magnitude and transmission phase measurements for the R&S®ZNL 1; analysis conditions: $S_{11} = S_{22} = 0$, calibrated power -10 dBm, measured power -10 dBm

Accuracy of reflection measurements	logarithmic			linear	
		magnitude	phase		magnitude
100 kHz to 2 GHz	0 dB	≤ 0.12 dB	≤ 0.8°	0 dB to -3 dB	0.014
	-3 dB	≤ 0.12 dB	≤ 0.8°	< -3 dB to -6 dB	0.009
	-6 dB	≤ 0.12 dB	≤ 0.8°	< -6 dB to -15 dB	0.007
	-15 dB	≤ 0.30 dB	≤ 2.0°	< -15 dB to -25 dB	0.006
	-25 dB	≤ 0.90 dB	≤ 6.0°	< -25 dB to -35 dB	0.006
2 GHz to 6 GHz	0 dB	≤ 0.20 dB	≤ 1.3°	0 dB to -3 dB	0.024
	-3 dB	≤ 0.20 dB	≤ 1.3°	< -3 dB to -6 dB	0.016
	-6 dB	≤ 0.23 dB	≤ 1.5°	< -6 dB to -15 dB	0.013
	-15 dB	≤ 0.60 dB	≤ 4.0°	< -15 dB to -25 dB	0.012
	-25 dB	≤ 1.70 dB	≤ 13°	< -25 dB to -35 dB	0.012
	-35 dB	≤ 4.50 dB	≤ 42°		

Specifications are based on an isolating DUT, a measurement bandwidth of 10 Hz and a nominal source power of -10 dBm.

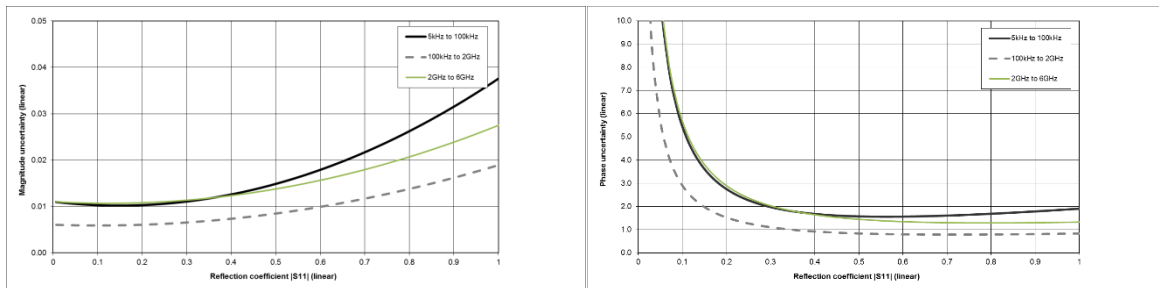

Typical accuracy of reflection magnitude and reflection phase measurements for the R&S®ZNL 1; analysis conditions: $S_{12} = S_{21} = 0$, calibrated power -10 dBm, measured power -10 dBm

Effective system data

This data is valid between +18 °C and +28 °C, provided the temperature has not varied by more than 1 °C after calibration. Frequency points, measurement bandwidth and sweep time have to be identical for measurement and calibration (no interpolation allowed). The data is based on a measurement bandwidth of 10 Hz and system error calibration using TOSM/SOLT with an R&S®ZV-Z270 calibration kit.

R&S®ZNL	100 kHz to 2 GHz	>2 GHz to 6 GHz
Directivity	≥ 46 dB	≥ 40 dB
Source match	≥ 40 dB	≥ 36 dB
Load match	≥ 46 dB	≥ 40 dB
Reflection tracking	≤ 0.03 dB	≤ 0.05 dB
Transmission tracking	≤ 0.03 dB	≤ 0.05 dB

Factory-calibrated system data

This data is valid between +18 °C and +28 °C. It is based on a source power of -10 dBm and a measurement bandwidth of 1 kHz.

		specification	typical
Directivity	100 kHz to 6 GHz	≥ 20 dB	35 dB
Source match	100 kHz to 6 GHz	≥ 20 dB	35 dB
Reflection tracking	100 kHz to 6 GHz	≤ 1 dB	0.1 dB
Transmission tracking	100 kHz to 3 GHz	≤ 1 dB	0.1 dB
Transmission tracking	3 GHz to 6 GHz	≤ 1.5 dB	0.2 dB
Load match (raw testport match)	100 kHz to 3 GHz	≥ 14 dB	20 dB
Load match (raw testport match)	3 GHz to 6 GHz	≥ 12 dB	16 dB

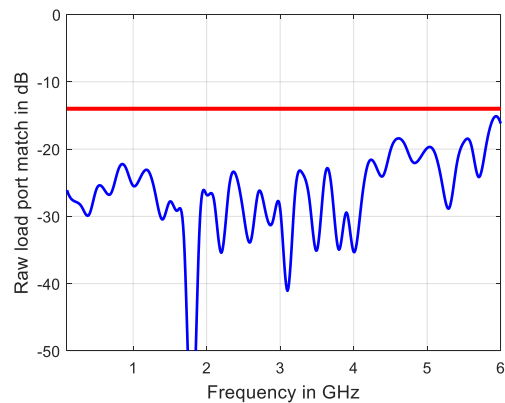
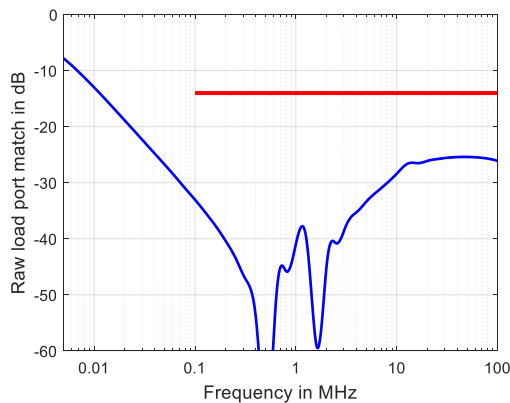

Raw load port match versus frequency for the R&S®ZNL

Trace stability		specification	typical
Trace noise magnitude (RMS)	at 0 dBm source power, 0 dB reflection	IF bandwidth	
	100 kHz to 10 MHz	10 kHz	< 0.0035 dB
	10 MHz to 6 GHz	10 kHz	< 0.0025 dB
Trace noise phase (RMS)	at 0 dBm source power, 0 dB reflection	IF bandwidth	
	100 kHz to 10 MHz	10 kHz	< 0.05
	10 MHz to 6 GHz	10 kHz	< 0.03
Temperature dependence	at 0 dB transmission or reflection		
	100 kHz to 6 GHz	magnitude	0.03 dB/K
		phase	0.8°/K

Test port output

This data is valid from +18 °C to +28 °C.

		specification	typical
Power range of the R&S®ZNL ¹	without R&S®ZNL-B22 extended power range option ¹		
	5 kHz to 100 kHz	-10 dBm to -3 dBm	up to +3 dBm
	100 kHz to 6 GHz	-10 dBm to 0 dBm	up to +3 dBm
	with R&S®ZNL-B22 extended power range option ¹		
Power accuracy of the R&S®ZNL ¹	5 kHz to 100 kHz	-40 dBm to -3 dBm	up to +3 dBm
	100 kHz to 6 GHz	-40 dBm to 0 dBm	up to +3 dBm
Power accuracy of the R&S®ZNL ¹	source power -10 dBm		
	5 kHz to 100 kHz	≤ 3 dB	
Power linearity	100 kHz to 6 GHz	≤ 2 dB	0.5 dB
	referenced to -10 dBm		
Power resolution	100 kHz to 6 GHz	≤ 1 dB	0.25 dB
		0.01 dB	
Harmonics	source power -10 dBm		
	100 kHz to 6 GHz	≤ -25 dBc	-40 dBc

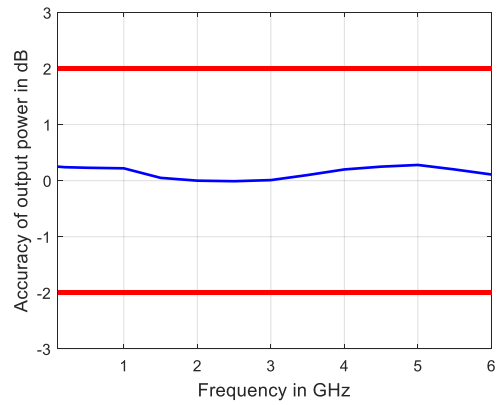
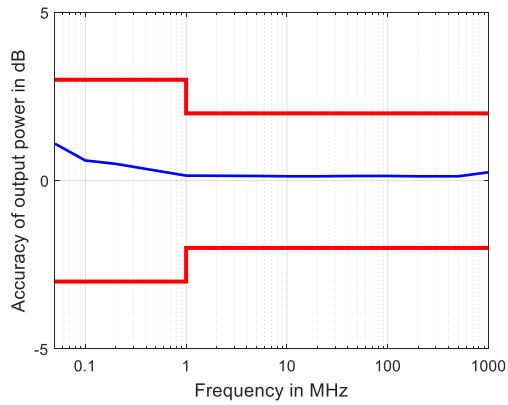

Output power accuracy in dB versus frequency for the R&S®ZNL base unit

Test port input

		specification	typical
Maximum nominal input level		0 dBm	
Power measurement accuracy	at -10 dBm without power calibration		
	9 kHz to 100 kHz	≤ 2 dB	0.3 dB
	100 kHz to 6 GHz	≤ 1.5 dB	0.3 dB
Receiver linearity referenced to -10 dBm	+10 dB to +5 dB	≤ 0.25 dB	0.1 dB
	+5 dB to -40 dB	≤ 0.15 dB	0.05 dB
Damage level		+27 dBm	
Damage DC voltage		30 V	
Noise level at 1 kHz measurement bandwidth, normalized to 1 Hz	5 kHz to 100 kHz	< -95 dBm (1 Hz)	-120 dBm (1 Hz)
	100 kHz to 50 MHz	< -120 dBm (1 Hz)	-130 dBm (1 Hz)
	50 MHz to 4.5 GHz	< -130 dBm (1 Hz)	-140 dBm (1 Hz)
	4.5 GHz to 6 GHz	< -125 dBm (1 Hz)	-135 dBm (1 Hz)

The noise level is defined as the RMS value of the specified noise floor.

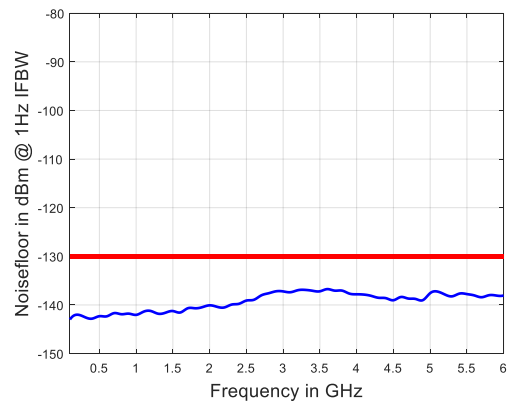
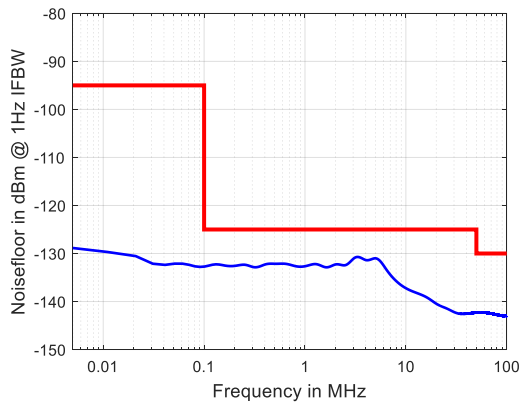

Noise level in dBm (1 Hz) versus frequency for the R&S®ZNL

Display

Screen	26.4 cm (10.1") diagonal WXGA color LCD with touchscreen
Resolution	1280 × 800 × 262144 (high color, 125 dpi)
Pixel failure rate	$< 1 \times 10^{-5}$

Front panel connectors

USB	two universal serial bus connectors for connecting USB devices (USB 2.0); two additional USB 3.0 connectors on rear panel
-----	--

Rear panel connectors

LAN	local area network connector, 10/100/1000BASE-T, 8-pin, RJ-45
-----	---

USB	two universal serial bus connectors for connecting USB devices (USB 3.0); two additional USB 2.0 connectors on front panel
-----	---

MONITOR	DVI-D connector (for external monitor)
---------	--

REF IN	input for external frequency reference signal	
Connector type		BNC, female
Input frequency		10 MHz
Maximum permissible deviation		1 kHz
Input power		-10 dBm to +15 dBm at 50 Ω
Input impedance		> 10 kΩ

REF OUT	output for external frequency reference signal	
Connector type		BNC, female
Output frequency		10 MHz
Output frequency accuracy		80 Hz
Output power		+6 dBm ± 4 dB at 50 Ω

EXT TRIG IN	trigger input for analyzer	
Connector type		BNC, female
TTL signal (edge-triggered or level-triggered)		3 V, 5 V tolerant
Polarity (selectable)		positive or negative
Minimum pulse width		1 μs
Input impedance		> 10 kΩ

Options

R&S®ZNL3-B1, R&S®ZNL4-B1 and R&S®ZNL6-B1 spectrum analysis

Input

RF input		
Impedance		50 Ω
Connector		N female
VSWR	10 MHz ≤ f ≤ 3 GHz	< 1.5 (nom.)
	3 GHz < f ≤ 6 GHz	< 1.7 (nom.)
Setting range of attenuator		0 dB to 30 dB, in 10 dB steps

Frequency

Frequency range	R&S®ZNL3-B1	5 kHz to 3 GHz
	R&S®ZNL4-B1	5 kHz to 4.5 GHz
	R&S®ZNL6-B1	5 kHz to 6 GHz
Frequency resolution		0.01 Hz

Reference frequency, internal	see section: Measurement range
-------------------------------	--------------------------------

Frequency readout		
Marker resolution		0.01 Hz
Uncertainty		±(marker frequency × reference uncertainty + 10 % × resolution bandwidth + ½ (span/(sweep points – 1)) + 1 Hz)
Number of sweep (trace) points	default value	1001
	range	101 to 100001
Marker tuning frequency step size	marker step size = sweep points	span/(sweep points – 1)
	marker step size = standard	span/(default sweep points – 1)
Frequency counter resolution		1 Hz
Count accuracy		±(frequency × reference uncertainty + ½ (last digit))
Display range for frequency axis		0 Hz, 10 Hz to max. frequency
Resolution		0.1 Hz
Maximum span deviation		0.1 %

Spectral purity SSB phase noise	frequency = 1000 MHz, carrier offset	specification	typical	nominal
	100 Hz			
1 kHz				-107 dBc (1 Hz)
10 kHz		< -103 dBc (1 Hz)	-108 dBc (1 Hz)	
100 kHz		< -110 dBc (1 Hz)	-115 dBc (1 Hz)	
1 MHz		< -128 dBc (1 Hz)	-133 dBc (1 Hz)	
10 MHz				-153 dBc (1 Hz)

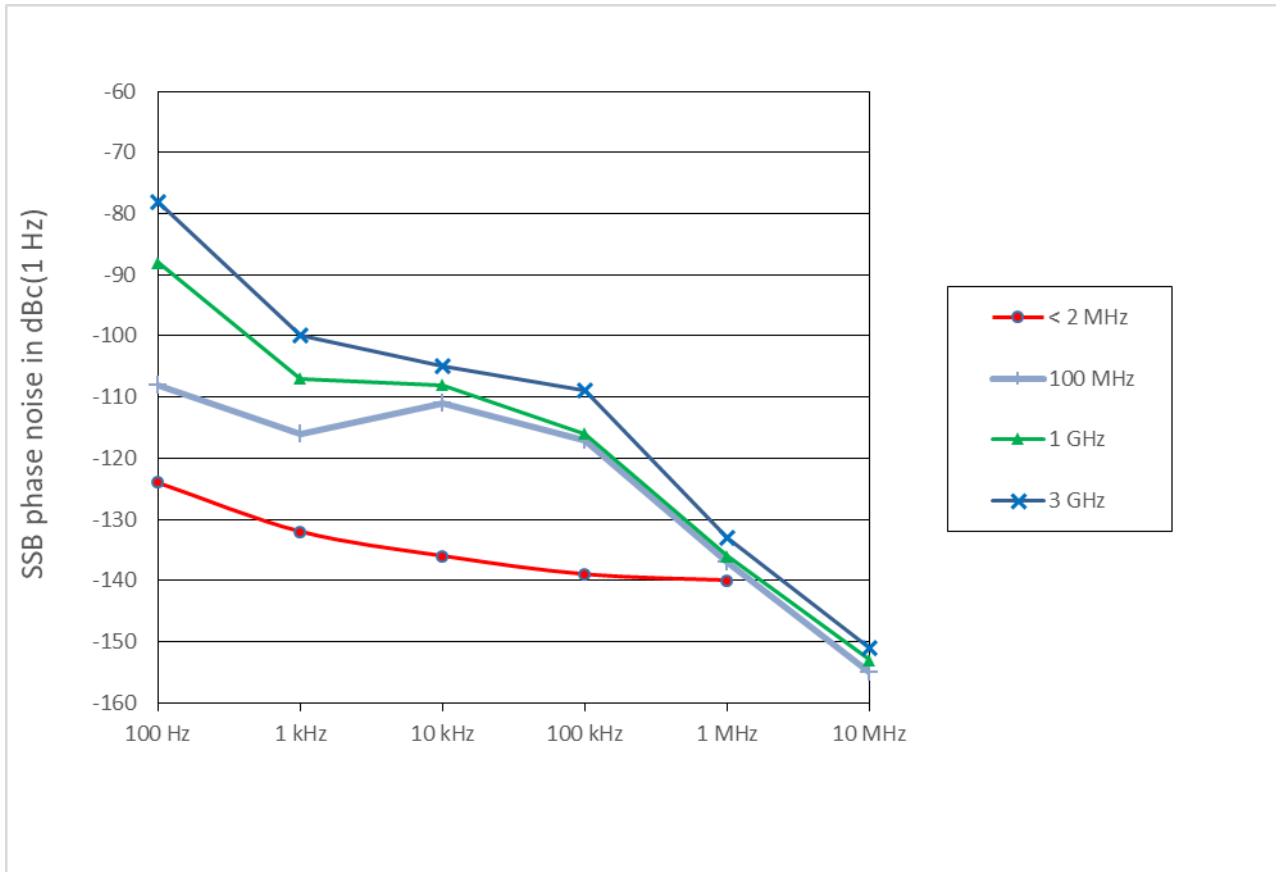

Typical phase noise at different center frequencies

Sweep time

Range	span = 0 Hz	1 μ s to 8000 s
	span \geq 10 Hz, RBW \geq 100 kHz	1 ms to 8000 s ⁵
	span \geq 10 Hz, RBW < 100 kHz	75 μ s to 8000 s ⁶
Sweep time accuracy	span = 0 Hz	0.1 % (nom.)
	span \geq 10 Hz, RBW \geq 100 kHz	3 % (nom.)

Resolution bandwidths

Sweep filters and FFT filters		
Resolution bandwidths (-3 dB)	sweep filters	100 kHz to 10 MHz in 1/2/3/5 sequence
	FFT filters	1 Hz to 50 kHz in 1/2/3/5 sequence
Bandwidth uncertainty		< 3 % (nom.)
Shape factor 60 dB:3 dB		< 5 (nom.)

⁵ Net sweep time without additional hardware settling time.

⁶ Time for data acquisition for FFT calculation.

Channel filters		
Bandwidths (-3 dB)		100 Hz, 200 Hz, 300 Hz, 500 Hz 1/1.5/2/2.4/2.7/3/3.4/4/4.5/5/6/7.5/8.5/9/ 10/12.5/14/15/16/20/21/25/30/50/ 100/150/192/200/300/500 kHz 1/1.228/1.5/2/3/3.75/5/10 MHz
Bandwidth uncertainty		< 2 % (nom.)
Shape factor 60 dB:3 dB		< 2 (nom.)

Video bandwidths	standard	1 Hz to 10 MHz in 1/2/3/5 sequence
-------------------------	----------	------------------------------------

Signal analysis bandwidth (equalized)	standard	10 MHz (nom.)
	with R&S®FPL1-B40 option	40 MHz (nom.)

Level

Display range		displayed noise floor up to +30 dBm
---------------	--	-------------------------------------

Intermodulation		
Third order intercept point (TOI)	RF attenuation 0 dB, level 2×-20 dBm, $\Delta f > 5 \times$ RBW or 10 kHz, whichever is larger	
	$10 \text{ MHz} \leq f_{in} < 300 \text{ MHz}$	> 13 dBm, 20 dBm (typ.)
	$300 \text{ MHz} \leq f_{in} < 3 \text{ GHz}$	> 16 dBm, 22 dBm (typ.)
	$3 \text{ GHz} \leq f_{in} < 6 \text{ GHz}$	> 13 dBm, 18 dBm (typ.)
Second harmonic intercept (SHI)	RF attenuation 0 dB, level -13 dBm	
	$1 \text{ MHz} < f_{in} \leq 900 \text{ MHz}$	45 dBm (nom.)
	$900 \text{ MHz} < f_{in} \leq 1.5 \text{ GHz}$	70 dBm (nom.)

Displayed average noise level (DANL)		
termination 50 Ω , log. scaling, normalized to 1 Hz RBW, RBW = 1 kHz, VBW = 1 Hz, sample detector, +18 °C to +28 °C		
RF attenuation 0 dB	$5 \text{ kHz} \leq f < 100 \text{ kHz}$	-130 dBm (typ.)
	$100 \text{ kHz} \leq f < 5 \text{ MHz}$	< -135 dBm, -145 dBm (typ.)
	$5 \text{ MHz} \leq f < 4.5 \text{ GHz}$	< -140 dBm, -150 dBm (typ.)
	$4.5 \text{ GHz} \leq f < 6 \text{ GHz}$	< -137 dBm, -147 dBm (typ.)

Spurious responses	RF attenuation 0 dB, sweep optimization: auto or dynamic	
Image response	$10 \text{ MHz} \leq f \leq 3 \text{ GHz}$	
	$f_{in} - 2 \times 4020.4 \text{ MHz}$ (1st IF)	< -90 dBc (nom.)
	$f_{in} - 2 \times 820.4 \text{ MHz}$ (2nd IF)	< -80 dBc
	$f_{in} - 2 \times 20.4 \text{ MHz}$ (3rd IF), RBW $\leq 5 \text{ MHz}$	< -80 dBc
	$3 \text{ GHz} < f \leq 6 \text{ GHz}$	< -70 dBc (nom.)
Intermediate frequency response	$2 \text{ MHz} \leq f \leq 3 \text{ GHz}$	
	1st IF (4020.4 MHz)	< -80 dBc (nom.)
	2nd IF (820.4 MHz)	< -80 dBc
	3rd IF (20.4 MHz)	< -80 dBc
	$3 \text{ GHz} < f \leq 6 \text{ GHz}$	< -70 dBc (nom.)
Residual spurious response	RF attenuation 0 dB,	
	$f \leq 1 \text{ MHz}$	< -90 dBm (nom.)
	$f > 1 \text{ MHz}$	< -90 dBm
Local oscillator related spurious	$f < 3 \text{ GHz}$, RF attenuation 10 dB, RF input -10 dBm	
	$1 \text{ kHz} \leq$ carrier offset $\leq 10 \text{ MHz}$	< -70 dBc (nom.)
	carrier offset $> 10 \text{ MHz}$	< -80 dBc (nom.)
	$3 \text{ GHz} < f \leq 6 \text{ GHz}$	< -70 dBc (nom.)
Other interfering signals		
Subharmonic of 1st LO	$20 \text{ MHz} \leq f < 3 \text{ GHz}$, spurious at $4020.4 \text{ MHz} - 2 \times f_{in}$	< -80 dBc (nom.)
Harmonic of 1st LO	mixer level $< -25 \text{ dBm}$, spurious at $f_{in} - 2010.2 \text{ MHz}$	< -80 dBc (nom.)

Level display		
Logarithmic level axis		1 dB to 200 dB, in 1 dB steps
Linear level axis		10 % of reference level per level division, 10 divisions or logarithmic scaling
Number of traces		6
Trace detector		Max. peak, min. peak, auto peak (normal), sample, RMS, average
Trace functions		clear/write, max. hold, min. hold, average, view
Setting range of reference level		-130 dBm to (-10 dBm + RF attenuation) in steps of 0.01 dB
Units of level axis		dBm, dBμV, dBmV, dBμA, dBpW, V, A, W

Level measurement uncertainty		
Absolute level uncertainty at 50 MHz	RBW = 10 kHz, level -10 dBm, reference level -10 dBm, RF attenuation 10 dB	
	+18 °C to +28 °C	< 0.5 dB ($\sigma = 0.1$ dB)
	+5 °C to +40 °C	< 1 dB ($\sigma = 0.17$ dB)
R&S®ZNL3	RF attenuation 0 dB, 10 dB, 20 dB, 30 dB, +18 °C to +28 °C	
Frequency response referenced to 50 MHz	5 kHz ≤ f ≤ 3 MHz	< 1 dB (nom.)
	3 MHz < f ≤ 10 MHz	< 0.8 dB (nom.)
	10 MHz < f ≤ 3 GHz	< 0.8 dB ($\sigma = 0.1$ dB)
R&S®ZNL4 and R&S®ZNL6	RF attenuation 0 dB, 10 dB, 20 dB, 30 dB, +18 °C to +28 °C	
Frequency response referenced to 50 MHz	5 kHz ≤ f ≤ 3 MHz	< 1 dB (nom.)
	3 MHz < f ≤ 10 MHz	< 0.8 dB (nom.)
	10 MHz < f ≤ 2.9 GHz	< 0.8 dB ($\sigma = 0.1$ dB)
	2.9 GHz < f ≤ 6 GHz	< 1.3 dB ($\sigma = 0.1$ dB)
Attenuator switching uncertainty	f = 50 MHz, 0 dB to 30 dB, referenced to 10 dB attenuation	< 0.3 dB ($\sigma = 0.07$ dB)
Uncertainty of reference level setting		0 dB ⁷
Bandwidth switching uncertainty	referenced to RBW = 10 kHz	
	RBW ≥ 1 MHz	< 0.3 dB (nom.)
	100 kHz ≤ RBW < 1 MHz	< 0.2 dB (nom.)
	RBW < 100 kHz	< 0.1 dB (nom.)

Nonlinearity of displayed level		
Logarithmic level display	S/N > 16 dB, 0 dB to -50 dB	< 0.2 dB ($\sigma = 0.07$ dB)
Linear level display	S/N > 16 dB, 0 dB to -70 dB	5 % of reference level (nom.)

Total measurement uncertainty		
	signal level 0 dB to -50 dB below reference level, S/N > 20 dB, sweep time auto, sweep type = sweep, RF attenuation 10 dB, 20 dB, 30 dB, span/RBW < 100, 95 % confidence level, +18 °C to +28 °C	
R&S®ZNL3	3 MHz < f ≤ 3 GHz	1 dB
R&S®ZNL4 and R&S®ZNL6	3 MHz < f ≤ 2.9 GHz	1 dB
	2.9 GHz < f ≤ 6 GHz	1.5 dB

Measurement speed

Local measurement and display update rate	1001 sweep points, sweep optimization set to "speed"	1 ms (1000/s) (nom.)
Max. sweep rate, remote operation ^{8,9}	trace average = on	0.9 ms (1100/s) (nom.)
Remote measurement and LAN transfer ⁸		2.8 ms (357/s) (nom.)
Marker peak search ⁸		1.3 ms (nom.)
Center frequency tune + sweep + sweep data transfer ⁸		15 ms (nom.)

⁷ The setting of the reference level affects only the graphical representation of the measurement result on the display, not the measurement itself. Therefore, the reference level setting causes no additional uncertainty in measurement results.

⁸ Measured with personal computer equipped with Intel® Core™ i7 2.8 GHz and Gbit LAN interface.

⁹ Measurement is performed with a sweep count of 1000. The indicated speed is the average speed of 1 sweep.

Trigger functions

Trigger		
Trigger source		free run, video, external, IF power
Trigger offset	span \geq 10 Hz	50 ns to 40 s, min. resolution 50 ns (or 0.5 % of offset)
	span = 0 Hz	(–sweep time) to 40 s, min. resolution 50 ns (or 0.5 % of offset)
Maximum deviation of trigger offset		$\pm(7.8125 \text{ ns} + (0.1 \% \times \text{trigger offset}))$
IF power trigger		
Sensitivity	min. signal power	–60 dBm + RF attenuation
	max. signal power	–15 dBm + RF attenuation
IF power trigger bandwidth	RBW > 5 MHz	40 MHz (nom.)
	RBW \leq 5 MHz	6 MHz (nom.)
Gated sweep		
Gate source		video, external, IF power
Gate delay		50 ns to 30 s, min. resolution 50 ns (or 0.5 % of delay)
Gate length		125 ns to 30 s, min. resolution 50 ns (or 0.5 % of gate length)
Maximum deviation of gate length		$\pm(7.8125 \text{ ns} + (0.1 \% \times \text{gate length}))$

I/Q data

Interface		GPIB or LAN interface
Memory length		max. 25 Msample I and Q
Word length of I/Q samples		14 bit
Sampling rate	standard	100 Hz to 45 MHz
	with R&S®FPL-B40 option	100 Hz to 100 MHz
Maximum signal analysis bandwidth (equalized)	standard	10 MHz
	with R&S®FPL-B40 option	40 MHz
Signal analysis bandwidth \leq 10 MHz		
Amplitude flatness		$\pm 0.3 \text{ dB}$ (nom.)
Deviation from linear phase		$\pm 1^\circ$ (nom.)
Signal analysis bandwidth \leq 40 MHz		
Amplitude flatness		$\pm 0.5 \text{ dB}$ (nom.)
Deviation from linear phase		$\pm 1.5^\circ$ (nom.)

R&S®ZNL3-B22, R&S®ZNL4-B22 and R&S®ZNL6-B22 extended power range

Extended power range		specification	typical
Frequency range	R&S®ZNL3-B22	5 kHz to 3 GHz	
	R&S®ZNL4-B22	5 kHz to 4.5 GHz	
	R&S®ZNL6-B22	5 kHz to 6 GHz	
Power range for the R&S®ZNL ¹	5 kHz to 50 kHz	–40 dBm to –3 dBm	up to +3 dBm
	50 kHz to 6 GHz	–40 dBm to +0 dBm	up to +3 dBm

R&S®ZNL3-B31/-B32, R&S®ZNL4-B31/-B32 and R&S®ZNL6-B31/-B32 receiver step attenuators

Receiver step attenuators		
Frequency range	R&S®ZNL3-B31/R&S®ZNL3-B32	5 kHz to 3 GHz
	R&S®ZNL4-B31/R&S®ZNL4-B32	5 kHz to 4.5 GHz
	R&S®ZNL6-B31/R&S®ZNL6-B32	5 kHz to 6 GHz
Attenuation		0 dB to 30 dB in 10 dB steps

R&S®FPL1-B5 additional interfaces

User port		
Connector		25-pin D-Sub female
Output		TTL-compatible, 0 V/5 V, max. 15 mA
Input		TTL-compatible, max. 5 V

Noise source control		
Connector		BNC female
Output		0 V/28 V, max. 100 mA, switchable, supply for noise source

Power sensor		
Connector		6-pin LEMOSA female for supported R&S®NRP-Zxx power sensors

IF/video/demod out		
Connector		BNC female, 50 Ω
IF out		
Bandwidth		equal to RBW setting
IF frequency		25 MHz
Output level	center frequency > 10 MHz, span = 0 Hz, signal at reference level and center frequency	0 dBm (nom.)
Video out		
Bandwidth		equal to VBW setting
Output scaling	log. display scale lin. display scale	logarithmic linear
Output level	center frequency > 10 MHz, span = 0 Hz, signal at reference level and center frequency	1 V (nom.), open circuit

Audio output		
Loudspeaker		built-in, adjustable
AF out		
Connector		3.5 mm mini jack
Output impedance		10 Ω
Open-circuit voltage		up to 1.5 V, adjustable

R&S®FPL1-B4 precision frequency reference (OCXO)

Static frequency accuracy		(time since last adjustment × aging rate) + temperature drift + calibration accuracy
Aging per year	with R&S®FPL-B4 precision frequency reference option	$\pm 1 \times 10^{-7}$
Temperature drift (+5 °C to +40 °C)	with R&S® FPL-B4 precision frequency reference option	$\pm 1 \times 10^{-8}$
Achievable initial calibration accuracy	with R&S® FPL-B4 precision frequency reference option	$\pm 5 \times 10^{-8}$

R&S®FPL1-B10 GPIB interface

GPIB interface	remote control interface in line with IEEE 488, IEC 60625; 24-pin
-----------------------	---

R&S®FPL1-B30 DC power input 12 V/24 V

Input voltage range		10.4 V to 28 V, switch-on voltage > 11 V
Input current	$V_{in} = 12\text{ V/24 V}$, operating mode, without internal batteries (R&S®FPL1-B31)	5.5 A/2.7 A (nom.)
	$V_{in} = 12\text{ V/24 V}$, operating mode, internal batteries in charge mode	11 A/5 A (nom.)
	$V_{in} = 12\text{ V/24 V}$, instrument standby mode, internal batteries in charge mode	6.5 A/3 A (nom.)
Temperature	operating temperature range	+5 °C to +40 °C
	storage temperature range	-20 °C to +70 °C

R&S®FPL1-B31 internal lithium-ion battery

Operating time		3.5 h (nom.)
Charge time	standby mode, AC supply	< 2 h (nom.)
	standby mode, external DC supply (R&S®FPL1-B30)	< 2 h (nom.)
	operating mode	< 4 h (nom.)
Temperature	operating temperature	+5 °C to +40 °C
	storage temperature range	-20 °C to +60 °C ¹⁰

R&S®FSV-B34 charger (only necessary to charge spare batteries)

AC input voltage range		100 V to 240 V, ±10 % (nom.)
AC supply frequency		50 Hz to 60 Hz (nom.)
Power consumption		max. 300 W (nom.)
Number of charger bays		4
Dimensions	W × H × D	400 mm × 127 mm × 203 mm (15.75 in × 5 in × 8 in)
Net weight		3.1 kg (6.9 lb)

¹⁰ The battery packs should be stored in an environment with low humidity, free from corrosive gas at a recommended temperature range < +21 °C. Extended exposure to temperatures above +40°C could degrade battery performance and life.

General data

Data storage		
Internal	standard	solid-state drive 32 Gbyte (nom.)
External		supports USB-2.0-compatible memory devices

Environmental conditions		
Temperature	operating temperature range	+5 °C to +40 °C
	storage temperature range	–20 °C to +70 °C
Climatic loading		+40 °C at 85 % rel. humidity, in line with EN 60068-2-30, without condensation

Mechanical resistance		
Vibration	sinusoidal	5 Hz to 55 Hz 0.15 mm constant amplitude (1.8 g at 55 Hz); 55 Hz to 150 Hz acceleration: 0.5 g constant; in line with EN 60068-2-6
	random	10 Hz to 300 Hz, acceleration 1.2 g (RMS); in line with EN 60068-2-64
Shock		40 g shock spectrum; in line with MIL-STD-810E method No. 516.4 procedure I, MIL-PRF-28800F

EMC		in line with EMC Directive 2014/30/EU including IEC/EN 61326-1 ^{11, 12} , IEC/EN 61326-2-1, CISPR 11/EN 55011 ¹¹ , IEC/EN 61000-3-2, IEC/EN 61000-3-3
-----	--	---

Recommended calibration interval		1 year
----------------------------------	--	--------

Power supply		
AC supply	without battery option	100 V to 240 V ± 10 %, 50 Hz to 60 Hz ± 5 %, 400 Hz ± 5% class of protection I; in line with VDE 411
	with battery option	100 V to 240 V ± 10 %, 50 Hz to 60 Hz ± 5 %
Current consumption	without options	1.7 A to 0.8 A
	with internal battery (R&S®FPL1-B31 option) in charge mode	3 A to 1.5 A
Power consumption		max. 300 W, 90 W (typ.)
Safety		in line with EN 61010-1, IEC 61010-1, UL 61010-1, CAN/CSA-C22.2 No. 61010-1
Test mark		CSA, CSA-NRTL

Dimensions and weight		
Dimensions	W x H x D	408 mm x 186 mm x 235 mm (16.06 in x 7.32 in x 9.25 in)
Net weight, nominal	without options	6 kg (13.22 lb)
	with internal battery	7.3 kg (16 lb)

¹¹ Emission limits for class A equipment.

¹² Immunity test requirement for industrial environment (EN 61326 table 2).

Dimensions (in mm)

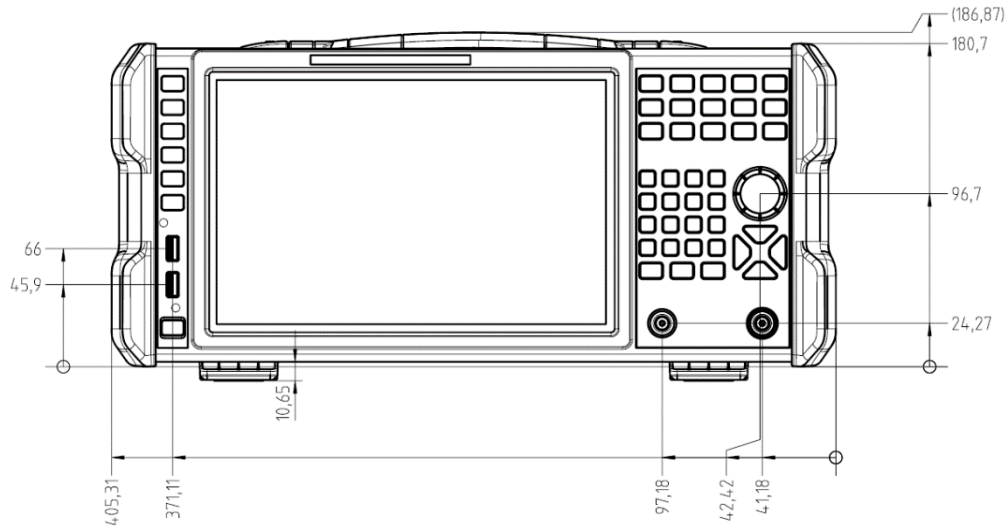

Front view of the R&S[®]ZNL

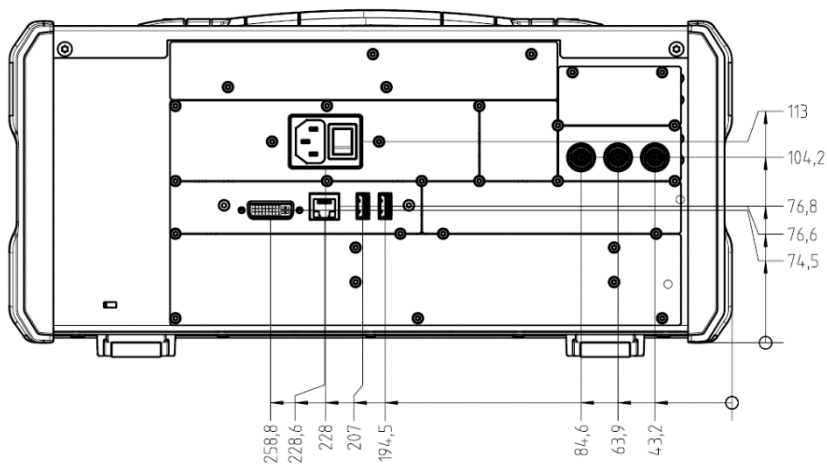

Rear view of the R&S[®]ZNL

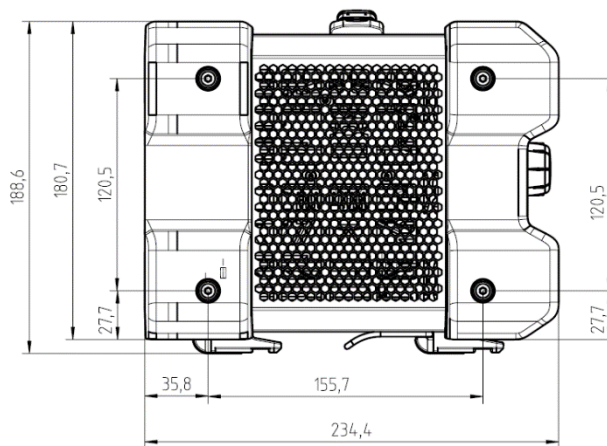

Side view of the R&S[®]ZNL

Ordering information

Designation	Type	Retrofit ¹³	On Site ¹⁴	Order No.
Base unit				
Vector network analyzer, two ports, 3 GHz, N	R&S [®] ZNL3			1323.0012K03
Vector network analyzer, two ports, 4.5 GHz, N	R&S [®] ZNL4			1323.0012K04
Vector network analyzer, two ports, 6 GHz, N	R&S [®] ZNL6			1323.0012K06
Options				
Spectrum analysis for R&S [®] ZNL3	R&S [®] ZNL3-B1	•		1323.1802.02
Spectrum analysis for R&S [®] ZNL4	R&S [®] ZNL4-B1	•		1303.8099.02
Spectrum analysis for R&S [®] ZNL6	R&S [®] ZNL6-B1	•		1323.2067.02
Extended power range				
Extended power range for two-port R&S [®] ZNL3	R&S [®] ZNL3-B22	•		1323.1860.02
Extended power range for two-port R&S [®] ZNL4	R&S [®] ZNL4-B22	•		1303.8118.02
Extended power range for two-port R&S [®] ZNL6	R&S [®] ZNL6-B22	•		1323.2021.02
Receiver step attenuators				
Receiver step attenuator, port 1, for R&S [®] ZNL3	R&S [®] ZNL3-B31	•		1323.1848.02
Receiver step attenuator, port 2, for R&S [®] ZNL3	R&S [®] ZNL3-B32	•		1323.1854.02
Receiver step attenuator, port 1, for R&S [®] ZNL4	R&S [®] ZNL4-B31	•		1303.8124.02
Receiver step attenuator, port 2, for R&S [®] ZNL4	R&S [®] ZNL4-B32	•		1303.8130.02
Receiver step attenuator, port 1, for R&S [®] ZNL6	R&S [®] ZNL6-B31	•		1323.2038.02
Receiver step attenuator, port 2, for R&S [®] ZNL6	R&S [®] ZNL6-B32	•		1323.2044.02
Precision frequency reference (OCXO)	R&S [®] FPL1-B4	•		1323.1902.02
Additional interface	R&S [®] FPL1-B5	•	•	1323.1883.02
GPIB interface	R&S [®] FPL1-B10	•	•	1323.1890.02
Second hard disk (SSD) Remark: mounted on PC board, including analyzer firmware	R&S [®] ZNL-B19	•	•	1323.2938.02
DC-power supply 12 V/24 V	R&S [®] FPL1-B30	•		1323.1877.02
Internal lithium-ion battery	R&S [®] FPL1-B31	•		1323.1725.02
40 MHz analysis bandwidth ¹⁵	R&S [®] FPL1-B40	•	•	1323.1931.02
Firmware/software				
Time domain analysis	R&S [®] ZNL-K2	•	•	1323.1819.02
Distance-to-fault measurement	R&S [®] ZNL-K3	•	•	1323.1825.02
AM/FM/φM measurement demodulator ¹⁵	R&S [®] FPL1-K7	•	•	1323.1731.02
Power sensor measurement with R&S [®] NRP power sensors ¹⁵	R&S [®] FPL1-K9	•	•	1323.1754.02
Noise figure and gain measurements ¹⁶	R&S [®] FPL1-K30	•	•	1323.1760.02

Recommended extras

Designation	Type	Order No.
Protective hard cover	R&S [®] FPL1-Z1	1323.1960.02
Soft carrying bag for transport and outdoor operation	R&S [®] FPL1-Z2	1323.1977.02
Carrying vest holster (requires R&S [®] FPL1-Z2)	R&S [®] FPL1-Z3	1323.1683.02
Spare lithium-ion battery pack ¹⁷	R&S [®] FPL1-Z4	1323.1677.02
Anti-glare display film for outdoor operation	R&S [®] FPL1-Z5	1323.1690.02
Lithium-ion battery charger for charging spare batteries ¹⁴	R&S [®] FSV-B34	1321.3950.02
19" rackmount kit	R&S [®] FPL1-Z6	1323.1954.02
Broadband limiter, N(m to f), 50 Ω, 50 MHz to 6 GHz	R&S [®] ZN-B13	1303.7840.02
Headphones		0708.9010.00
Matching pads, 50/75 Ω		
L section, matching at both ends	R&S [®] RAM	0358.5414.02
Series resistor, 25 Ω, matching at one end (taken into account in instrument function RF INPUT 75 Ω)	R&S [®] RAZ	0358.5714.02
Smart noise source		
Smart noise source for noise figure and gain measurements (requires R&S [®] FPL1-K30)	R&S [®] FS-SNS26	1338.8008.26

¹³ Option may also be ordered at a later stage, upgrade in service.

¹⁴ Option may be installed by the customer on site.

¹⁵ Requires R&S[®]ZNL3-B1, R&S[®]ZNL4-B1 or R&S[®]ZNL6-B1 spectrum analysis option.

¹⁶ Requires R&S[®]ZNL3-B1, R&S[®]ZNL4-B1 or R&S[®]ZNL6-B1 spectrum analysis option + R&S[®]FPL1-B5 additional interface.

¹⁷ Requires R&S[®]FPL1-B31 internal lithium-ion battery.

Designation	Type	Order No.
High-power attenuators		
Attenuator 100 W, 3/6/10/20/30 dB, 1 GHz	R&S®RBU100	1073.8495.xx (xx = 03/06/10/20/30)
Attenuator 50 W, 3/6/10/20/30 dB, 2 GHz	R&S®RBU50	1073.8695.xx (xx = 03/06/10/20/30)
Attenuator 50 W, 20 dB, 6 GHz	R&S®RDL50	1035.1700.52
Connectors and cables		
N-type adapter for R&S®RT-Zx probes	R&S®RT-ZA9	1417.0909.02
IEC/IEEE bus cable, length: 1 m	R&S®PCK	0292.2013.10
IEC/IEEE bus cable, length: 2 m	R&S®PCK	0292.2013.20
DC block		
DC block, 10 kHz to 18 GHz (type N)	R&S®FSE-Z4	1084.7443.02

Power sensors supported by the R&S®FPL1-K9 option ¹⁸

Designation	Type	Order No.
Universal power sensor, 10 MHz to 8 GHz, 200 mW	R&S®NRP-Z11	1138.3004.02
Universal power sensor, 10 MHz to 18 GHz, 200 mW	R&S®NRP-Z21	1137.6000.02
Universal power sensor, 10 MHz to 18 GHz, 2 W	R&S®NRP-Z22	1137.7506.02
Universal power sensor, 10 MHz to 18 GHz, 15 W	R&S®NRP-Z23	1137.8002.02
Universal power sensor, 10 MHz to 18 GHz, 30 W	R&S®NRP-Z24	1137.8502.02
Power sensor module with power splitter, DC to 18 GHz, 500 mW	R&S®NRP-Z27	1169.4102.02
Power sensor module with power splitter, DC to 26.5 GHz, 500 mW	R&S®NRP-Z37	1169.3206.02
Thermal power sensor, 0 Hz to 18 GHz, 100 mW	R&S®NRP-Z51	1138.0005.02
Thermal power sensor, 0 Hz to 40 GHz, 100 mW	R&S®NRP-Z55	1138.2008.02
Thermal power sensor, 0 Hz to 50 GHz, 100 mW	R&S®NRP-Z56	1171.8201.02
Thermal power sensor, 0 Hz to 67 GHz, 100 mW	R&S®NRP-Z57	1171.8401.02
Thermal power sensor, 0 Hz to 110 GHz, 100 mW	R&S®NRP-Z58	1173.7031.02
Wideband power sensor, 50 MHz to 18 GHz, 100 mW	R&S®NRP-Z81	1137.9009.02
Average power sensor, 9 kHz to 6 GHz, 200 mW	R&S®NRP-Z91	1168.8004.02
Average power sensor, 9 kHz to 6 GHz, 2 W	R&S®NRP-Z92	1171.7005.02
Two-path diode power sensor, 10 MHz to 8 GHz, 100 mW	R&S®NRP-Z211	1417.0409.02
Two-path diode power sensor, 10 MHz to 18 GHz, 100 mW	R&S®NRP-Z221	1417.0309.02
Three-path diode power sensor, 100 pW to 200 mW, 10 MHz to 8 GHz	R&S®NRP8S	1419.0006.02
Three-path diode power sensor, 100 pW to 200 mW, 10 MHz to 8 GHz, LAN version	R&S®NRP8SN	1419.0012.02
Three-path diode power sensor, 100 pW to 200 mW, 10 MHz to 18 GHz	R&S®NRP18S	1419.0029.02
Three-path diode power sensor, 100 pW to 200 mW, 10 MHz to 18 GHz, LAN version	R&S®NRP18SN	1419.0035.02
Three-path diode power sensor, 100 pW to 200 mW, 10 MHz to 33 GHz	R&S®NRP33S	1419.0064.02
Three-path diode power sensor, 100 pW to 200 mW, 10 MHz to 33 GHz, LAN version	R&S®NRP33SN	1419.0070.02

¹⁸ For average power measurement only.

Warranty		
Base unit		3 years
All other items ¹⁹		1 year
Options		
Extended warranty, one year	R&S [®] WE1	Please contact your local Rohde & Schwarz sales office.
Extended warranty, two years	R&S [®] WE2	
Extended warranty with calibration coverage, one year	R&S [®] CW1	
Extended warranty with calibration coverage, two years	R&S [®] CW2	
Extended warranty with accredited calibration coverage, one year	R&S [®] AW1	
Extended warranty with accredited calibration coverage, two years	R&S [®] AW2	

Extended warranty with a term of one and two years (WE1 and WE2)

Repairs carried out during the contract term are free of charge ²⁰. Necessary calibration and adjustments carried out during repairs are also covered.

Extended warranty with calibration coverage (CW1 and CW2)

Enhance your extended warranty by adding calibration coverage at a package price. This package ensures that your Rohde & Schwarz product is regularly calibrated, inspected and maintained during the term of the contract. It includes all repairs ²⁰ and calibration at the recommended intervals as well as any calibration carried out during repairs or option upgrades.

Extended warranty with accredited calibration (AW1 and AW2)

Enhance your extended warranty by adding accredited calibration coverage at a package price. This package ensures that your Rohde & Schwarz product is regularly calibrated under accreditation, inspected and maintained during the term of the contract. It includes all repairs ²⁰ and accredited calibration at the recommended intervals as well as any accredited calibration carried out during repairs or option upgrades.

¹⁹ For options that are installed, the remaining base unit warranty applies if longer than 1 year. Exception: all batteries have a 1 year warranty.

²⁰ Excluding defects caused by incorrect operation or handling and force majeure. Wear-and-tear parts are not included.

Service that adds value

- ▶ Worldwide
- ▶ Local und personalized
- ▶ Customized and flexible
- ▶ Uncompromising quality
- ▶ Long-term dependability

Rohde & Schwarz

The Rohde & Schwarz electronics group offers innovative solutions in the following business fields: test and measurement, broadcast and media, secure communications, cybersecurity, monitoring and network testing. Founded more than 80 years ago, the independent company which is headquartered in Munich, Germany, has an extensive sales and service network with locations in more than 70 countries.

www.rohde-schwarz.com

Sustainable product design

- ▶ Environmental compatibility and eco-footprint
- ▶ Energy efficiency and low emissions
- ▶ Longevity and optimized total cost of ownership

Certified Quality Management

ISO 9001

Certified Environmental Management

ISO 14001

Rohde & Schwarz training

www.training.rohde-schwarz.com

Rohde & Schwarz customer support

www.rohde-schwarz.com/support

