

# 深圳金逸晨电子有限公司

GoldenMorning Electronic CO.,LTD

## Product Specification

Part Name: OLED Display Module

Customer Part ID:

GM ID: GME0.91-7pin(15p)

Ver: A

Customer:

Approved by

From: GoldenMorning Electronic CO.,LTD

Approved by

### Notes:

1. Please contact GoldenMorning Electronic CO.,LTD before assigning your product based on this module specification
2. The information contained herein is presented merely to indicate the characteristics and performance of our products. No responsibility is assumed by GoldenMorning Electronic CO.,LTD for any intellectual property claims or other problems that may result from application based on the module described herein.

# 深圳金逸晨电子有限公司

GoldenMorning Electronic CO.,LTD

---

## *Revised History*

Part Number	Revision	Revision Content	Revised on
GME0.91-7pin(15p)	A	New	2021-06-25

# 深圳金逸晨电子有限公司

GoldenMorning Electronic CO.,LTD

---

## TABLE OF Contents

Part Name: OLED Display Module.....	1
1. Basic Specifications.....	5
1.1 Display Specifications.....	5
1.2 Mechanical Specifications.....	5
1.3 Active Area / Memory Mapping & Pixel Construction.....	5
1.4 Mechanical Drawing.....	6
1.5 Pin Definition.....	7
1.6 product picture.....	7
1.7 Schematic Diagram.....	8
2. Absolute Maximum Ratings.....	9
3. Optics & Electrical Characteristics.....	10
3.1 Optics Characteristics.....	10
3.2 DC Characteristics.....	10
3.3 AC Characteristics.....	11
3.3.1 SPI Interface Timing Characteristics:.....	11
4. Functional Specification.....	13
4.1 Commands.....	13
4.2 VCC Generated by Internal DC/DC Circuit.....	14
5. Reliability.....	18
5.1 Contents of Reliability Tests.....	18
5.2 Failure Check Standard.....	18
6. Outgoing Quality Control Specifications.....	18
6.1 Environment Required.....	18
6.2 Sampling Plan.....	19
6.3 Criteria & Acceptable Quality Level.....	19
6.3.1 Cosmetic Check (Display Off) in Non-Active Area.....	19
6.3.2 Cosmetic Check (Display Off) in Active Area.....	19
6.3.3 Pattern Check (Display On) in Active Area.....	21
7. Precautions When Using These OEL Display Modules.....	22
7.1 Handling Precautions.....	22

# 深圳金逸晨电子有限公司

GoldenMorning Electronic CO.,LTD

---

7.2	Storage Precautions.....	23
7.3	Designing Precautions.....	23
7.4	Precautions when disposing of the OEL display modules.....	24
7.5	Other Precautions.....	24
<b>Notice:</b>	.....	25

## 1. Basic Specifications

### 1.1 Display Specifications

- |                   |                    |
|-------------------|--------------------|
| 1) Display Mode:  | Passive Matrix     |
| 2) Display Color: | Monochrome (White) |
| 3) Drive Duty:    | 1/32 Duty          |

### 1.2 Mechanical Specifications

- |                      |  |
|----------------------|--|
| 1) Outline Drawing:  | According to the annexed outline drawing |
| 2) Number of Pixels: | 128 × 32                                 |
| 3) PCB Size:         | 32.5×20.5× 2.6 (mm)                      |
| 4) Active Area:      | 22.384 × 5.584 (mm)                      |
| 5) Pixel Pitch:      | 0.175 × 0.175 (mm)                       |
| 6) Pixel Size:       | 0.159 × 0.159 (mm)                       |

### 1.3 Active Area / Memory Mapping & Pixel Construction

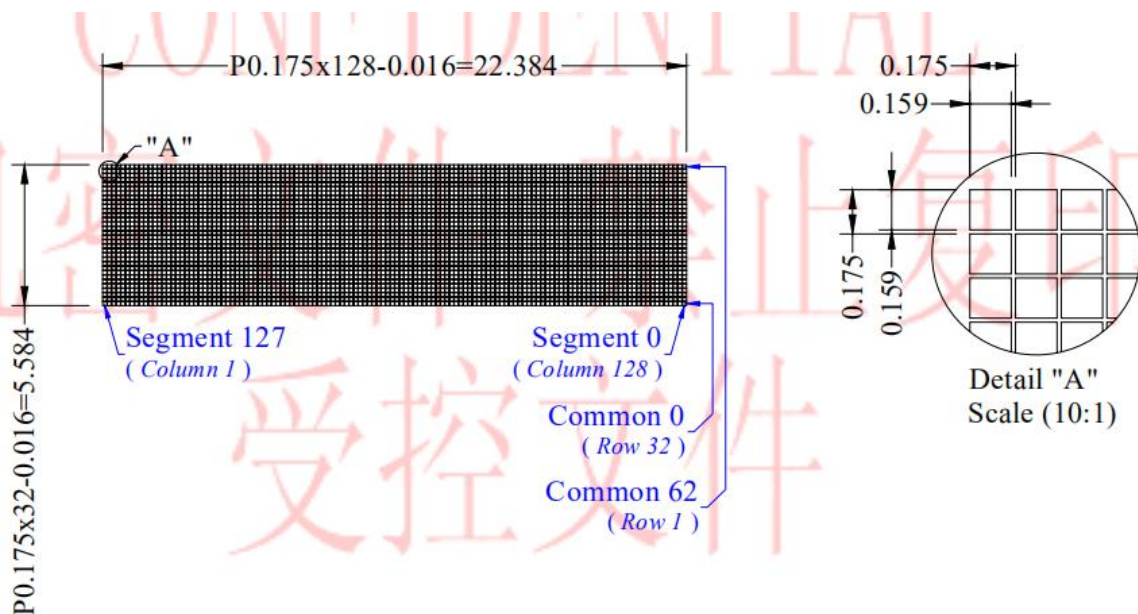

## 1.4 Mechanical Drawing

VER.	REVISED RECORD	DATA
V1.0	第一次发行 (PCB V1.0)	2021-06-25

### 1. 外形图

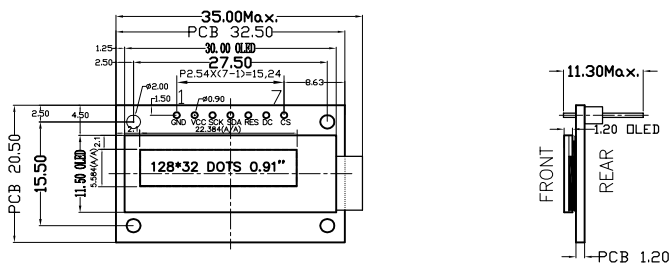

### 2. 功能&特性

- 2-1. 点阵: 128x32 Dots(0.91")
- 2-2. OLED模式: 正性  
POLARIZER MODE: TRANSMISSIVE/NORMALLY BLACK  
VIEWING DIRECTION: All
- 2-3. 单色显示
- 2-4. LCM电源供电电压 (模块第2脚VCC): 3.3~5V
- 2-5. 工作温度: -40℃~70℃
- 2-6. 储存温度: -40℃~80℃
- 2-7. 连接方式/驱动IC: COG/SSD1306  
接口: SPI

### 3. 机械规格

- 3-1. 模块尺寸: 35.00mm(L)\*20.50mm(W)\*11.30Maxmm(T)
- 3-2. 可视区域(V/A): 24.384mm(L)\*7.584mm(W)
- 3-3. 有效区域(A/A): 22.384mm(L)\*5.584mm(W)
- 3-4. 点距离: 0.175mm(L)\*0.175mm(W)
- 3-5. 点尺寸: 0.159mm(L)\*0.159mm(W)

PIN	DESCRIPTION
1	GND
2	VCC
3	SCL
4	SDA
5	RES
6	DC
7	CS

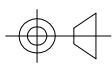
		<h2>金逸晨电子有限公司</h2>	
SHEET: 1 of 1			
APPROVALS		DATE	
DWN	ZJP	2021-06-25	
CHK		MODEL NUMBER :	
APP		GME0.91-7pin(15p)_LCM	
		SCALE:	
		UNSPECIFIED TOL: ± 0.1	
		UNITS: MM	
DO NOT SCALE THIS DRAWING.			

# 深圳金逸晨电子有限公司

## GoldenMorning Electronic CO.,LTD

### 1.5 Pin Definition

PIN No.	Symbol	Description
1	GND	<b>Ground of Logic Circuit</b> This is a ground pin. It must be connected to ground
2	VCC	<b>Power Supply for OLED</b> This is a voltage supply pin. It must be connected to source
3	SCL	<b>The serial clock input SCL</b>
4	SDA	<b>The serial data input SDA</b>
5	RES	<b>Power Reset for Controller and Driver</b> This pin is reset signal input. When the pin is low, initialization of the chip is executed. Keep this pin pull high during normal operation
6	DC	<b>Data/Command Control</b> This pin is Data/Command control pin. When the pin is pulled high, the input at SDA is treated as display data. When the pin is pulled low, the input at SDA will be transferred to the command register.
7	CS	<b>Chip Select</b> This pin is the chip select pin. Low enable, high disable.

### 1.6 product picture

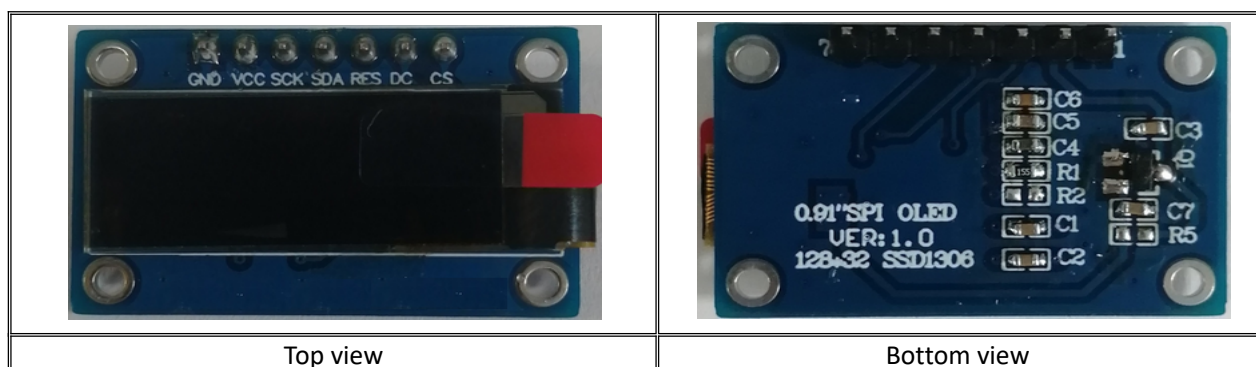

# 深圳金逸晨电子有限公司

GoldenMorning Electronic CO.,LTD

## 1.7 Schematic Diagram

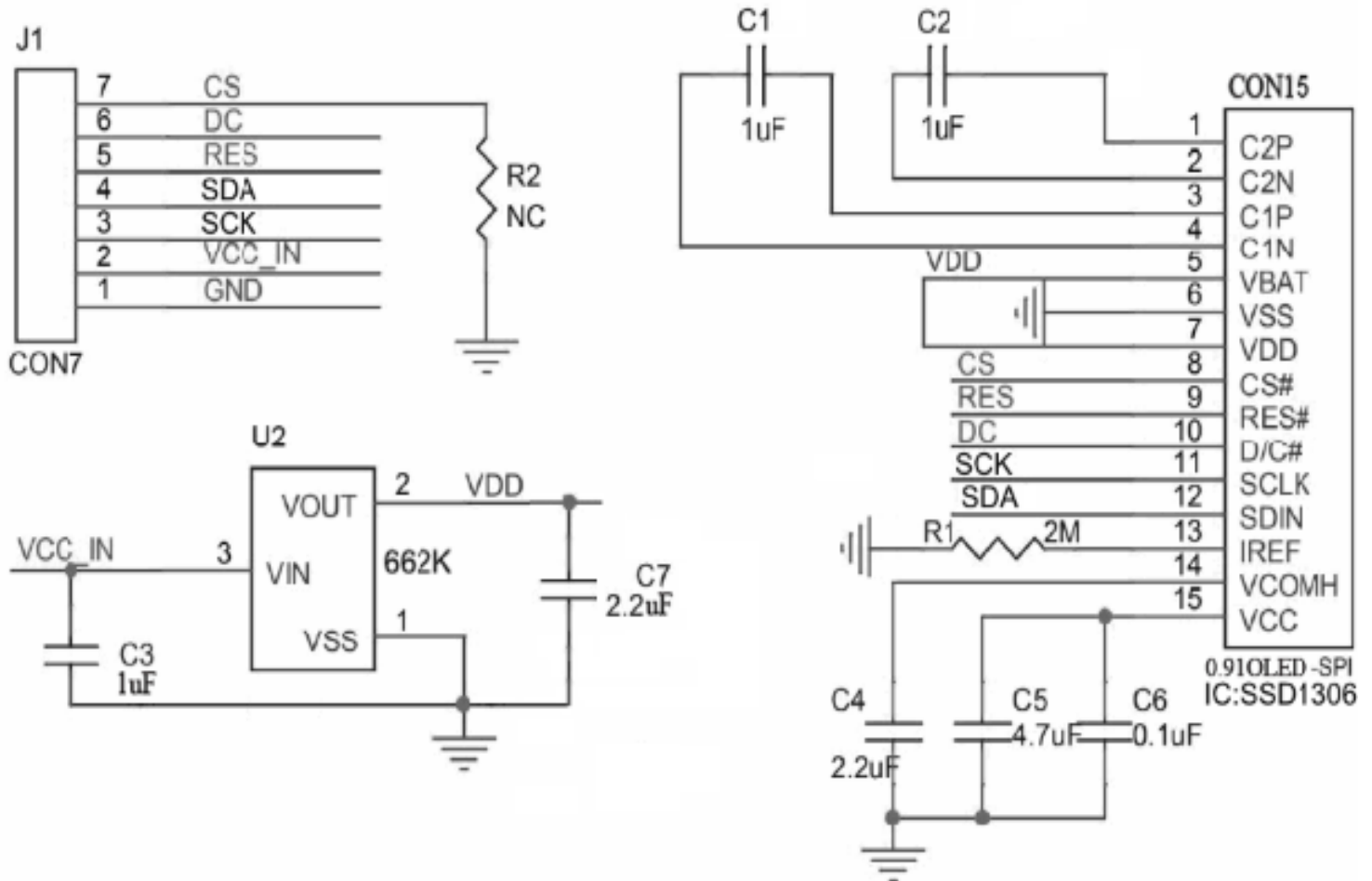



# 深圳金逸晨电子有限公司

GoldenMorning Electronic CO.,LTD

## 2. Absolute Maximum Ratings

Parameter	Symbol	Min	Max	Unit	Notes
Supply Voltage for Display	VCC	3	5	V	1, 2
Supply Voltage for Logic	SCL/SDA/RES/DC/CS	1.65	3.3	V	
Operating Temperature	T <sub>OP</sub>	-40	80	°C	
Storage Temperature	T <sub>STG</sub>	-40	85	°C	3
Life Time (120 cd/m <sup>2</sup> )		10,000	-	hour	4
Life Time (80 cd/m <sup>2</sup> )		30,000	-	hour	4
Life Time (60 cd/m <sup>2</sup> )		50,000	-	hour	4

Note 1: All the above voltages are on the basis of "GND = 0V".

Note 2: When this module is used beyond the above absolute maximum ratings, permanent breakage of the module may occur. Also, for normal operations, it is desirable to use this module under the conditions according to Section 3. "Optics & Electrical Characteristics". If this module is used beyond these conditions, malfunctioning of the module can occur and the reliability of the module may deteriorate.

Note 3: The defined temperature ranges do not include the polarizer. The maximum withstood temperature of the polarizer should be 80°C.

Note 4: VCC = 3.3 V, T<sub>a</sub> = 25°C, 50% Checkerboard.

Software configuration follows Section 4.4 Initialization.

End of lifetime is specified as 50% of initial brightness reached. The average operating lifetime at room temperature is estimated by the accelerated operation at high temperature conditions.

# 深圳金逸晨电子有限公司

GoldenMorning Electronic CO.,LTD

## 3. Optics & Electrical Characteristics

### 3.1 Optics Characteristics

Characteristics	Symbol	Conditions	Min	Typ	Max	Unit
Brightness (VCC Supplied Externally)	L <sub>br</sub>	Note 5	150	-	-	cd/m <sup>2</sup>
Brightness (VCC Generated by Internal DC/DC)	L <sub>br</sub>	Note 6	150	180	-	cd/m <sup>2</sup>
C.I.E.	(x) (y)	C.I.E. 1931	0.28 0.31	0.32 0.35	0.36 0.39	
Dark Room Contrast	CR		-	2000:1	-	
Viewing Angle			-	Free	-	degree

\* Optical measurement taken at VDD = 2.8V, VCC = 7.25V.

Software configuration follows Section 4.2 Initialization.

### 3.2 DC Characteristics

Characteristics	Symbol	Conditions	Min	Typ	Max	Unit
Supply Voltage for Logic	V <sub>DD</sub>		1.65	2.8	3.3	V
Supply Voltage for Display (Supplied Externally)	V <sub>CC</sub>	Note 5 (Internal DC/DC Disable)	6.4	-	9	V
Supply Voltage for DC/DC	V <sub>BAT</sub>	Internal DC/DC Enable	3.5	-	4.2	V
Supply Voltage for Display (Generated by Internal DC/DC)	V <sub>CC</sub>	Note 6 (Internal DC/DC Enable)	7.0	7.25	7.5	V
High Level Input	V <sub>IH</sub>	I <sub>OUT</sub> = 100μA, 3.3MHz	0.8xV <sub>DD</sub>	-	V <sub>DD</sub>	V
Low Level Input	V <sub>IL</sub>	I <sub>OUT</sub> = 100μA, 3.3MHz	0	-	0.2xV <sub>DD</sub>	V
High Level Output	V <sub>OH</sub>	I <sub>OUT</sub> = 100μA, 3.3MHz	0.9xV <sub>DD</sub>	-	V <sub>DD</sub>	V
Low Level Output	V <sub>OL</sub>	I <sub>OUT</sub> = 100μA, 3.3MHz	0	-	0.1xV <sub>DD</sub>	V
Operating Current for VDD	I <sub>DD</sub>		-	180	300	uA
Operating Current for VCC (VCC Supplied Externally)	I <sub>CC</sub>	Note 7	-	10	16	mA
Operating Current for VBAT (VCC Generated by Internal DC/DC)	I <sub>BAT</sub>	Note 8	-	23	29	mA
Sleep Mode Current for VDD	I <sub>DD,SLEEP</sub>		-	1	5	uA
Sleep Mode Current for VCC	I <sub>CC,SLEEP</sub>		-	2	10	uA

# 深圳金逸晨电子有限公司

## GoldenMorning Electronic CO.,LTD

Note 5 & 6: Brightness (Lbr) and Supply Voltage for Display (VCC) are subject to the change of the panel characteristics and the customer's request.

Note 7: VDD = 2.8V, VCC = 7.25V, 100% Display Area Turn on.

Note 8: VDD = 2.8V, VCC = 7.25V, 100% Display Area Turn on.

\* Software configuration follows Section 4.4 Initialization.

### 3.3AC Characteristics

#### 3.3.1 SPI Interface Timing Characteristics:

Symbol	Description	Min	Max	Unit
$t_{cycle}$	Clock Cycle Time	100	-	ns
$t_{AS}$	Address Setup Time	15	-	ns
$t_{AH}$	Address Hold Time	15	-	ns
$t_{CSS}$	Chip Select Setup Time	20	-	ns
$t_{CSH}$	Chip Select Hold Time	10	-	ns
$t_{DSW}$	Write Data Setup Time	15	-	ns
$t_{DHW}$	Write Data Hold Time	15	-	ns
$t_{CLKL}$	Clock Low Time	20	-	ns
$t_{CLKH}$	Clock High Time	20	-	ns
$t_R$	Rise Time	-	40	ns
$t_F$	Fall Time	-	40	ns

# 深圳金逸晨电子有限公司

## GoldenMorning Electronic CO.,LTD

\* ( $V_{DD} - V_{SS} = 1.65V$  to  $3.3V$ ,  $T_a = 25^\circ C$ )

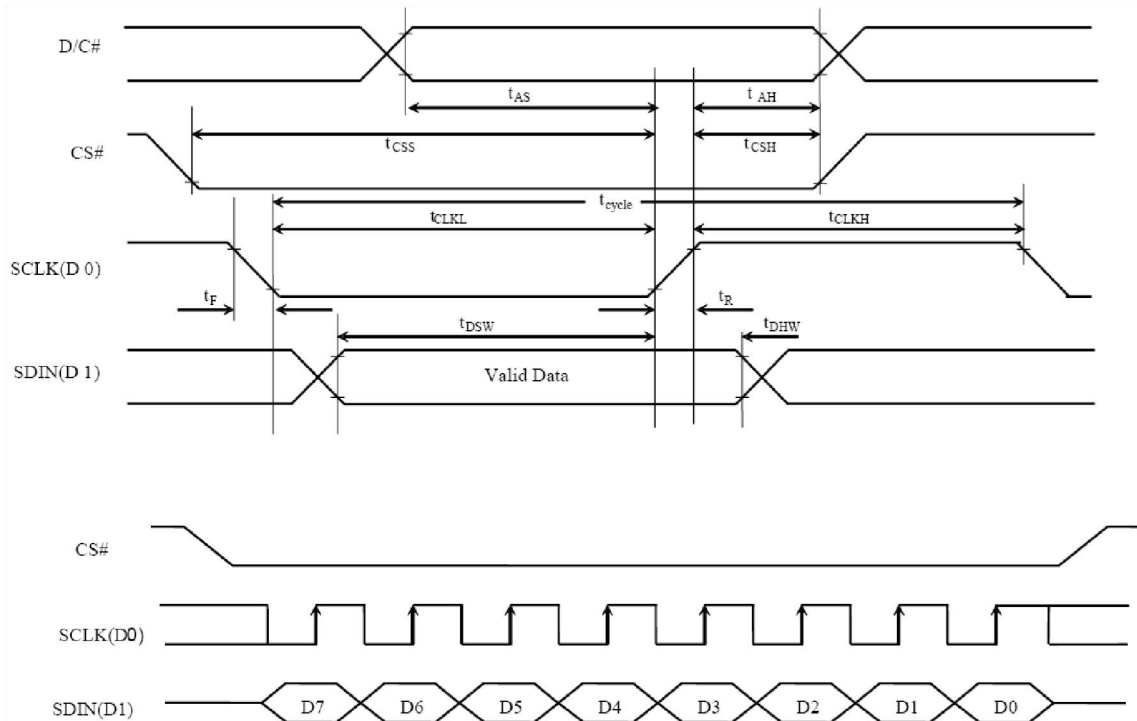

# 深圳金逸晨电子有限公司

## GoldenMorning Electronic CO.,LTD

## 4. Functional Specification

### 4.1 Commands

D/C#	Hex	D7	D6	D5	D4	D3	D2	D1	D0	Command	Description												
00	81 A[7:0]	1 A <sub>7</sub>	0 A <sub>6</sub>	0 A <sub>5</sub>	0 A <sub>4</sub>	0 A <sub>3</sub>	0 A <sub>2</sub>	0 A <sub>1</sub>	1 A <sub>0</sub>	Set Contrast Control	Double byte command to select 1 out of 256 contrast steps. Contrast increases as the value increases. (RESET = 7Fh )												
00	DB A[7:0] ]	1 0	1 A <sub>6</sub>	0 A <sub>5</sub>	1 A <sub>4</sub>	1 0	0 0	1 0	1 0	Set V <sub>COMH</sub> Deselect Level	<table border="1"> <thead> <tr> <th>A[6:4]</th> <th>Hex code</th> <th>V<sub>COMH</sub> deselect level</th> </tr> </thead> <tbody> <tr> <td>000b</td> <td>00h</td> <td>~ 0.65 x V<sub>CC</sub></td> </tr> <tr> <td>010b</td> <td>20h</td> <td>~ 0.77 x V<sub>CC</sub> (RESET)</td> </tr> <tr> <td>011b</td> <td>30h</td> <td>~ 0.83 x V<sub>CC</sub></td> </tr> </tbody> </table>	A[6:4]	Hex code	V <sub>COMH</sub> deselect level	000b	00h	~ 0.65 x V <sub>CC</sub>	010b	20h	~ 0.77 x V <sub>CC</sub> (RESET)	011b	30h	~ 0.83 x V <sub>CC</sub>
A[6:4]	Hex code	V <sub>COMH</sub> deselect level																					
000b	00h	~ 0.65 x V <sub>CC</sub>																					
010b	20h	~ 0.77 x V <sub>CC</sub> (RESET)																					
011b	30h	~ 0.83 x V <sub>CC</sub>																					
0	A6/A7	1	0	1	0	0	1	1	X <sub>0</sub>	Set Normal/Inverse Display	A6h, X[0]=0b: Normal display (RESET) 0 in RAM: OFF in display panel 1 in RAM: ON in display panel A7h, X[0]=1b: Inverse display 0 in RAM: ON in display panel 1												
0	AE AF	1	0	1	0	1	1	1	X <sub>0</sub>	Set Display ON/OFF	AEh, X[0]=0b: Display OFF (sleep mode) (RESET) AFh X[0]=1b: Display ON in normal mode												
0	A0/A1	1	0	1	0	0	0	0	X <sub>0</sub>	Set Segment Re-map	A0h, X[0]=0b: column address 0 is mapped to SEG0 (RESET) A1h, X[0]=1b: column address 127 is mapped to SEG0												
0	C0/C8	1	1	0	0	X <sub>3</sub>	0	0	0	Set COM Output Scan Direction	C0h, X[3]=0b: normal mode (RESET) Scan from COM0 to COM[N-1] C8h, X[3]=1b: remapped mode. Scan from COM[N-1] to COM0 Where N is the Multiplex ratio.												

# 深圳金逸晨电子有限公司

GoldenMorning Electronic CO.,LTD

## 4.2 VCC Generated by Internal DC/DC Circuit

Power up sequence:

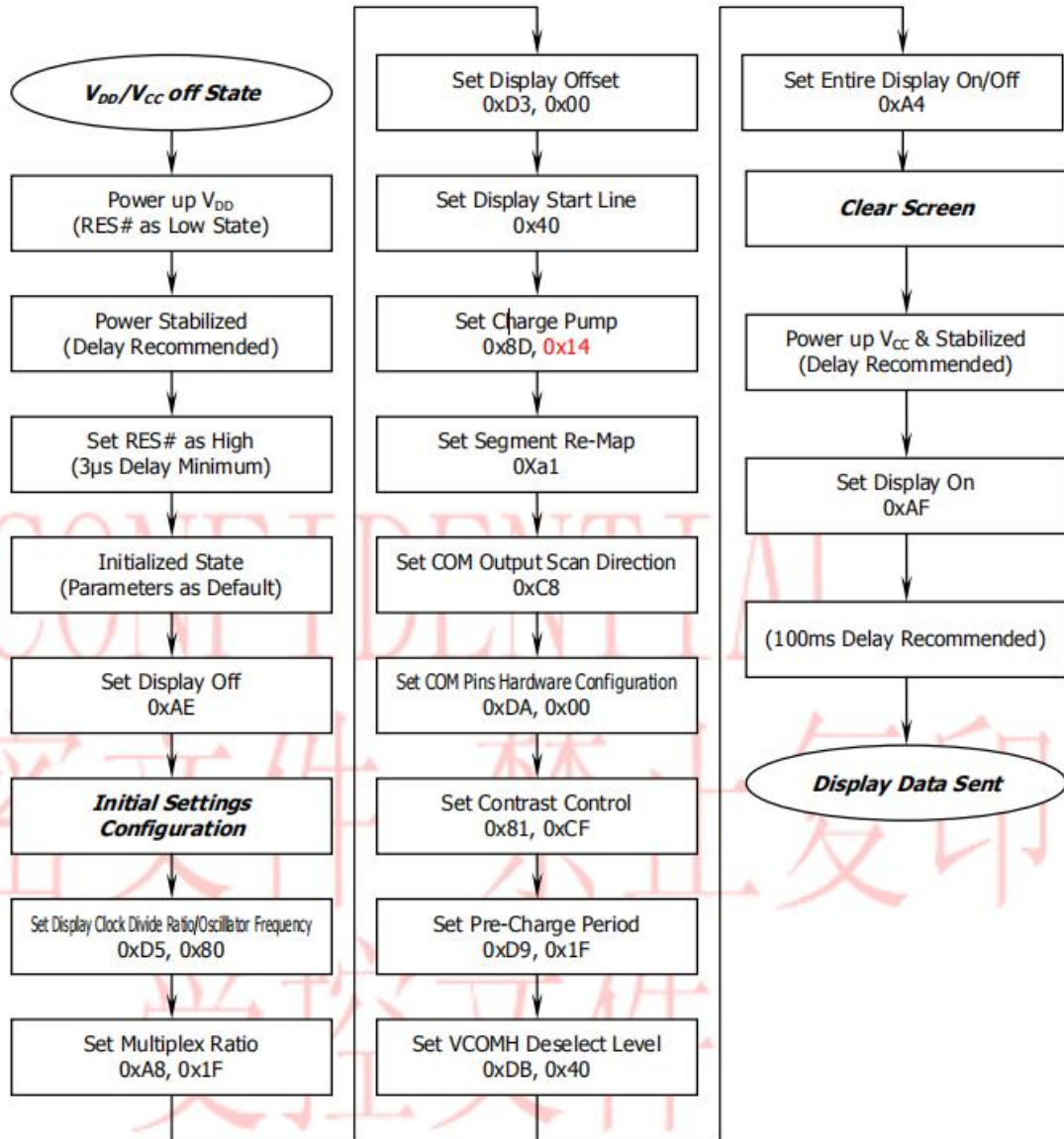

If the noise is accidentally occurred at the displaying window during the operation, please reset the display in order to recover the display function.

# 深圳金逸晨电子有限公司

GoldenMorning Electronic CO.,LTD

## <Power down Sequence>

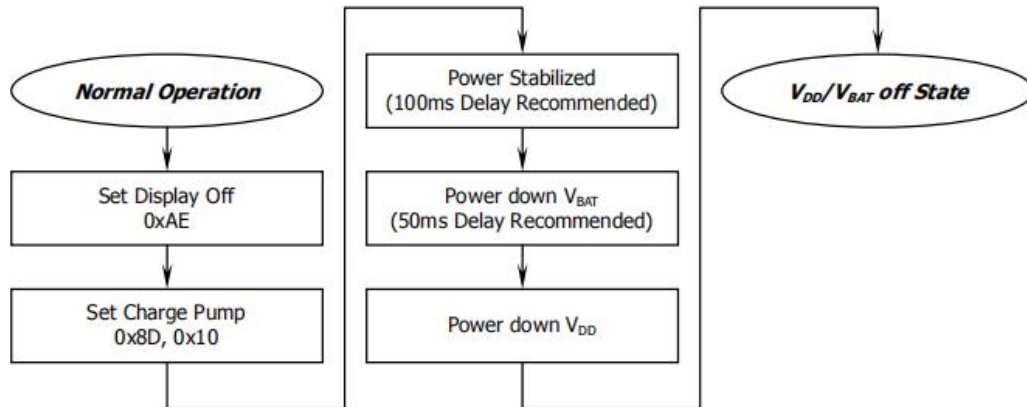

## <Entering Sleep Mode>

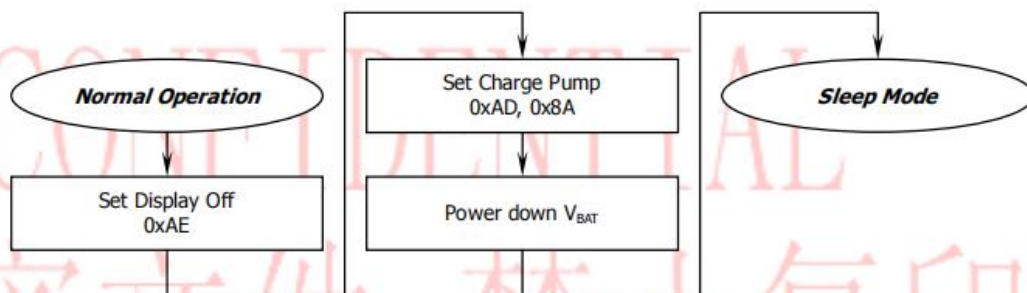

## <Exiting Sleep Mode>

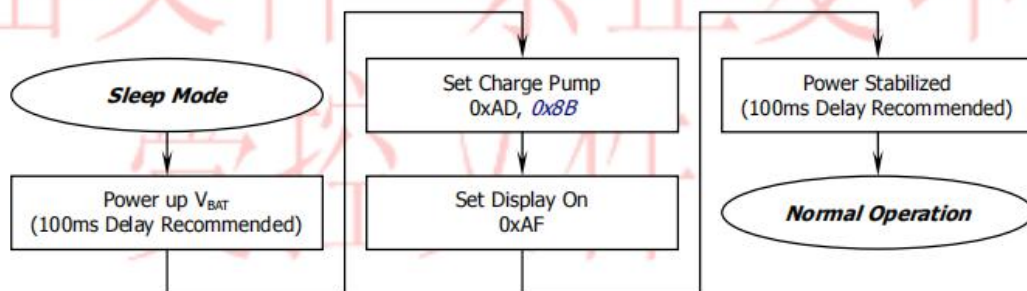

# 深圳金逸晨电子有限公司

GoldenMorning Electronic CO.,LTD

---

```
void OLED_Init(void)
{
    //OLED 复位
    OLED_RES_Clr();//RES 置 0
    delay_ms(200);//延时 200ms
    OLED_RES_Set();//RES 置 1

    //OLED 初始化
    OLED_WR_Byte(0xAE,OLED_CMD); /*display off*/
    OLED_WR_Byte(0x00,OLED_CMD); /*set lower column address*/
    OLED_WR_Byte(0x10,OLED_CMD); /*set higher column address*/
    OLED_WR_Byte(0x00,OLED_CMD); /*set display start line*/
    OLED_WR_Byte(0xB0,OLED_CMD); /*set page address*/
    OLED_WR_Byte(0x81,OLED_CMD); /*contract control*/
    OLED_WR_Byte(0xff,OLED_CMD); /*128*/
    OLED_WR_Byte(0xA1,OLED_CMD); /*set segment remap*/
    OLED_WR_Byte(0xA6,OLED_CMD); /*normal / reverse*/
    OLED_WR_Byte(0xA8,OLED_CMD); /*multiplex ratio*/
    OLED_WR_Byte(0x1F,OLED_CMD); /*duty = 1/32*/
    OLED_WR_Byte(0xC8,OLED_CMD); /*Com scan direction*/
    OLED_WR_Byte(0xD3,OLED_CMD); /*set display offset*/
    OLED_WR_Byte(0x00,OLED_CMD);
    OLED_WR_Byte(0xD5,OLED_CMD); /*set osc division*/
    OLED_WR_Byte(0x80,OLED_CMD);
    OLED_WR_Byte(0xD9,OLED_CMD); /*set pre-charge period*/
    OLED_WR_Byte(0x1f,OLED_CMD);
    OLED_WR_Byte(0xDA,OLED_CMD); /*set COM pins*/
    OLED_WR_Byte(0x00,OLED_CMD);
    OLED_WR_Byte(0xdb,OLED_CMD); /*set vcomh*/
    OLED_WR_Byte(0x40,OLED_CMD);
    OLED_WR_Byte(0x8d,OLED_CMD); /*set charge pump enable*/
    OLED_WR_Byte(0x14,OLED_CMD);
    OLED_Clear();
    OLED_WR_Byte(0xAF,OLED_CMD); /*display ON*/
}
```



# 深圳金逸晨电子有限公司

GoldenMorning Electronic CO.,LTD

---

```
#define OLED_CMD  0  //write command
#define OLED_DATA 1  //write data

void OLED_WR_Byte(u8 dat,u8 cmd)
{
    u8 i;
    if(cmd)
        OLED_DC_Set();
    else
        OLED_DC_Clr();
    OLED_CS_Clr();
    for(i=0;i<8;i++)
    {
        OLED_SCL_Clr();
        if(dat&0x80)
            OLED_SDA_Set();
        else
            OLED_SDA_Clr();
        OLED_SCL_Set();
        dat<<=1;
    }
    OLED_CS_Set();
    OLED_DC_Set();
}
```

# 深圳金逸晨电子有限公司

GoldenMorning Electronic CO.,LTD

## 5. Reliability

### 5.1 Contents of Reliability Tests

Item	Conditions	Criteria
High Temperature Operation	70°C, 240 hrs	The operational functions work.
Low Temperature Operation	-40°C, 240 hrs	
High Temperature Storage	85°C, 240 hrs	
Low Temperature Storage	-40°C, 240 hrs	
High Temperature/Humidity Operation	60°C, 90% RH, 120 hrs	
Thermal Shock	-40°C ⇔ 85°C, 24 cycles 60 mins dwell	

- \* The samples used for the above tests do not include polarizer.
- \* No moisture condensation is observed during tests.

### 5.2 Failure Check Standard

After the completion of the described reliability test, the samples were left at room temperature for 2 hrs prior to conducting the failure test at 23±5°C; 55±15% RH.

## 6. Outgoing Quality Control Specifications

### 6.1 Environment Required

Customer's test & measurement are required to be conducted under the following conditions:

- Temperature: 23 ± 5°C
- Humidity: 55 ± 15% RH
- Fluorescent Lamp: 30W
- Distance between the Panel & Lamp: ≥ 50cm
- Distance between the Panel & Eyes of the Inspector: ≥ 30cm
- Finger glove (or finger cover) must be worn by the inspector.
- Inspection table or jig must be anti-electrostatic.

# 深圳金逸晨电子有限公司

## GoldenMorning Electronic CO.,LTD

### 6.2 Sampling Plan

Level II, Normal Inspection, Single Sampling, MIL-STD-105E

### 6.3 Criteria & Acceptable Quality Level

Partition	AQL	Definition
Major	0.65	Defects in Pattern Check (Display On)
Minor	1.0	Defects in Cosmetic Check (Display Off)

#### 6.3.1 Cosmetic Check (Display Off) in Non-Active Area

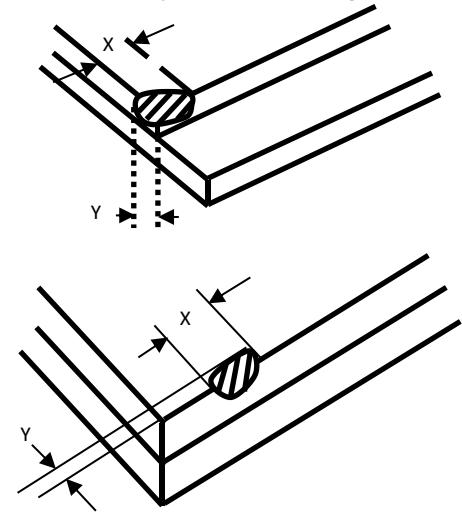
Check Item	Classification	Criteria
Panel General Chipping	Minor	<p>X &gt; 6 mm (Along with Edge) Y &gt; 1 mm (Perpendicular to edge)</p> 

#### 6.3.2 Cosmetic Check (Display Off) in Active Area

It is recommended to execute in clear room environment (class 10k) if actual in necessary.

Check Item	Classification	Criteria
Any Dirt & Scratch on Polarizer's Protective Film	Acceptable	Ignore for not Affect the Polarizer

# 深圳金逸晨电子有限公司

GoldenMorning Electronic CO.,LTD

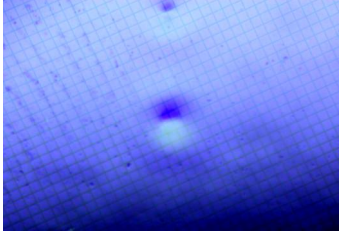
Scratches, Fiber, Line-Shape Defect (On Polarizer)	Minor	$W \leq 0.1$ $W > 0.1$ $L \leq 2$ $L > 2$	Ignore $n \leq 1$ $n = 0$
Dirt, Black Spot, Foreign Material, (On Polarizer)	Minor	$\Phi \leq 0.1$ $0.1 < \Phi \leq 0.25$ $0.25 < \Phi$	Ignore $n \leq 1$ $n = 0$
Dent, Bubbles, White spot (Any Transparent Spot on Polarizer)	Minor	$\Phi \leq 0.5$ → Ignore if no Influence on Display $0.5 < \Phi$	$n = 0$ 
Fingerprint, Flow Mark (On Polarizer)	Minor	Not Allowable	

\* Protective film should not be tear off when cosmetic check.

\*\* Definition of W & L &  $\Phi$  (Unit: mm):  $\Phi = (a + b) / 2$

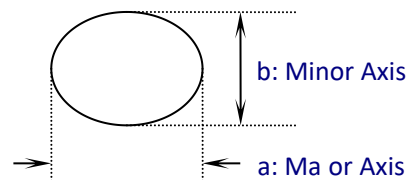
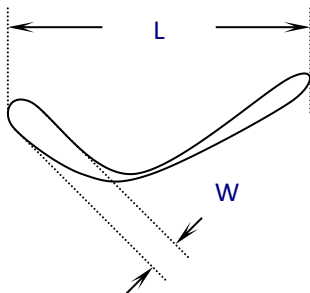

# 深圳金逸晨电子有限公司

## GoldenMorning Electronic CO.,LTD

### 6.3.3 Pattern Check (Display On) in Active Area

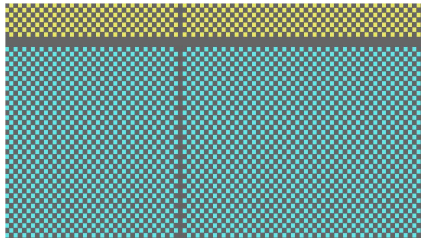
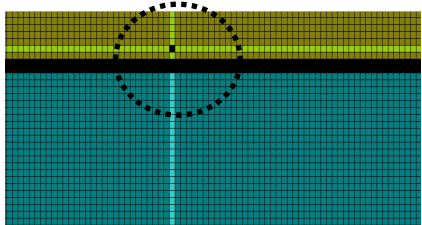
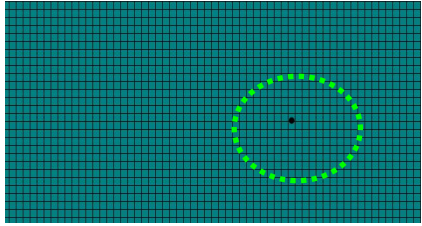
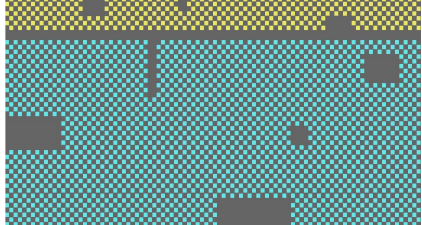
Check Item	Classification	Criteria
No Display	Major	
Missing Line	Major	
Pixel Short	Major	
Darker Pixel	Major	
Wrong Display	Major	

# 深圳金逸晨电子有限公司

## GoldenMorning Electronic CO.,LTD

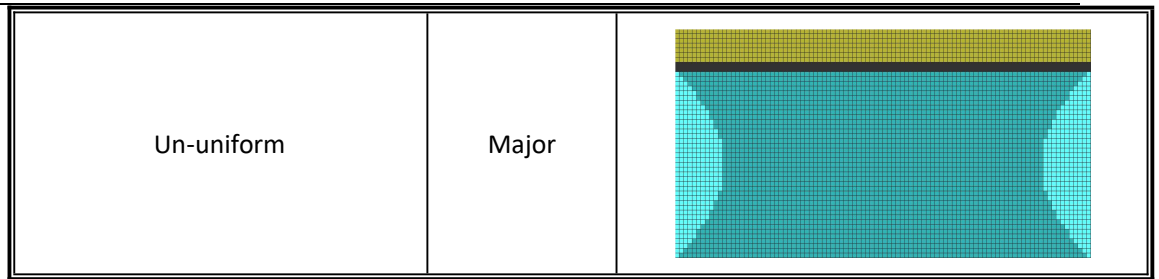

## 7. Precautions When Using These OEL Display Modules

### 7.1 Handling Precautions

- 1) Since the display panel is being made of glass, do not apply mechanical impacts such as dropping from a high position.
- 2) If the display panel is broken by some accident and the internal organic substance leaks out, be careful not to inhale nor lick the organic substance.
- 3) If pressure is applied to the display surface or its neighborhood of the OEL display module, the cell structure may be damaged and be careful not to apply pressure to these sections.
- 4) The polarizer covering the surface of the OEL display module is soft and easily scratched. Please be careful when handling the OEL display module.
- 5) When the surface of the polarizer of the OEL display module has soil, clean the surface. It takes advantage of by using following adhesion tape.

\* Scotch Mending Tape No. 810 or an equivalent

Never try to breathe upon the soiled surface nor wipe the surface using cloth containing solvent such as ethyl alcohol, since the surface of the polarizer will become cloudy.

Also, pay attention that the following liquid and solvent may spoil the polarizer:

- \* Water
  - \* Ketone
  - \* Aromatic Solvents
- 6) Hold OEL display module very carefully when placing OEL display module into the system housing. Do not apply excessive stress or pressure to OEL display module. And, do not over bend the film with electrode pattern layouts. These stresses will influence the display performance. Also, secure sufficient rigidity for the outer cases.

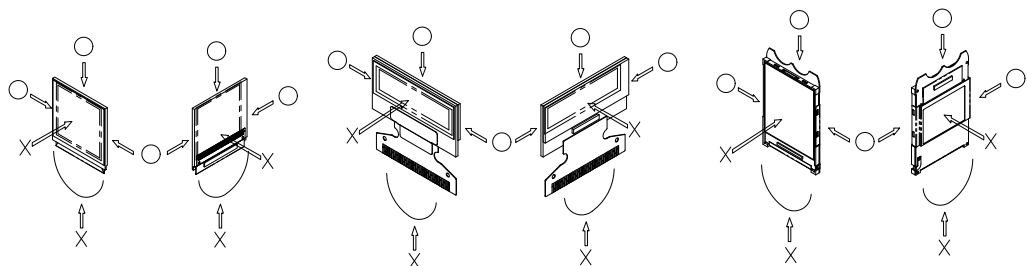

- 7) Do not apply stress to the driver IC and the surrounding molded sections.
- 8) Do not disassemble nor modify the OEL display module.

# 深圳金逸晨电子有限公司

## GoldenMorning Electronic CO.,LTD

---

- 9) Do not apply input signals while the logic power is off.
- 10) Pay sufficient attention to the working environments when handing OEL display modules to prevent occurrence of element breakage accidents by static electricity.
  - \* Be sure to make human body grounding when handling OEL display modules.
  - \* Be sure to ground tools to use or assembly such as soldering irons.
  - \* To suppress generation of static electricity, avoid carrying out assembly work under dry environments.
  - \* Protective film is being applied to the surface of the display panel of the OEL display module. Be careful since static electricity may be generated when exfoliating the protective film.
- 11) Protection film is being applied to the surface of the display panel and removes the protection film before assembling it. At this time, if the OEL display module has been stored for a long period of time, residue adhesive material of the protection film may remain on the surface of the display panel after removed of the film. In such case, remove the residue material by the method introduced in the above Section 5).
- 12) If electric current is applied when the OEL display module is being dewed or when it is placed under high humidity environments, the electrodes may be corroded and be careful to avoid the above.

## 7.2 Storage Precautions

- 1) When storing OEL display modules, put them in static electricity preventive bags avoiding exposure to direct sun light nor to lights of fluorescent lamps. and, also, avoiding high temperature and high humidity environment or low temperature (less than 0 ° C) environments. (We recommend you to store these modules in the packaged state when they were shipped from GoldenMorning Electronic CO.,LTD )

At that time, be careful not to let water drops adhere to the packages or bags nor let dewing occur with them.

- 2) If electric current is applied when water drops are adhering to the surface of the OEL display module, when the OEL display module is being dewed or when it is placed under high humidity environments, the electrodes may be corroded and be careful about the above.

## 7.3 Designing Precautions

- 1) The absolute maximum ratings are the ratings which cannot be exceeded for OEL display module, and if these values are exceeded, panel damage may be happen.
- 2) To prevent occurrence of malfunctioning by noise, pay attention to satisfy the  $V_{IL}$  and  $V_{IH}$  specifications and, at the same time, to make the signal line cable as short as possible.
- 3) We recommend you to install excess current preventive unit (fuses, etc.) to the power circuit ( $V_{DD}$ ). (Recommend value: 0.5A)
- 4) Pay sufficient attention to avoid occurrence of mutual noise interference with the neighboring devices.
- 5) As for EMI, take necessary measures on the equipment side basically.
- 6) When fastening the OEL display module, fasten the external plastic housing section.

# 深圳金逸晨电子有限公司

## GoldenMorning Electronic CO.,LTD

- 
- 7) If power supply to the OEL display module is forcibly shut down by such errors as taking out the main battery while the OEL display panel is in operation, we cannot guarantee the quality of this OEL display module.
  - 8) The electric potential to be connected to the rear face of the IC chip should be as follows:  
SSD1306
- \* Connection (contact) to any other potential than the above may lead to rupture of the IC.

### 7.4 Precautions when disposing of the OEL display modules

- 1) Request the qualified companies to handle industrial wastes when disposing of the OEL display modules. Or, when burning them, be sure to observe the environmental and hygienic laws and regulations.

### 7.5 Other Precautions

- 1) When an OEL display module is operated for a long of time with fixed pattern may remain as an after image or slight contrast deviation may occur.  
Nonetheless, if the operation is interrupted and left unused for a while, normal state can be restored. Also, there will be no problem in the reliability of the module.
  - 2) To protect OEL display modules from performance drops by static electricity rapture, etc., do not touch the following sections whenever possible while handling the OEL display modules.
    - \* Pins and electrodes
    - \* Pattern layouts such as the FPC
  - 3) With this OEL display module, the OEL driver is being exposed. Generally speaking, semiconductor elements change their characteristics when light is radiated according to the principle of the solar battery. Consequently, if this OEL driver is exposed to light, malfunctioning may occur.
- \* Design the product and installation method so that the OEL driver may be shielded from light in actual usage.
- \* Design the product and installation method so that the OEL driver may be shielded from light during the inspection processes.
- 4) Although this OEL display module stores the operation state data by the commands and the indication data, when excessive external noise, etc. enters into the module, the internal status may be changed. It therefore is necessary to take appropriate measures to suppress noise generation or to protect from influences of noise on the system design.
  - 5) We recommend you to construct its software to make periodical refreshment of the operation statuses (re-setting of the commands and re-transference of the display data) to cope with catastrophic noise.



# 深圳金逸晨电子有限公司

## GoldenMorning Electronic CO.,LTD

---

### *Warranty:*

The warranty period shall last twelve (12) months from the date of delivery. Buyer shall be completed to assemble all the processes within the effective twelve (12) months. GoldenMorning Electronic CO.,LTD shall be liable for replacing any products which contain defective material or process which do not conform to the product specification, applicable drawings and specifications during the warranty period. All products must be preserved, handled and appearance to permit efficient handling during warranty period. The warranty coverage would be exclusive while the returned goods are out of the terms above.

### **Notice:**

No part of this material may be reproduced or duplicated in any form or by any means without the written permission of GoldenMorning Electronic CO.,LTD . GoldenMorning Electronic CO.,LTD reserves the right to make changes to this material without notice. GoldenMorning Electronic CO.,LTD does not assume any liability of any kind arising out of any inaccuracies contained in this material or due to its application or use in any product or circuit and, further, there is no representation that this material is applicable to products requiring high level reliability, such as, medical products. Moreover, no license to any intellectual property rights is granted by implication or otherwise, and there is no representation or warranty that anything made in accordance with this material will be free from any patent or copyright infringement of a third party. This material or portions thereof may contain technology or the subject relating to strategic products under the control of Foreign Exchange and Foreign Trade Law of Taiwan and may require an export license from the Ministry of International Trade and Industry or other approval from another government agency.