



LANBOO
中国·蓝波

2023

Good switch selection LANBOO
multiple safety functions
好开关 选蓝波 安全功能多

中国·蓝波形象大使
Brand spokesman

Dong Xuan
董璇

让用电更安全
Make Electricity Safer



LANBOO
中国·蓝波

成为开关行业世界级的引领者

BECOME A WORLD-CLASS LEADER IN THE SWITCH INDUSTRY





LANBOO
中国·蓝波

蓝波寓意：蓝图伟业，波澜壮阔。

在蓝色国土以及波涛汹涌的竞争环境下创造蓝海、绘制蓝图、建立丰功伟业。初步以电子、电器产品作为发展范围，前期以创造高品质、安全、精美、先进制造的为核心，以波澜壮阔的气势干实业。

LANBOO meaning: **Blueprint great cause, magnificent.**

Create blue oceans, draw blueprints, and build great achievements in a blue country and a turbulent competitive environment. Initially based on electronic and electrical productsThe scope of development, in the early stage, takes the creation of high-quality, safe, exquisite and advanced manufacturing as the core, and does the industry with a magnificent momentum.



关于我们

About Us

蓝波品牌成立于2014年,是一家中国无区域化公司。主要研发、制造高端金属按钮开关、继电器、指示灯、急停开关、钥匙开关、旋钮、蜂鸣器、船型开关、触摸开关等产品,具备大电流、带灯、防水、防尘、防爆等功能,可定制开发。

申请100余项国家专利及发明专利,通过ISO9001质量管理体系认证,获得CE、SGS、CCC、CQC、RoHs、TUV、REACH、CB、UL61058等认证。首创各类7A、10A、16A、25A大电流金属按钮开关,引领前沿。在前进的路上我们坚持不断创新、创造、努力打造工匠产品。

拥有多年丰富经验的研发、精益生产、高水平管理、销售精英、法律维权等团队。拥有高端数控车间、自动化车间、数字化车间、ERP与PGS管理系统。确保高质、高效、优服务,努力打造精品蓝波品牌。通过努力已成为多家知名企业优秀合作伙伴,正泰集团ODM/OEM供应商,销售网络已覆盖全球。

注册LANBOO国际商标,走向全球。LANBOO蓝波注册国内全类商标,全面覆盖保护。

砥砺前行,我们再接再厉!

LANBOO brand was established in 2014 and is a non-regionalized company in China. Mainly develop and manufacture high-end metal button switches, relays, indicator lights, emergency stop switch, key switch, knob, buzzer, rocker switch, touch switch and other products, with high current, light, waterproof, dustproof, explosion-proof and other functions. Custom development is possible.

Apply for more than 100 national patents and invention patents, pass the ISO9001 quality management system certification, and obtain CE, SGS, CCC, CQC, RoHs, TUV, REACH, CB, UL61058 and other certifications. The first to create various types of 7A, 10A, 16A, 25A high-current metal button switches, leading the forefront. On the way forward we adhere to continuous innovation, creation, and strive to create artisan products.

Has many years of rich experience in research and development, lean production, high-level management, sales elite, legal rights protection and other teams. Has a high-end CNC workshop, Automated workshop, digital workshop, ERP and PGS management system. To ensure high quality, high efficiency and excellent service, and strive to build a high-quality blue wave brand. achieved through effort As an excellent partner of many well-known enterprises, Chint Group is an ODM/OEM supplier, and its sales network has covered the world.

Register the LANBOO international trademark and go global. LANBOO has registered all kinds of domestic trademarks, covering all aspects of protection.

Forge ahead, we will make persistent efforts!

我们的愿景

成为开关行业世界级的引领者

Our Vision

Becoming a world-class leader in the switch industry

我们的使命

让用电更安全

让蓝波成为蓝波人实现梦想的舞台

Our Mission

Make electricity safer

Make Blue Wave a Stage for Blue Wave People to Realize Their Dreams

质量方针

工匠,做能感动自己的产品

创新,做认为不可能的事情

俱进,走在超越世纪最前沿

服务,付出追求爱人的热情

POLICY

Craftsman, making products that can move oneself. Innovate and do things that are considered impossible. Advancing forward, walking at the forefront of surpassing the century. Service, passion for pursuing loved ones.

蓝波价值观 LANBOO's Values

准确

- 1、准循原则, 严于律己, 确保遵纪守法;
- 2、准循目标, 思路清晰, 确保在航道;
- 3、准循需求, 标准作业, 确保不想当然;
- 4、准施任务, 凡事必确认, 确保准确无误;
- 5、准达结果, 凡事必有果, 确保是第一。

Accuracy

1. Adhere to principles, be strict with oneself, and ensure compliance with laws and regulations;
2. Follow the target accurately, have clear thinking, and ensure to be on the waterway;
3. Adhere to requirements and standard operations to ensure that one does not take things for granted;
4. Accurately carry out tasks, always confirm everything, and ensure accuracy;
5. Be sure to achieve results, everything will come to fruition, and ensure that it is the first.

高效

- 1、高效率, 没有准备不上班, 没有结果不下班, 今日事今日毕。
- 2、高品质, 不接收不良品, 不生产不良品, 不流出不良品;
- 3、高匠心, 用钻牛角尖的精神有效解决市场需求;
- 4、高成长, 八小时内求生存, 八小时外求发展;
- 5、高标准, 站在今天做未来的事。

Efficient

1. Efficient, don't go to work without preparation, don't leave work without results, finish today's work today.
2. High quality, no acceptance of defective products, no production of defective products, no outflow of defective products;
3. High craftsmanship, effectively solving market demand with a sharp and meticulous spirit;
4. High growth, seeking survival within eight hours, and seeking development beyond eight hours;
5. High standards, standing today and doing future things.

敢当

- 1、遇到问题, 敢于承担, 不推诿, 当己事;
- 2、遇到批评, 敢于接纳, 不狡辩, 当学习;
- 3、遇到变化, 敢于拥抱, 不退缩, 当机遇;
- 4、遇到委屈, 敢于站起, 不消极, 当成长;
- 5、遇到诱惑, 敢于抵抗, 不心动, 当激励。

Dare to take responsibility

1. When encountering problems, dare to take responsibility, do not shirk responsibility, and take it personally;
2. When encountering criticism, dare to accept it, do not quibble, and learn from it;
3. When encountering changes, dare to embrace, do not retreat, and be an opportunity;
4. When encountering grievances, dare to stand up, not be negative, and grow;
5. When encountering temptation, dare to resist, not be tempted, and be inspired.

敢拼

- 1、面对目标, 敢于拼搏, 拼到感动自己;
- 2、面对竞争, 敢于超越, 拼到无能为力;
- 3、面对瓶颈, 敢于挑战, 拼到最后一刻;
- 4、面对压力, 敢于皮实, 拼成最亮的星;
- 5、面对邪气, 敢于正义, 拼成骨气蓝波。

Dare to fight

1. Face the goal, dare to fight hard, and work hard to move oneself;
2. In the face of competition, dare to surpass and struggle to the point of powerlessness;
3. Face bottlenecks, dare to challenge, and fight until the last moment;
4. Faced with pressure, dare to be down-to-earth and put together the brightest star;
5. In the face of evil, dare to be righteous and form a blue wave of backbone.



敢于创新/与众不同
 蓝波拥有100余项专利 多项认证
 Dare to innovate/stand out from the crowd
 LANBOO has over 100 patents and multiple certifications



荣获“高新技术企业”
 为振兴民族品牌而不懈努力奋斗
 Awarded as a high-tech enterprise
 Striving tirelessly to revitalize national brands



让用电更安全
 安全大电流按钮开关
 Make electricity safer
 Safe high current button switch

部分客户 Part Customers



More.....

排名不分先后
 Ranking in no particular order



强大的研发能力

品种规格齐全，总有一款满足您的需求!

Variety specifications, there is always a suitable for you!

STRONG R&D Capability



P02-03 21A继电器
21A relay series

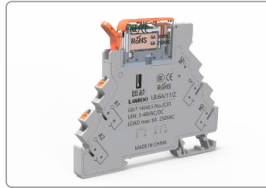

P04 J6A薄片式继电器
6mm Ultra Thin type Relay

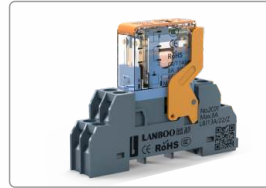

P05 J13A窄款继电器
Narrow type Relay



P06-08 大电流汽车继电器
High Power Automobile Relay



P09 可调频闪光灯
FM Flasher



P11 迷你圆形船型开关
Mini Rocket Switch



P12 20船型开关
Rocket Switch



P13 1409迷你船型开关
Mini Rocket Switch



P14 2810.5船型开关
Roker switch



P15 2822船型开关
Roker switch



P18 12E 10A迷你大电流按钮
Mini High-Current Button



P19 16/19B 15A大电流按钮
High-Current Button



P20 16E3 20A迷你短款按钮
Mini Short-lagre Current



P21 19/22E 20A短款大电流按钮
Short High-Current Button



P22 22/25C 20A大电流按钮
High-Current Button



P23 1913 20A大电流方形开关
High-Current Button



P24-25 A系列金属按钮
A Series Metal Button Switch



P26 19A1金属按钮
Metal Button Switch



P27 12B/16E 短款按钮
Short Button Switch



P28 22B/25B大电流按钮
High-Current Button



P29 19/22CM大电流触摸按钮
High current touch button



P30 16-25QC超薄轻触按钮
Ultra thin touch button



P31 16NZ钮子开关
Metal Toggle Switch



P32 16NZ2钮子开关
Metal Toggle Switch



P33 19X5旋鈕開關
Metal Knob Switch



P34 19Y5鑰匙鈕
New Key Switch



P35 帶燈急停
Stop Button with LED



P36 無燈急停
Emergency Button



P37 塑料急停
Emergency Button



P39 16F高防水按鈕
Metal Button Switch



P40 16X1旋鈕開關
Metal Knob Switch



P41 16Y1鑰匙鈕
Key Switch



P42 19X1旋鈕開關
Metal Knob Switch



P43 19Y1鑰匙鈕
Key Switch



P44 22F高防水按鈕
Metal Button Switch



P45 6-25mm信號燈系列
6-25mm Indicator Light



P46 8mm高亮指示燈
Bright Indicator Light



P47 閃光蜂鳴器
Buzzer



P48 2系列經濟款按鈕
Economic Series



P49 16SA塑料按鈕
Plastic Switch



P50-53 22SA1快捷塑料按鈕
Plastic Switch



P54-56 22SA2組合式塑料按鈕
Combined Button

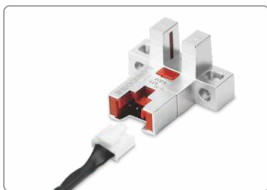

P57 光電開關
Sa1 Button Switch



P58 定制開發系列
Customization



P59 附件系列
Accessories Series

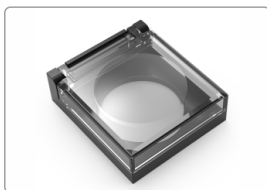

P60 保護蓋/防塵蓋
Safety Shield



P61 螺母扳手
Nut Wrench

继电器系列

Intermediate Relay Series

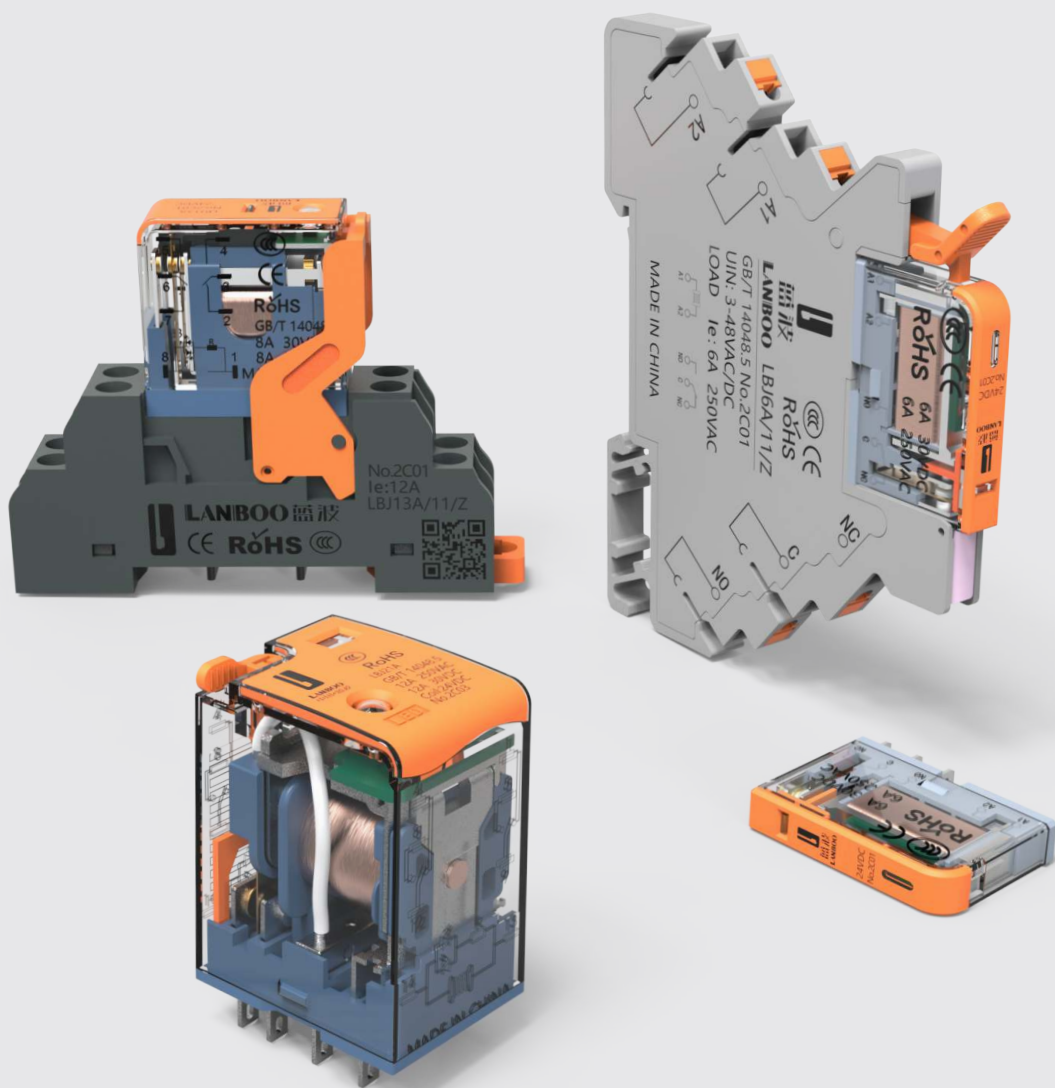

继电器命名规则 Relay Naming Rules

LB J ★ ◇ - ▲ ● □ / ▲ / ※

- 其它备注: 定制符号、防水要求、特殊颜色要求等
Other remarks: customized symbols, waterproof requirements, special color requirements, etc
- 线圈电压: DC12V、DC24V、AC220V(230V/250V);
Coil voltage: DC12V、DC24V、AC220V(230V/250V);
- 其它定制: AV/DC6V、AC/DC48V、AV/DC60V、AV/DC110V、AC12V、DC230V
Other customizations: AV/DC6V、AC/DC48V、AV/DC60V、AV/DC110V、AC12V、DC230V
- 操作方式: T-带测试扳手 无-标准型
Operation method: T - with test wrench, none - standard type
- 插脚类型: D-大插脚 无-小插脚
Pin Type: D-Large Pin None Small Pin
- 触点类型: 10-1NO, 11-1NO1NC, 22-2NO2NC, 44-4NO4NC (NO为常开触头, NC为常闭触头)
Contact types: 10-1NO, 11-1NO1NC, 22-2NO2NC, 44-4NO4NC (NO is the normally open contact, NC is the normally closed contact)
- 系列号: A、B、C.....
Series number: A、B、C.....
- 继电器厚度: 21-厚度21mm, 6-厚度6mm, 13-厚度13mm
Relay thickness: 21-thickness 21mm, 6-thickness 6mm, 13-thickness 13mm
- J-继电器代码
J-Relay Code
- 蓝波代号
LANBOO Code

LBJ21A 继电器系列

Intermediate Relay Series



DC 直流 LED灯通电状态为绿色
Power-On status is green

AC 交流 LED灯通电状态为红色
Power-On status is red

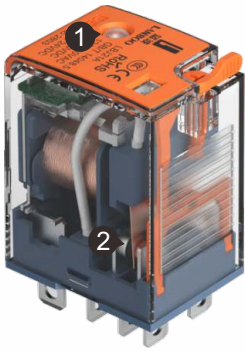

1. 未显示状态
Not Shown



2. 未切换触点状态
Unswitched Contact

常开常闭未切换前的状态
State Before Switching



1. 显示状态
Display State



2. 切换触点状态
Changeover Contact

常开常闭切换后的状态
State After Switching

大8脚(12A)
Big 8-PIN(12A)

小8脚(12A)
Small 8-PIN(12A)

小14角(5A)
Small 14-PIN(5A)

2NO 2NC

2NO 2NC

4NO 4NC

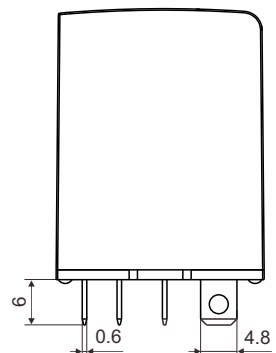
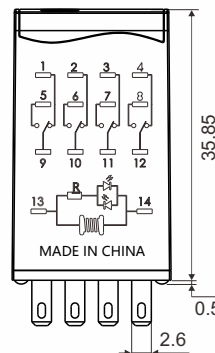
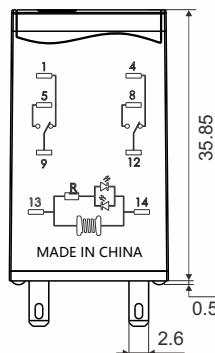
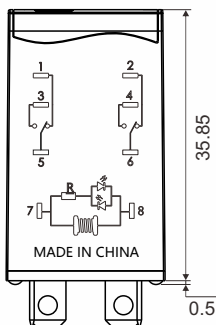
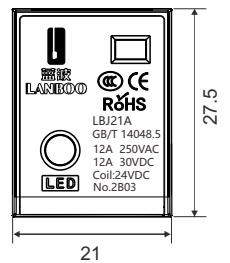
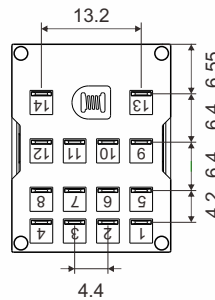
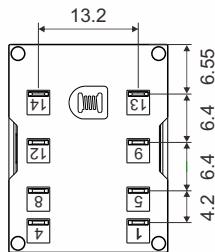
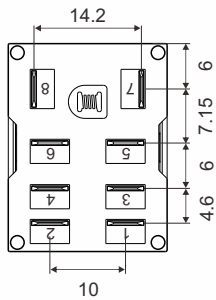

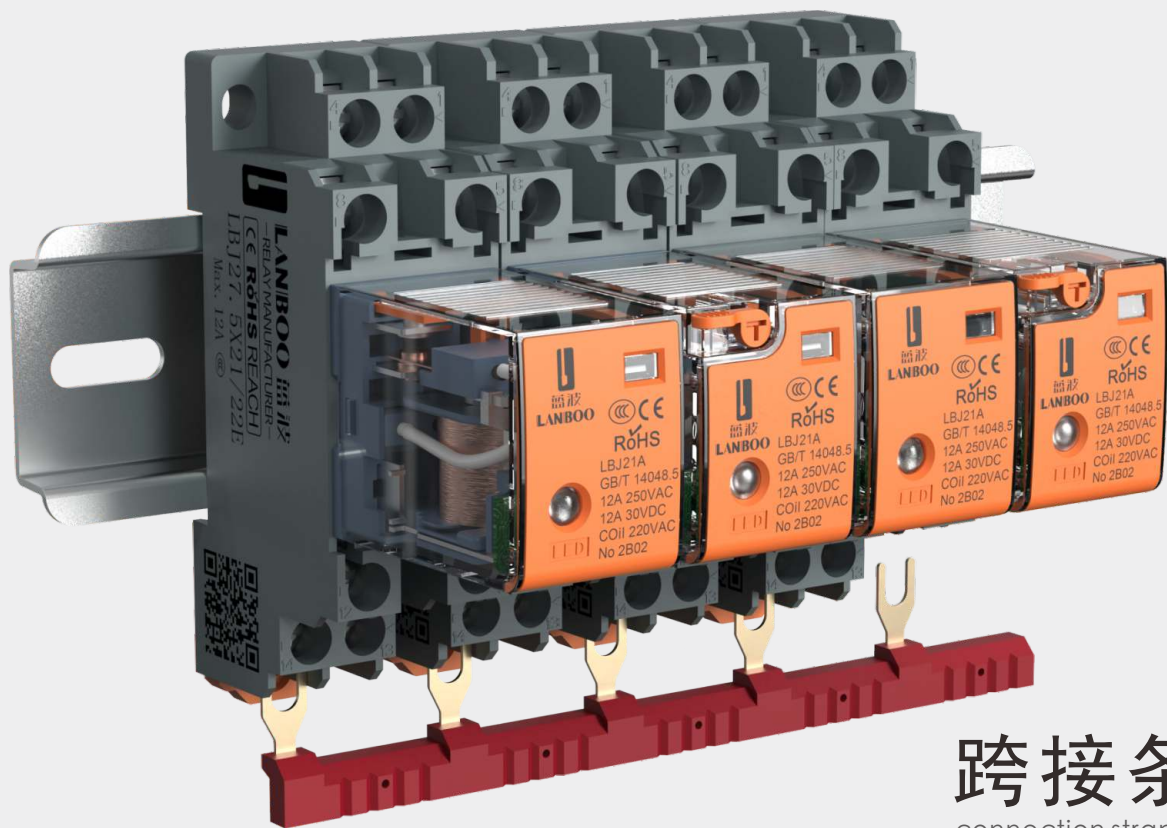

跨接条

connection strap



≤50mΩ
接触电阻
Contact Resistance



1000MΩ
绝缘电阻
Insulation Resistance



50000H
长寿命灯珠
Long Life LED



2000万次
机械寿命
Mechanical Life



底座V0
耐温阻燃
Antif Laming



-40~80°C
温度范围
Environment



CCC RoHS REACH CE
专利及认证
Certificate



带翼设计
Winged Design



阻燃耐温外壳
Flame Retardant

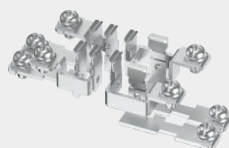

加厚插簧
Thickened Spring



导轨式卡扣
Rail type Buckle

大8脚小14脚底座专用
Large 8-Pin, small 14-Pin base jumper

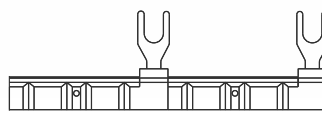

间距29mm

小8脚底座专用
Small 8-Pin base jumper

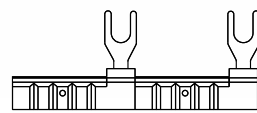

间距22mm

Blue Red Black 三种颜色可选, 间距29mm及22mm二种规格可选, 可根据需求裁剪任意长度, 一根的规格为10个端头。

Three colors are available. There are two specifications of 29mm and 22mm distance, which can be cut according to demand. Cut to any length, and the specification of one piece is 10 ends.



LBJ6A

薄片式继电器系列
6mm Ultra thin type Relay

Ith:10A

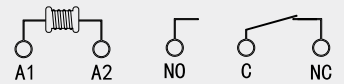
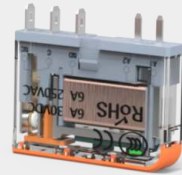
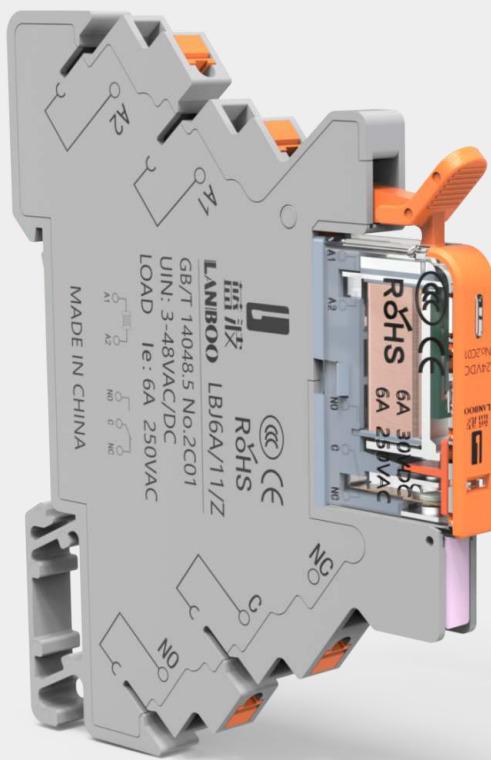

6mm
超薄设计
Ultra-thin design



≤25ms
高灵敏度
High Sensitivity



≤50mΩ
大银触点
Silver contact



1000万次
机械寿命
Mechanical Life



底座V0
耐温阻燃
Antif Laming



-40~80℃
环境耐温强
Environment



≥1000MΩ
绝缘耐压
Insulation



CCC CE RoHS
多项认证
Certificate



6mm超薄设计
Ultra-thin design



带指示灯
With LED

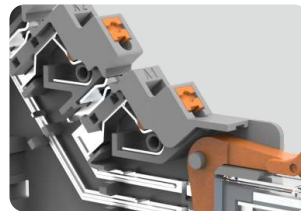

直插接线
Plug-In

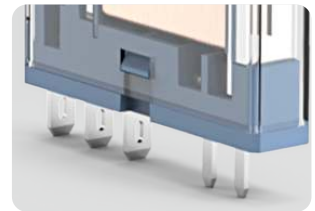

加粗插脚, 不易变形
Bold pin, not easy to deform

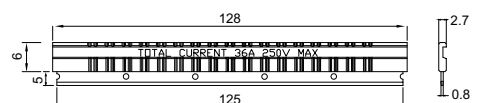
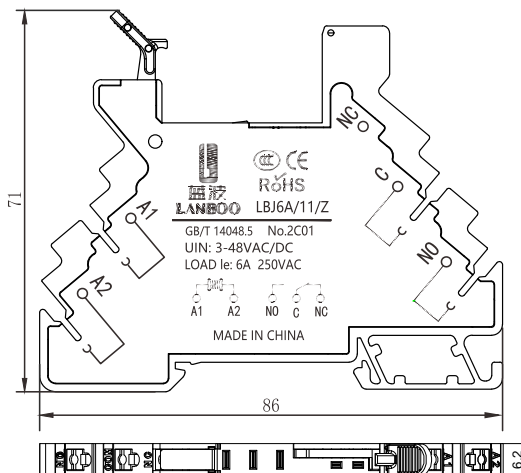
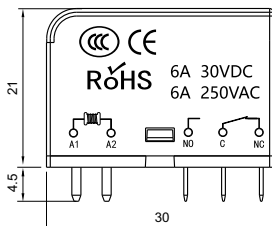

底座专用跨接条
connection strap

LBJ13A

窄款继电器系列

Narrow type Relay

Ith:15A

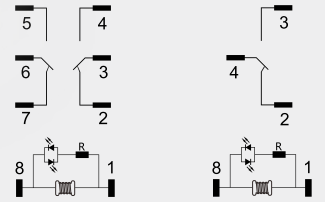
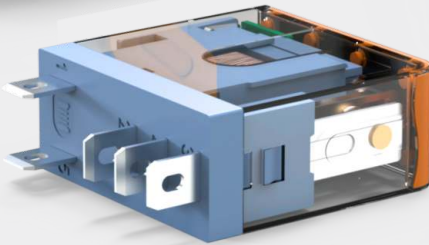
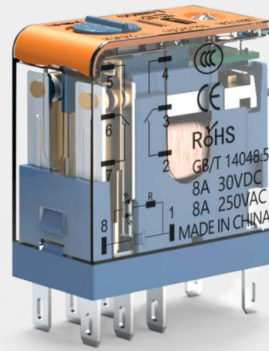
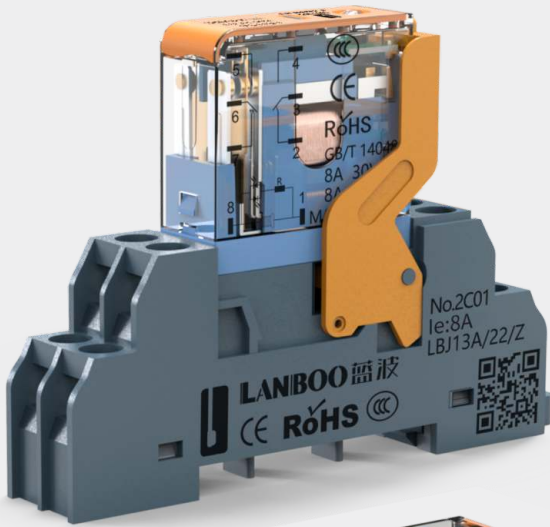

Ith:10A 250VAC

Ith:15A 250VAC



Ith:15A
大电流设计
High-Current



≤25ms
高灵敏度
High Sensitivity



≤50mΩ
大银触点
Silver contact



1000万次
机械寿命
Mechanical Life



底座V0
耐温阻燃
Anti-laminar



-40~80°C
环境耐温强
Environment



≥1000MΩ
绝缘耐压
Insulation



CCC CE RoHS
多项认证
Certificate



银触点,大电流
Silver contact, High Current

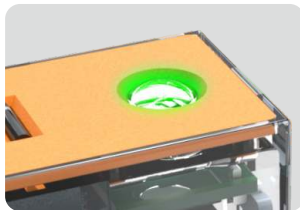

带指示灯
With LED



带测试扳手
Test wrench

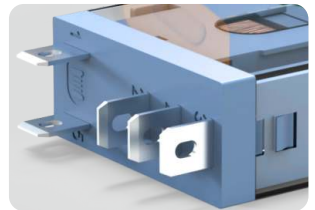

加粗插脚
Bold pin

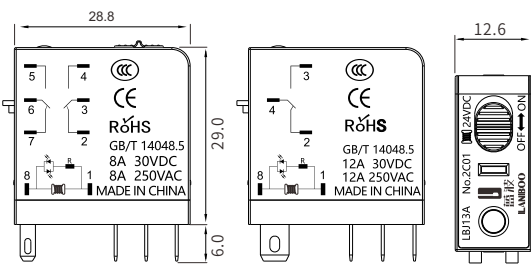

8脚款
8-Pin

5脚大电流款
5-Pin high current

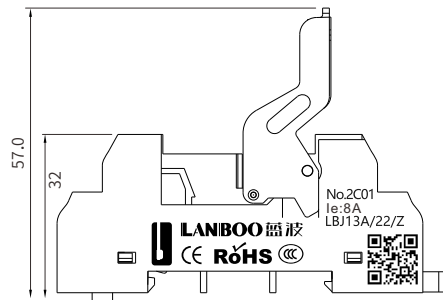

8脚款底座
8-Pin base

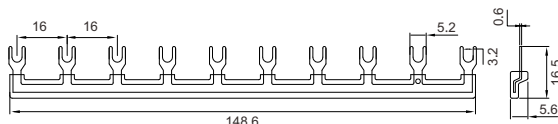
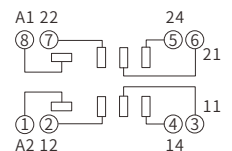

专用跨接条
Dedicated Jumper Bar

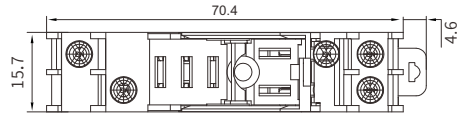

5脚大电流款底座
5-Pin high current base

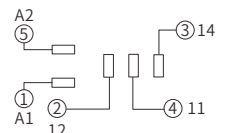

Relay

大电流汽车继电器系列
High Power Automobile Relay

30~200A



汽车继电器命名规则 Automobile relay Naming Rules

LB-■/□/△/★/◇/◆/※

其它备注: 定制符号、防水要求、特殊颜色要求等

Other remarks: customized symbols, waterproof requirements, special color requirements, etc

备注: 铁背款、光背款

Remarks: Iron back style, light back style

触点负载电流: 30A、40A、80A、120A、150A、180A、200A

Contact load current: 30A, 40A, 80A, 120A, 150A, 180A, 200A

线圈电压: 12V、24V、36V、48V、60V、72V

Coil voltage: 12V, 24V, 36V, 48V, 60V, 72V

脚位数量: 4P、5P

Number of pin positions: 4P, 5P

接线柱规格: M6

Terminal specification: M6

继电器代码: JD1912、C150、D120、D200、E150

Relay Code: JD1912, C150, D120, D200, E150

蓝波代号

LANBOO Code

LB-JD

大电流汽车继电器系列
High Power Automobile Relay
30~80A



- 30 公共脚位 30 public pin
- 85 86 线圈脚位 85 86 Coil pin position
- 87 常开脚位 87 Normally open foot position
- 87a 常闭脚位 87a Normally closed foot position



4脚/一常开
带保险丝款
4-pin/1 normally
open fused version



4脚/一常开
4-pin/1 normally open



5脚/一常开一常闭
5-pin/1 normally open
and 1 normally closed

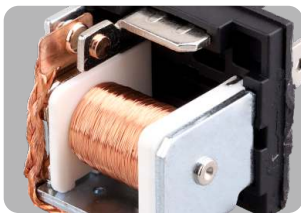

真材实料
Real Stuff



大银触点
Big Silver Contact



专用插件,阻燃耐温
Connector

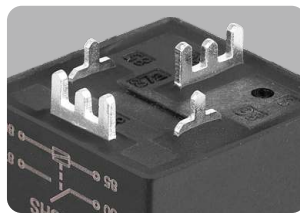

PCB焊接款,镀银插脚
PCB

30A保险丝款

30A fuses

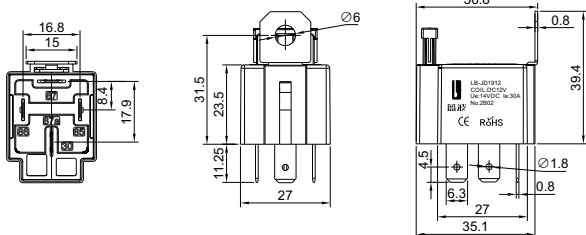

30A光背款

30A light back

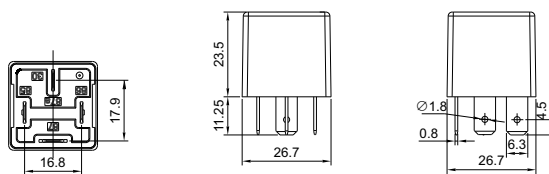

30A铁背款

30A Iron back

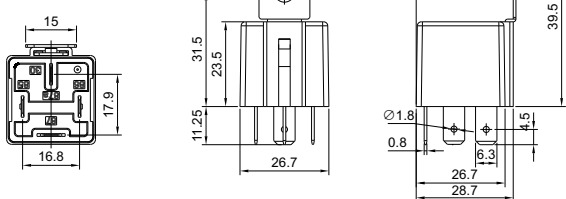

40/80A光背款

40A/80A light back

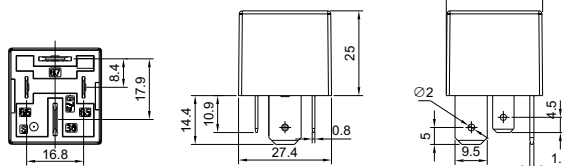

40/80A铁背款

40A/80A Iron back

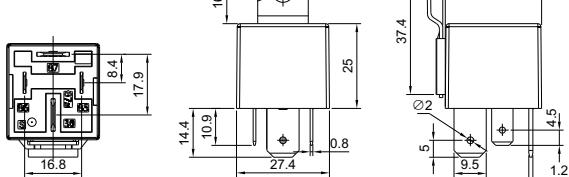

80A PCB焊接脚款

80A PCB Welding pin

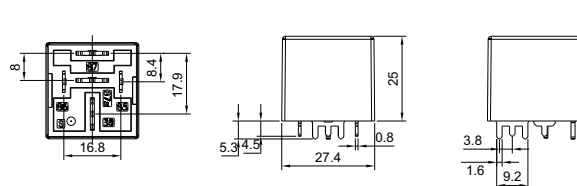

LB-C/D/E

大电流汽车继电器系列
High Power Automobile Relay

120~200A



30~200A
高功率
High-Current



≤25ms
高灵敏度
High Sensitivity



≤50mΩ
大银触点
Silver Contact



1000万次
机械寿命
Mechanical Life



V0
耐温阻燃
Anti-laming



-40~85℃
环境耐温强
Environment



≥100MΩ
绝缘耐压
Insulation



CE RoHS
多项认证
Certificate

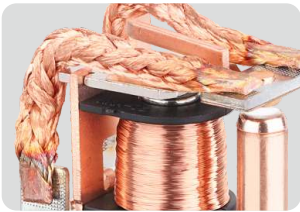

真材实料
Real Stuff

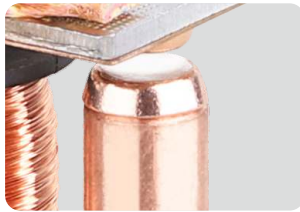

大银触点
Big Silver Contact



螺丝柱接线
Screw connection



阻燃耐温
Flame Retardant

LB-D120/D200

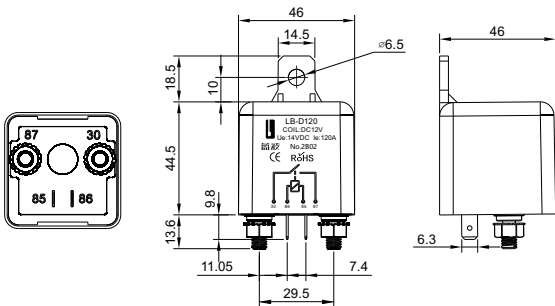

LB-E150

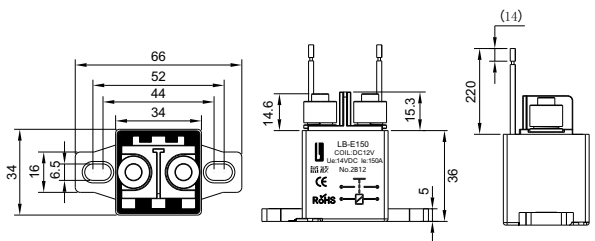

LB-C150A

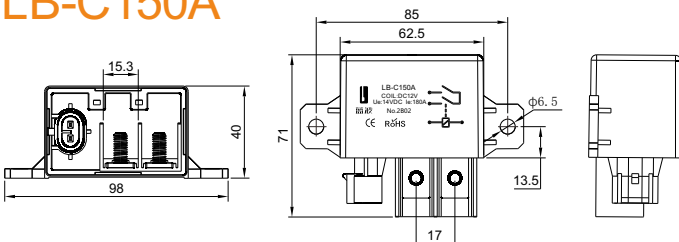

LB-SGQ

可调频闪光器
FM Flasher

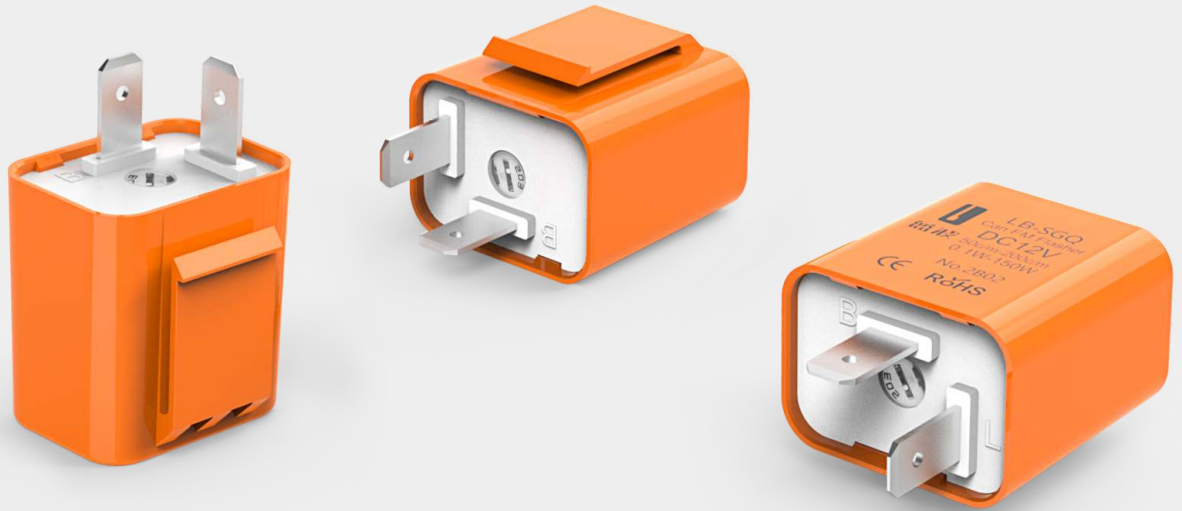

12A/12VDC
触点负载
High-Current



50-200C/m
闪光频率
Flash Rate



12VDC
额定电压
Rated Voltage



150W
最大功率
Insulation



400小时
电气寿命
Electric Life



-40~80°C
环境耐温强
Environment



V0
耐温阻燃
Antif Laming



CE RoHS
多项认证
Certificate



可调频
Can FM



镀银插脚
Silver plated pin



挂钩设计
Hook design

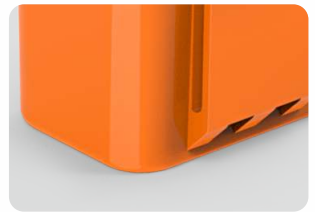

V0阻燃外壳
Inflaming Retarding

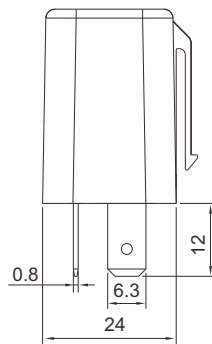
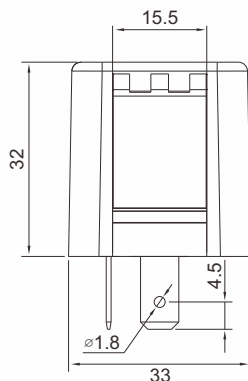
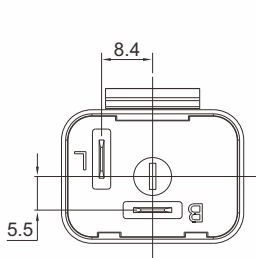

金属船型开关系列

Metal Rocker Switch Series



金属船型开关命名规则 Rocker Switch Naming Rules

LBCX□/★※■/▲▼/◎/※

其它备注: 定制符号、防水要求、特殊颜色要求等

Other remarks: customized symbols, waterproof requirements, special color requirements, etc

上罩和翘板材质: N-镀铬(高配) PC-黑色塑料

Upper cover and rocker material: N-chrome plated (high-end) PC black plastic

带灯电压: 3-8V/25-48V/110V为定制电压 5(9)-24V/220V(250V)常规电压

Voltage with lamp: 3-8V/25-48V/110V is customized voltage 5(9)-24V/220V(250V), conventional voltage

发光颜色: R-红 G-绿 B-蓝 Y-黄 1409、16、20、2810.5只做 R-红 G-绿

Glow color: R-red G-green B-blue Y-yellow; 1409、16、20、2810.5 only R-red G-green

档位: 2-2档 3-3档

Glow color range: 2-2nd gear, 3-3rd gear

开关组合: 10-1NO 20-2NO 11-1NO1NC 22-2NO2NC

Switch combination: 10-1NO 20-2NO 11-1NO1NC 22-2NO2NC

面板材质: H-黑色 J-金色 Y-银色

Panel material: H-Black J-Gold Y-silvery

开孔尺寸: 1409、16、20、2810.5、2822 (mm)

Hole size: 1409、16、20、2810.5、2822 (mm)

船型开关代码

Rocker Switch Code

蓝波代码

LANBOO Code

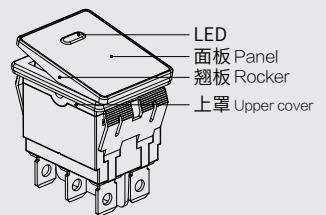

注: 开孔外形尺寸后面用“-”隔开, ※档位、▼带灯电压后面需要用“/”隔开; 不带灯的无需填写▲发光颜色、▼带灯电压。

开关组合 1NO 和 1NC 只能做不带灯。

例: 28*22 外形、黑色面板、2NO、2档、蓝色、24V、镀铬上罩、

对应型号: LBCX2822/H2O2/B24V/N(L)

Note: The outer dimensions of the opening should be separated by "-", and the positions ※ and ▼ with lamp voltage should be separated by "/"; For those without lights, there is no need to fill in ▲ luminous color and ▼ voltage with lights. Switch combinations 1NO and 1NC can only be used without lights. Example: 28 * 22 appearance, black panel, 2NO, 2nd gear, blue, 24V, chrome plated upper cover.

Corresponding model: LBCX2822/H2O2/B24V/N(L)

LBCX16

迷你圆形船型开关
Mini Rocker Switch
Ith:7A 250VAC



常规电压:5-24V 220V, 定制其它电压
Normal Voltage:5-24V 220V, Customizable Other Voltage
常规颜色:红色、绿色;定制:蓝色、黄色、白色
Normal Color:Red/Green;Customizable:Blue/Yellow/White



Ith:7A
大电流开关
High-Current



2000VAC
高绝缘耐压
High-Insulation



Metal
金属外壳
Metal Shell



50000H
长寿命灯珠
Long Life LED



20万次
机械寿命
Mechanical Life



2档
档位清晰
2 Gears



-40~80°C
环境耐温强
Environment



CCC RoHS REACH CE
专利及认证
Certificate



带指示灯
LED



加粗镀银插脚,触点
Bold Silver Plated Pins, High-Current



数控加工,外观高档
CNC, High-grade

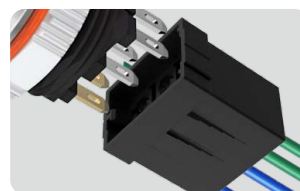

专用接插件
Connector

NO脚蓝线 NO Pin blue line
NC脚黄线 NC Pin yellow line
C公共脚绿线 C Public Pin green line

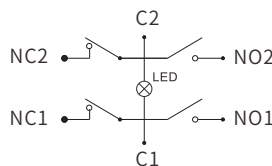
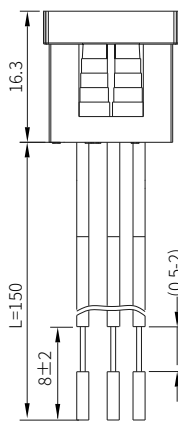
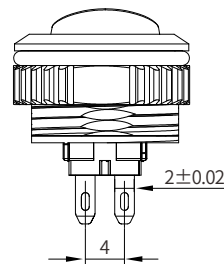
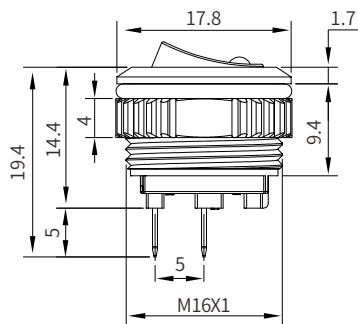
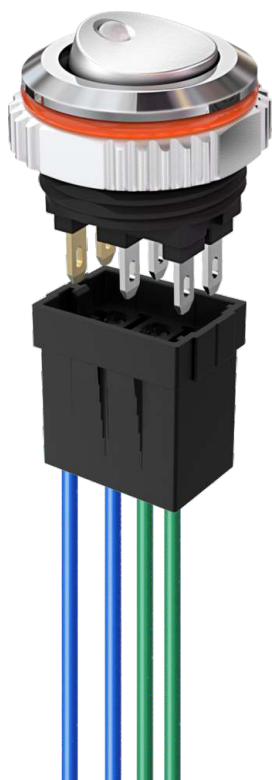

带灯 (2档/6脚)
With LED (2 Gears/6PINS)

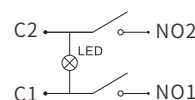

带灯 (2档/4脚)
With LED (2 Gears/4PINS)

0.5mm²国标铜芯线
长度L: 150mm;可定制线长
0.5mm² copper core wire
L: 150mm; length can be customized

此接插件适用于LBCX16、LBCX1409
This connector is suitable for LBCX16 and LBCX1409

LBCX20

船型开关

Rocker Switch
Ith:20A 250VAC



外壳材质: 镀铬, 可定制不锈钢、铝氧化
Material: chrome plating;
Customizable: Stainless steel/Aluminum oxidation
常规电压: 5-24V 250V, 定制其它电压
Normal Voltage: 5-24V 250V, Customizable Other Voltage
常规颜色: 红色、绿色、蓝色; 定制: 黄色、白色
Normal Color: Red/Green/Blue; Customizable: Yellow/White



Ith:20A
大电流开关
High-Current



2000VAC
高绝缘耐压
High-Insulation



Metal
金属外壳
Metal Shell



50000H
长寿命灯珠
Long Life LED



10万次
机械寿命
Mechanical Life



底座V0
耐温阻燃
Antif Laming



-40~80°C
环境耐温强
Environment



CCC RoHS REACH CE
专利及认证
Certificate



H57镀铬外壳, 坚固耐用
H57 chrome plating



H65镀银引脚
Silver tin oxide



LED灯珠, 寿命达50000小时
Momentary with LED

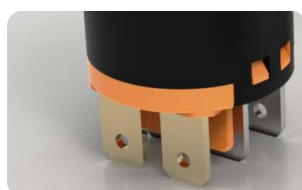

V2级阻燃
Antif Laming

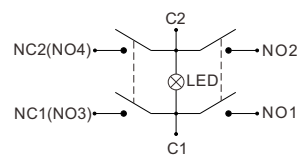
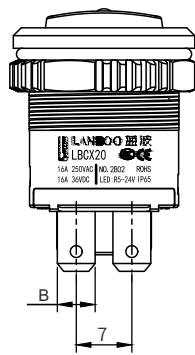
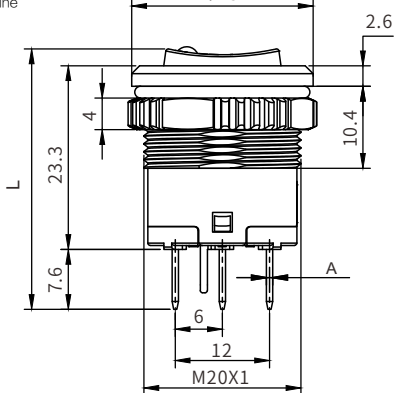
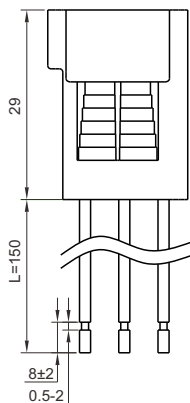
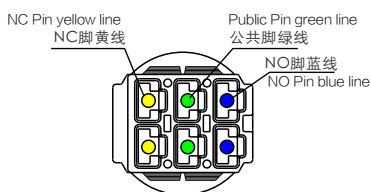

6脚 (3档) 原理图
Schematic diagram of 6-pin (3rd gear)

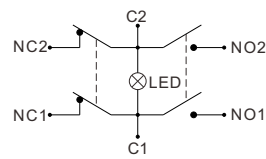

6脚 (2档) 原理图
Schematic diagram of 6-pin (2nd gear)

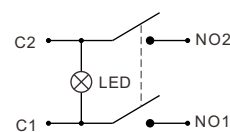

4脚 (2档) 原理图
Schematic diagram of 4-pin (2nd gear)

1.5mm²国标铜芯线

长度L: 150mm; 可定制线长

1.5mm² copper core wire

L: 150mm; length can be customized

型号	L	A	B
LBCX20-Y403	33	6-0.8±0.02	6-4.8±0.05
LBCX20-Y222	34.5	6-0.8±0.02	6-4.8±0.05
LBCX20-Y202	34.5	4-0.8±0.02	4-4.8±0.05

LBCX1409

迷你金属船型开关

Mini Rocker Switch

Ith:10A 250VAC



绚丽黑

土豪金

天山银

低功耗LED: ≤20mA

Low Power Consumption LED: ≤20mA

常规电压: 5-24V 220V, 定制其它电压

Normal Voltage: 5-24V 220V, Customizable Other Voltage

常规颜色: 红色、绿色; 定制: 蓝色、黄色、白色

Normal Color: Red/Green; Customizable: Blue/Yellow/White

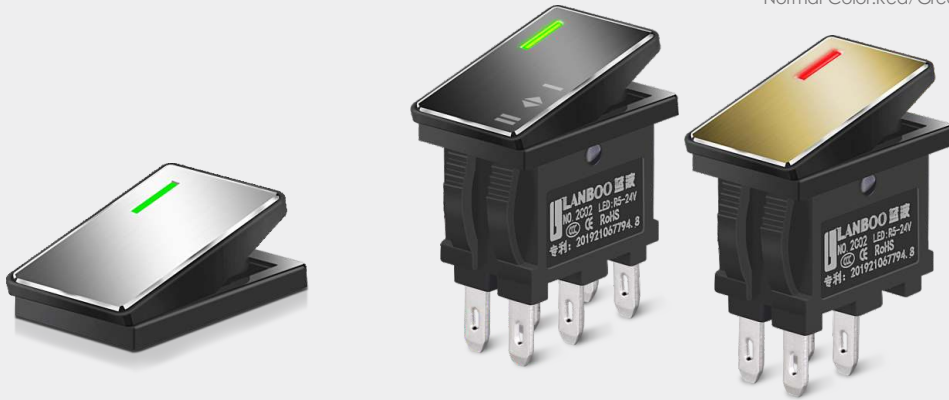

Ith:10A
大电流开关
High-Current



2000VAC
高绝缘耐压
High-Insulation



6063
铝氧化面板
Aluminium Oxidized



50000H
长寿命灯珠
Long Life LED



20万次
机械寿命
Mechanical Life



2/3档
档位清晰
2/3 Gears



-40~80°C
环境耐温强
Environment



CCC RoHS CE
专利及认证
Certificate



3档标识
3 Gears mark



铝铝切割面板,带指示灯
Aluminum Cutting panel,LED



加粗镀银插脚,触点
Bold Silver Plated Pins, High-Current

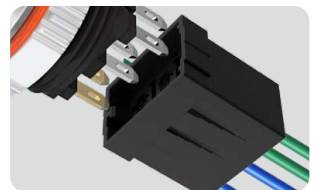

专用接插件
Connector

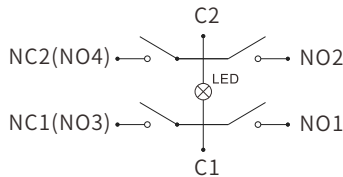
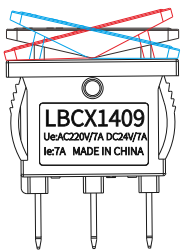

带灯 (3档/6脚)
With LED (3rd gear/6-pin)

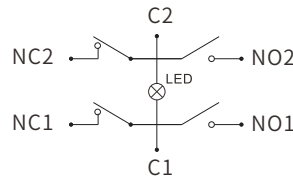

带灯 (2档/6脚)
With LED (2rd gear/6-pin)

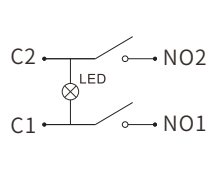

带灯 (2档/4脚)
With LED (2rd gear/4-pin)

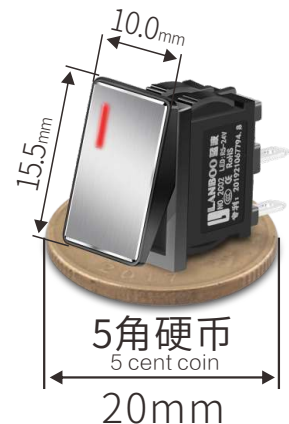
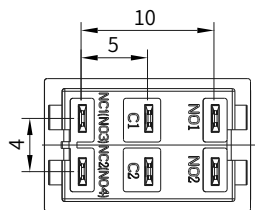
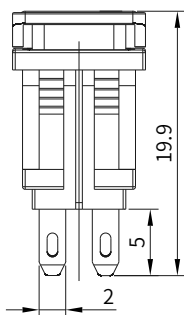
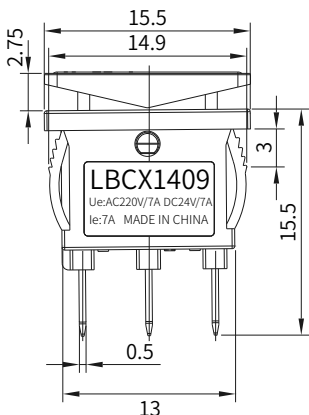

LBCX2810.5 Roker 船型

大电流金属KCD3

High-Current KCD3

Ith: 20A 250VAC

2NO

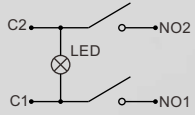

LED发光颜色 LED Color
面板颜色 Panel Color

低功耗LED: $\leq 20\text{mA}$
Low Power Consumption LED: $\leq 20\text{mA}$
常规电压: 9-24V 250V, 定制其它电压
Normal Voltage: 9-24V 250V, Customizable Other Voltage
常规颜色: 红色、绿色; 定制: 蓝色、黄色、白色
Normal Color: Red / Green; Customizable: Blue / Yellow / White

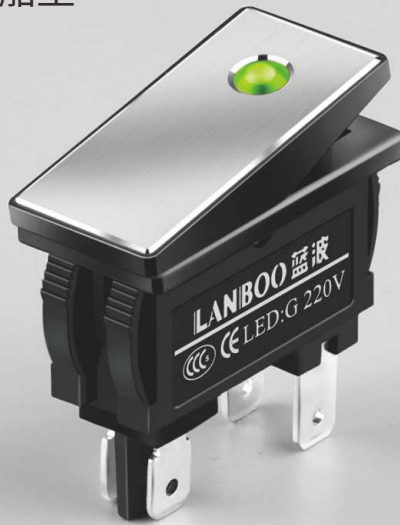

- 20A**
Ith
 大电流开关
High-Current
- 3000VAC**
 高绝缘耐压
High-Insulation
- 6063**
 铝氧化面板
Aluminum Oxidized
- 50000H**
 长寿命灯珠
Long Life LED
- 20万次**
 机械寿命
Mechanical Life
- 底座V0**
 耐高温阻燃
Antif Laming
- 40~80°C**
 环境耐高温强
Environment
- CCC RoHS REACH CE**
 专利及认证
Certificate



铝切割面板,高亮面边框
Aluminum Cutting panel



加粗镀银插脚,触点,大电流
Bold Silver Plated Pins, High-Current



带指示灯
LED



请认准“蓝波”
LANBOO BUTTON

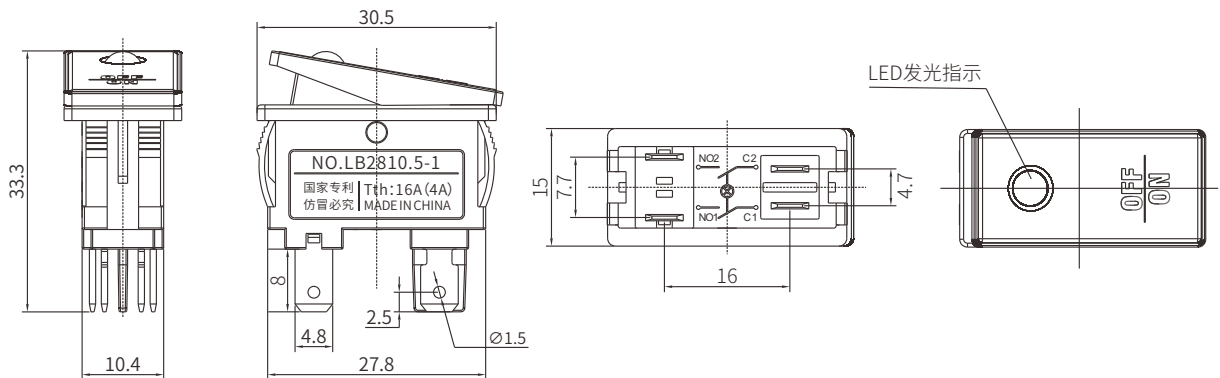

LBCX2822 Roker 船型

大电流金属KCD4

High-Current KCD4

Ith:20A 250VAC

2NO2NC

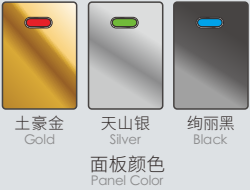
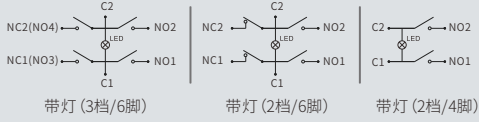

低功耗LED: ≤20mA

Low Power Consumption LED: ≤20mA

常规电压: 9-24V 250V, 定制其它电压

Normal Voltage: 9-24V 250V, Customizable Other Voltage

常规颜色: 红色、绿色; 定制: 蓝色、黄色、白色

Normal Color: Red/Green; Customizable: Blue/Yellow/White



20A

Ith

大电流开关
High-Current



3000VAC

高绝缘耐压
High-Insulation



6063

铝氧化面板
Aluminium Oxidized



LED

50000H
长寿命灯珠
Long Life LED



20万次

机械寿命
Mechanical Life



底座V0

耐温阻燃
Antiflaming



-40~80°C

环境耐温强
Environment



CCC RoHS REACH

专利及认证
Certificate



1. 金属面板
 2. 镀铬翘板
 3. 镀铬上罩
 4. 优质尼龙
1. Metal panel
2. Chrome-Plated
3. Chrome
4. PA66



1. 金属面板
 2. 塑料翘板
 3. 塑料上罩
 4. 一般尼龙
1. Metal panel
2. Plastic
3. Plastic
4. General nylon



2NO脚位
Pin



2NO2NC脚位
Pin

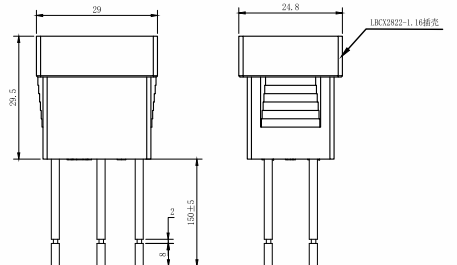
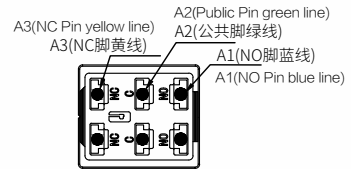
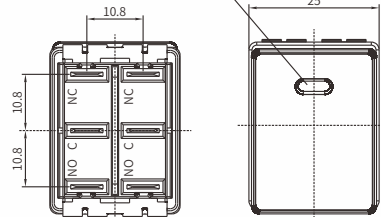
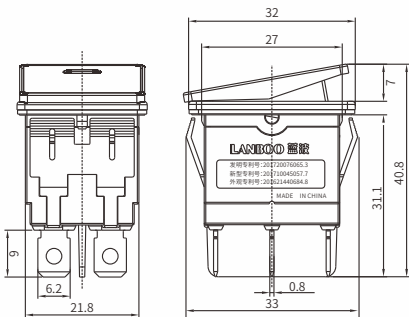

金属按钮、旋钮、钥匙钮、急停钮命名规则

Naming convention for metal buttons, knobs, key buttons and emergency stop buttons

LB \emptyset \diamond - \star \blacklozenge \blacksquare / \odot \blacktriangle \blacktriangledown / \otimes \star / \ast

其它备注: 定制符号、防水要求、特殊颜色要求等
Other remarks: customized symbols, waterproof requirements, special color requirements, etc

接线: J-螺丝脚(蜂鸣器) Wiring: J-screw pin (buzzer)

档位: 2-2档 3-3档 (此选项只针对旋钮及钥匙钮, 其它开关忽略此项)
Gear position: 2- 2nd gear, 3-3rd gear (this option only applies to knobs and key knobs, ignored for other switches)

外壳材质: S-不锈钢 N-镀铬(镀镍) A-铝氧化 PC-塑料 ST-镀钛
Shell material: S-stainless steel N-chromium plated (nickel plated) A-aluminum oxide PC-plastic ST-Titanium plated

带灯电压: 3-8V/25-48V/110V为定制电压 5-24V/9-24V/220V 常规电压
Voltage with lamp: 3-8V/25-48V/110V, customized voltage 5-24V/9-24V/220V, conventional voltage

发光颜色: R-红 G-绿 B-蓝 Y-黄 W-白 O-橙(定制)
Glow color: RG-红绿 RB-红蓝 RG-红绿蓝 RW-红绿白 (注:只有A系列可做双色,三色)
Glow color: RG-red green RB-red blue RG-red green blue RW-red green white (Note: Only the A series can be made in two or three colors)

发光类型: E-环形 E+DY-环环+电源标 DY-电源标 D-点灯 E+XD-环环+小点
Luminous type: E-annular E+DY-annular+Power supply sign DY-Powersupply sign D-Lighting E+XD-annular+Small dots

操作类型: F-自复式 Z-自锁式(保持式) Operation type: F-self resetting Z-self locking (holding)

开关组合: 10-1NO 1C-1NC 11-1NO1NC 20-2NO 22-2NO2NC (NO为常开触点,NC为常闭触点)
Switch combination: 10-1NO 1C-1NC 11-1NO1NC 20-2NO 22-2NO2NC (NO is the normally open contact, NC is the normally closed contact)

头部形状: P-平头 G-高头 Q-球头 Y-钥匙钮 X-旋钮 M-蘑菇头
Head shape: P-Flat head G-High head Q-Ball head Y-Key X-Knob M-Mushroom head

系列号: A[(16A, 19A为1NO1NC,3A);(19A1, 22A, 25A, 30A, 40A)有1NO1NC或2NO2NC可选,3A]
Series number B[(12B,1NO,2A);(16B, 19B,1NO,10A);(22B, 25B,独立1NO1NC,7A)]
C[(22C, 25C,2NO,15A)]
E[(12E,1NO,7A);(16E,1NO,2A);(16E3,1NO,16A);(19E,22E,1NO,16A)]
Y5 (19Y5, 22Y5,1NO1NC或2NO2NC可选,5A,无灯,3A)升级款
X5 (19X5, 22X5,1NO1NC或2NO2NC可选,带灯,3A)升级款
M3(22M3,40mm超大头/1NO1NC,无灯,8A) M4(16 19 22mm,1NO1NC,带灯,3A)
M5.1(19M5.1, 22M5.1,大头,无灯) M5.2(19M5.2, 22M5.2,小头,无灯) M5.4(19M5.4, 22M5.4,带灯)
M6(19M6, 22M6,短款(short),无灯(no LED)) (M5系列均有1NO1NC或2NO2NC可选,3A)
SA-塑料按钮(plastic button) NZ/NZ2-钮子开关(Button switch) QC-轻触(Touch lightly) CM-触摸(Touch)
SM-塑料急停带箭头(Plastic emergency stop with arrow)
SM2-塑料急停带箭头+STOP(Plastic emergency stop with arrow+STOP)
SM3-塑料急停带箭头(Plastic emergency stop with arrow)

安装孔直径(螺纹外径): ϕ 12、 ϕ 16、 ϕ 19、 ϕ 22、 ϕ 25、 ϕ 30、 ϕ 40mm
Installation hole diameter (thread outer diameter): ϕ 12、 ϕ 16、 ϕ 19、 ϕ 22、 ϕ 25、 ϕ 30、 ϕ 40mm
(每个系列里的开孔并不是从 ϕ 12-40mm都有,请参照系列号后括号里的孔径)
(The openings in each series are not derived from ϕ . Available in sizes 12-40mm, please refer to the aperture in parentheses after the serial number)

蓝波代号
LANBOO Code

- 例: 1. 需要16mm开孔、A系列、平头、1NO1NC、自锁、环形、红色发光、LED电压12V、镀铬外壳 对应型号: LB16A-P11Z/ER9-24V/N(L)
1. Requires 16mm opening, A series, flat head, 1NO1NC, self-locking, circular, red emitting, LED voltage 12V, chrome plated shell Corresponding model: LB16A-P11Z/ER9-24V/N(L)
2. 需要22mm开孔、M5.1系列、蘑菇头、2NO2NC、自锁、不锈钢外壳 对应型号: LB22M5.1-M22Z/S/A(L)
2. It needs 22mm opening, M5.1 series, Bowl cut, 2NO2NC, self-locking, stainless steel shell Corresponding model: LB22M5.1-M22Z/S/A(L)
3. 需要19mm开孔、X5系列、旋钮、1NO1NC、LED电压12V、红色发光,保持式、不锈钢外壳、2档 对应型号: LB19X5-X11Z/R5-24V/S/2(L)
3. Requires 19mm opening, X5 series, knob, 1NO1NC, LED voltage 12V, red light emitting, holding type, stainless steel housing, 2nd gear Corresponding model: LB19X5-X11Z/R5-24V/S/2(L)

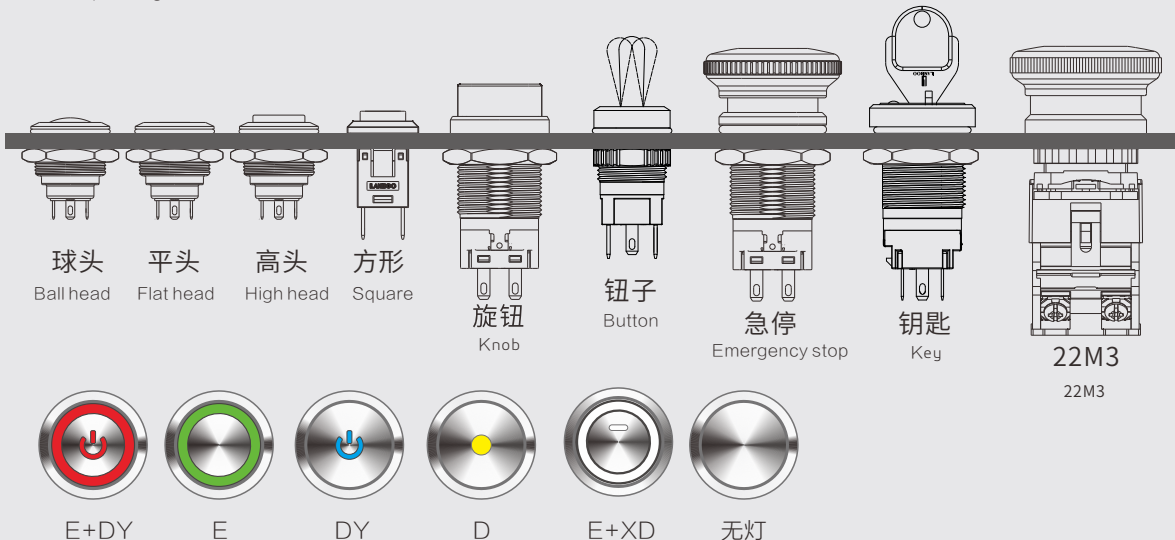

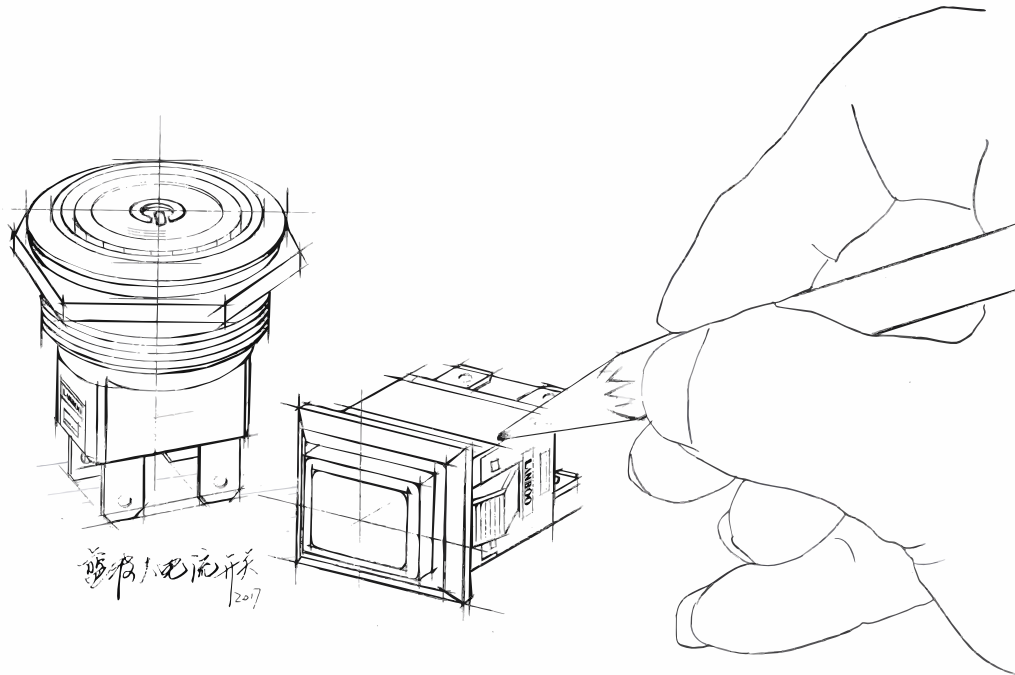

安全大电流按钮开关

Safe & High-Current Push Button Switch

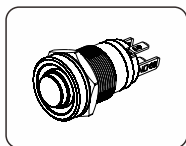

12E/7A Series

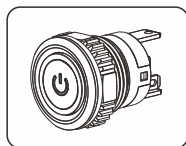

16E3/20A Series

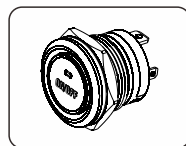

19E/15A Series

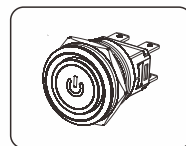

22C/15A Series

一直被模仿,从未被超越
We've been imitated, But never beyond

LB12E High Current

迷你大电流金属按钮

Mini High-Current Button Switch

Ith: 10A 250VAC

1NO



低功耗LED: ≤20mA
Low Power Consumption LED: ≤20mA
常规电压: 5-24V 220V, 定制其它电压
Normal Voltage: 5-24V 220V, Customizable Other Voltage
常规颜色: 红色、绿色、蓝色; 定制: 黄色、白色
Normal Color: Red/Green/Blue; Customizable: Yellow/White

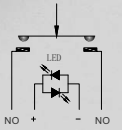

- 10A** Ith 大电流开关 High-Current
- 2500VAC** 高绝缘耐压 High-Insulation
- LED** 50000H 长寿命灯珠 Long Life LED
- 100万次** 机械寿命 Mechanical Life
- V0** 耐高温阻燃 Antif Laming
- 40~80°C** 环境耐温强 Environment
- IP67/IK08** 防水防爆 Protection Level
- CCC RoHS REACH CE UL** 专利及认证 Certificate



凹面头部,方便按压
Concave Head



配套插件
Connector



镀金镀银插脚
Gold/Silver Plated Pins



高亮均匀发光
Even and Soft LED

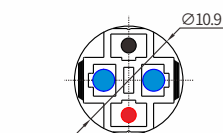
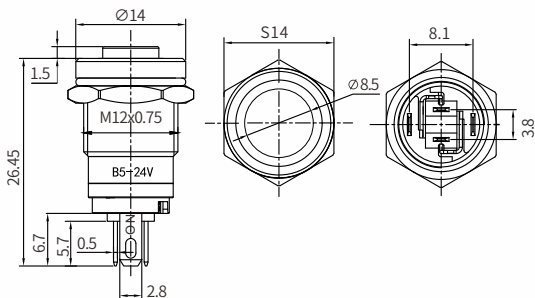

1mm² 蓝色线 Blue Wire (NO)
0.3mm² 黑色线 Black Wire (LED-)
0.3mm² 红色线 Red Wire (LED+)

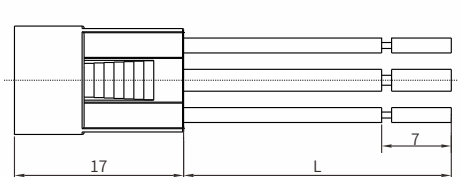

标准线长150mm, 可定做其它尺寸
Wire Length: 150mm, Customize other Sizes

LB16B/19B High Current

大电流金属按钮开关

High-Current Button Switch

Ith:15A 250VAC

1NO



低功耗LED: ≤20mA

Low Power Consumption LED: ≤20mA

常规电压: 9-24V 220V, 定制其它电压

Normal Voltage: 9-24V 220V, Customizable Other Voltage

常规颜色: 红色、绿色、蓝色; 定制: 黄色、白色

Normal Color: Red/Green/Blue; Customizable: Yellow/White

- 
15A
 Ith
 大电流开关
 High-Current
- 
1500VAC
 高绝缘耐压
 High-Insulation
- 
50000H
 长寿命灯珠
 Long Life LED
- 
100万次
 机械寿命
 Mechanical Life
- 
V0
 耐温阻燃
 Antif Laming
- 
-40~80°C
 环境耐温强
 Environment
- 
IP65/IK10
 防水防爆
 Protection Level
- 
CCC RoHS REACH CE
 专利及认证
 Certificate



柔光光圈, 长寿命LED
Soft Light Aperture



高精数控, 精致美观
Seiko CNC



专用插件, 阻燃耐温
Connector



加大银触点, 粗脚, 电流大
Big Silver Contact

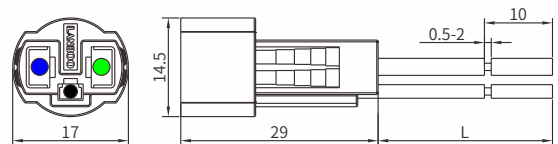
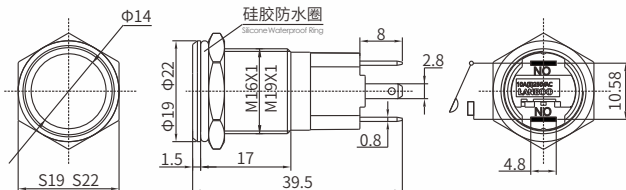

● 蓝色和 ● 绿色NO线为1mm², ● 黑色灯脚线0.5mm², 线长150mm, 可定做其它线长。
Blue and Green NO wire 1mm², Black LED wire 0.5mm², Wire Length: 150mm, Customize other sizes.

LB16E3 Short Large current

迷你短款大电流金属按钮

Mini Short-lagre Current Button Switch
Ith:20A 250VAC

1NO



低功耗LED: ≤20mA
Low Power Consumption LED: ≤20mA
常规电压: 5-24V 220V, 定制其它电压
Normal Voltage: 5-24V 220V, Customizable Other Voltage
常规颜色: 红色、绿色、蓝色; 定制: 黄色、白色
Normal Color: Red/Green/Blue; Customizable: Yellow/White

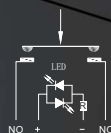

- 20A** Ith 大电流开关 High-Current
- 短** 23mm 短款设计 Short Design
- 4000米** 适合海拔 Long Life LED
- 50万次** 机械寿命 Mechanical Life
- V0** 连接端耐温阻燃 Antif Laming
- 40~80°C** 抗耐温范围 Environment
- IP66/IK08** 防水防尘 Protection Level
- CCC RoHS REACH UL** 专利及认证 Certificate



凹面头部,方便按压
Concave Head



配套插件
Connector



镀银长插脚
Silver Long Plated Pins



高亮均匀发光
Even and Soft LED

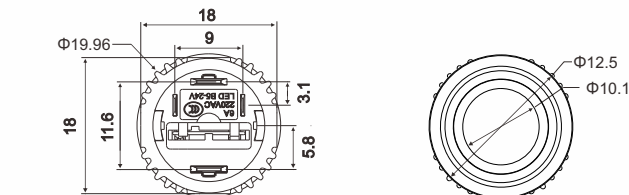
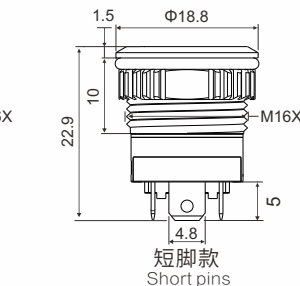
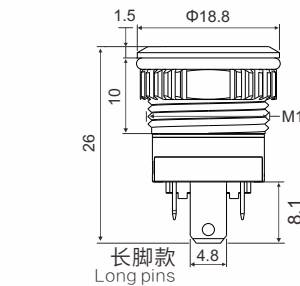

短脚无接插件
Short pin without connector

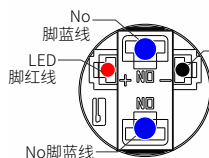

1mm² 蓝色线 Blue Wire (NO)
0.3mm² 黑色线 Black Wire (LED-)
0.3mm² 红色线 Red Wire (LED+)

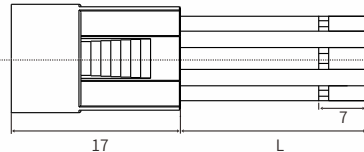

标准线长150mm, 可定做其它尺寸
Wire Length: 150mm, Customize other Sizes

LB19E/22E Short 短款

大电流金属按钮开关

High-Current Short Switch

Ith:20A 250VAC

1NO

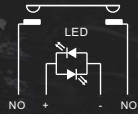

红色 Red 绿色 Green 蓝色 Blue 黄色 Yellow 白色 white

低功耗LED: ≤20mA

Low Power Consumption LED

常规电压: 5-24V 220V, 定制其它电压

Normal Voltage: 5-24V 220V, Customizable Other Voltage

常规颜色: 红色、绿色、蓝色; 定制: 黄色、白色

Normal Color: Red/Green/Blue; Customizable: Yellow/White

总长23.2mm



20A

Ith

大电流开关
High-Current



2500VAC

高绝缘耐压
High-Insulation



50000H

长寿命灯珠
Long Life LED



100万次

机械寿命
Mechanical Life



V0

耐高温阻燃
Anti-laminating



-40~80°C

环境耐温强
Environment



IP67/IK10

防水防爆
Protection Level



CCC RoHS REACH CE UL

专利及认证
Certificate



凹面大按键, 贴合手指
Easy to Press



无极LED灯珠, 大触点
Non-Polar LED



加粗镀金脚, 可拆锁扣
Thick Gold Plated



专用接插件
Connector

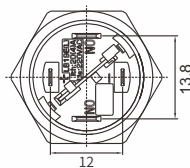
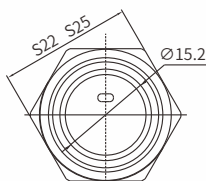

短脚款
Short pins

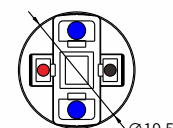

长脚插件款
Long leg plug-in model

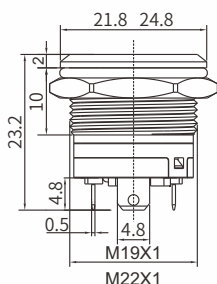
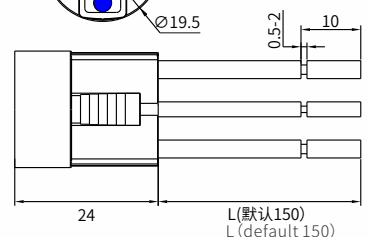

短脚款

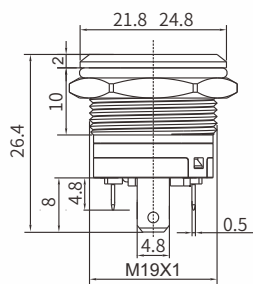

长脚款

● 红色和● 黑色灯脚线0.5mm², ● 蓝色NO负载线1.5mm²
线长150mm, 可定做其它线长
Red and Black LED wire 0.5mm², Blue NO wire 1.5mm²
Wire Length: 150mm, Customize other sizes.

LB22/25C High Current

大电流金属按钮开关

High-Current Button Switch

Ith:20A 250VAC

2NO



低功耗LED: ≤20mA
Low Power Consumption LED: ≤20mA
常规电压: 9-24V 220V, 定制其它电压
Normal Voltage: 9-24V 220V, Customizable Other Voltage
常规颜色: 红色、绿色、蓝色; 定制: 黄色、白色
Normal Color: Red / Green / Blue; Customizable: Yellow / White

- 20A**
Ith
大电流开关
High-Current
- 3000VAC**
高绝缘耐压
High-Insulation
- 50000H**
长寿命灯珠
Long Life LED
- 100万次**
机械寿命
Mechanical Life
- V0**
耐温阻燃
Anti Flaming
- 40~80°C**
环境耐温强
Environment
- IP67/IK10**
防水防爆
Protection Level
- CCC RoHS REACH CE UL**
专利及认证
Certificate



凹面设计, 贴合手指
Concave Design / Easy to press



加粗镀银插脚, 大电流
Bold Silver plated Pins, High-Current



可配插件, 塑料件均阻燃
Connector

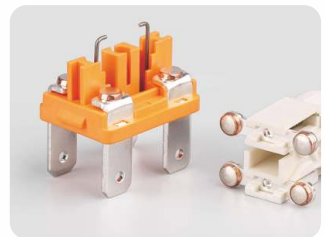

加大银点, 双锁钩
Bold Silver Contact

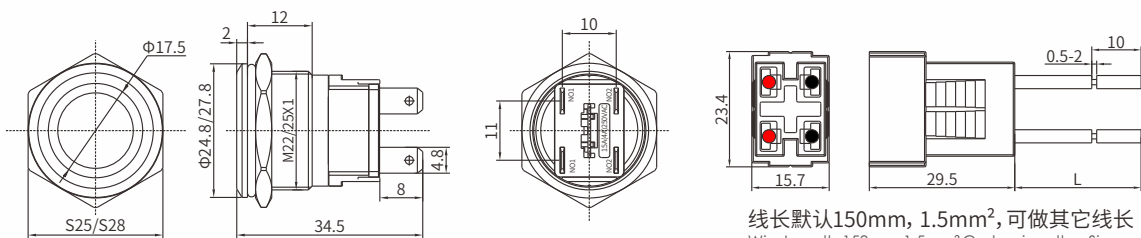

线长默认150mm, 1.5mm², 可做其它线长
Wire Length: 150mm, 1.5mm² Customize other Sizes

LB1913 Square Button

方形按钮

方形大电流金属按钮

Square High-Current Button

Ith:20A 250VAC

2NO

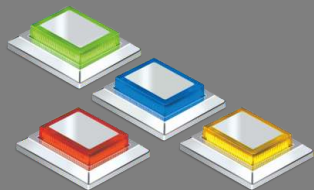
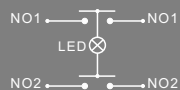

低功耗LED: $\leq 20\text{mA}$

Low Power Consumption LED: $\leq 20\text{mA}$

常规电压: 9-24V 220V, 定制其它电压

Normal Voltage: 9-24V 220V, Customizable Other Voltage

常规颜色: 红色、绿色、蓝色; 定制: 黄色、白色

Normal Color: Red/Green/Blue; Customizable: Yellow/White

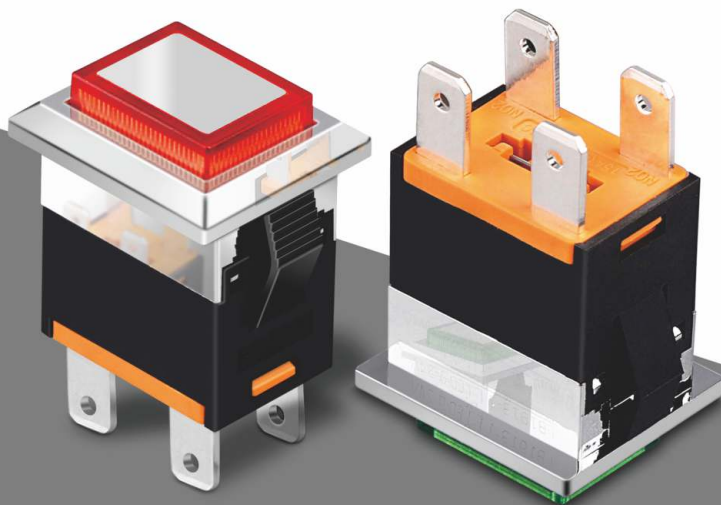

20A

Ith

大电流开关
High-Current

3000VAC

高绝缘耐压
High-Insulation

Metal

不锈钢按键
Stainless Steel Key

LED

50000H

长寿命灯珠
Long Life LED

20万次

机械寿命
Mechanical Life

V0

耐温阻燃
Anti-f Laming

-25~55°C

环境耐温强
Environment

CCC RoHS REACH CE

专利及认证
Certificate

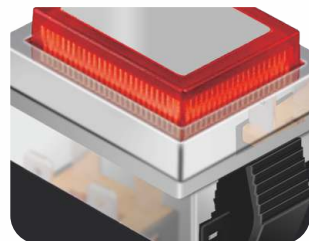

不锈钢按键, 镀铬头部
Stainless Steel Key



加粗镀银插脚
Silver Plated Pins

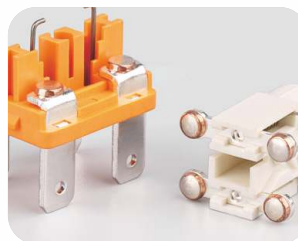

4颗加粗银触点
Silver Contact



专用接插件
Connector

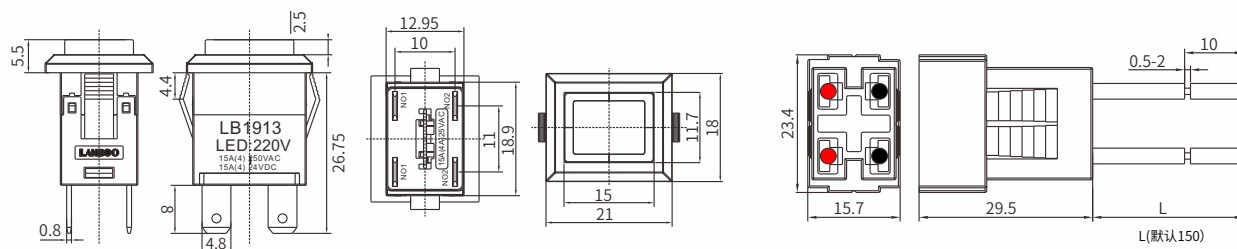

接插件线长默认150mm, 1.5mm², 可做其它线长
Wire Length: 150mm, 1.5mm² Customize other Sizes

LB16-40A Series

Monochrome/Bi-color/Tri-color LED
IP67/可做双色、三色发光

1NO1NC 2NO2NC

Ith:5A 250VAC

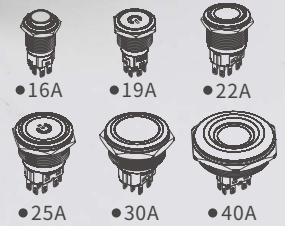
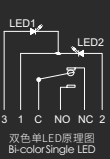
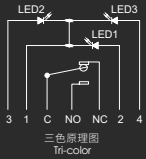
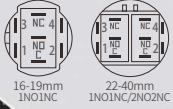

RGB
可做双色三色
Bi-color Tri-color



<50mΩ
快动高灵敏
Contactsensitive



50000H
长寿命灯珠
Long Life LED



100万次
机械寿命
Mechanical Life



底座V0
耐温阻燃
Antif Laminar



-40~80℃
环境耐温强
Environment



IP67/IK10
防水防爆
Protection Level



CCC RoHS REACH CE TUV CE_{roHS} CB_{roHS}
专利及认证
Certificate



•16A(16mm)



•19A(19mm)



•22A(22mm)



•25A(25mm)



•30A(30mm)



•40A(40mm)



高亮无极宽电压LED Long Life/Wide Voltage LED

低功耗LED: ≤20mA
Low Power Consumption LED: ≤20mA

常规电压: 9-24V 220V, 定制其它电压
Normal Voltage: 9-24V 220V, Customizable Other Voltage

常规颜色: 红色、绿色、蓝色; 定制: 黄色、白色、双色、三色
Normal Color: Red/Green/Blue; Customizable: Yellow/White/Bi-color/Tri-color



头部防水IP67
Waterproof IP67



配套专用插件
Connector



镀金/银插脚/银触点
Silver/Gold Pins/Contact



定制外壳颜色
Custom Shell color

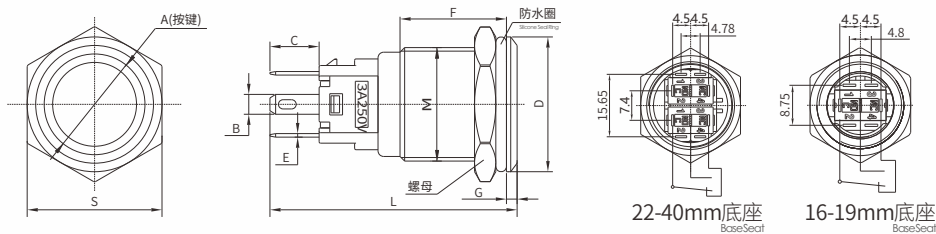

型号/Model	Size 尺寸	S	A	B	C	E	F	L	G	D	M	触点类型/Contact
LB16A	S19	Ø14	2.8	7	0.5	15	34.8	1.5	Ø19	M16X1	1NO1NC	
LB19A	S22	Ø17	2.8	7	0.5	15	34.8	1.5	Ø22	M19X1	1NO1NC	
LB22A	S25	Ø18	2.8	7	0.5	15	35	1.5	Ø25	M22X1	1NO1NC/2NO2NC	
LB25A	S28	Ø22	2.8	7	0.5	15	35	1.5	Ø28	M25X1	1NO1NC/2NO2NC	
LB28A	S31	Ø22	2.8	7	0.5	15	35	1.5	Ø31	M28X1	1NO1NC/2NO2NC	
LB30A	S34	Ø22	2.8	7	0.5	15	35	1.5	Ø33	M30X1	1NO1NC/2NO2NC	
LB40A	S45	Ø22	2.8	7	0.5	15	35	1.5	Ø43	M40X1	1NO1NC/2NO2NC	

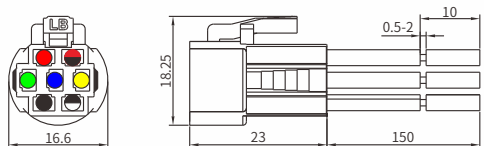

LB16A LB19A (1NO1NC)

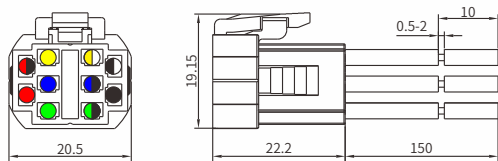

LB22A LB25A LB28A LB30A LB40A

●● 灯脚线 ●● 双色或三色灯脚线 ●● NC线 ●● NO线 ●● C脚进线

使用0.5mm²电线, 线长150mm, 可定做其他规格线长
Wire Length: 150mm、0.5mm², Customize other Sizes

LB19A1 Series

1NO1NC/2NO2NC

Ith:5A 250VAC

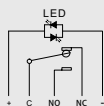

无灯 环形灯 环形+电源
Without Ring LED Ring+Power Symbol



红色 绿色 蓝色 黄色 白色
Red Green Blue Yellow White

低功耗LED: ≤20mA

Low Power Consumption LED: ≤20mA

常规电压: 5-24V 220V, 定制其它电压

Normal Voltage: 5-24V 220V, Customizable Other Voltage

常规颜色: 红色、绿色、蓝色; 定制: 黄色、白色

Normal Color: Red/Green/Blue; Customizable: Yellow/White



2500VAC
高绝缘耐压
High-Insulation



<50mΩ
快动高灵敏
Contactsensitive



50000H
长寿命灯珠
Long Life LED



100万次
机械寿命
Mechanical Life



V2
耐温阻燃
Anti Lamming



-40~80°C
环境耐温强
Environment



IP65/IK10
防水防爆
Protection Level



RoHS REACH CE TUV CE(TUV) CB(TUV)
专利及认证
Certificate



可做2常开2常闭
2NO2NC



专用插件,防误碰设计
Connector

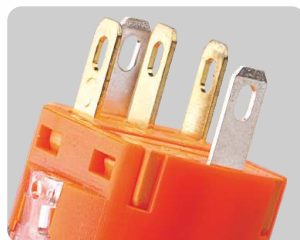

镀金银插脚,银触点
Gold Pins/Silver Contact



头部防水,高亮LED
Head Waterproof

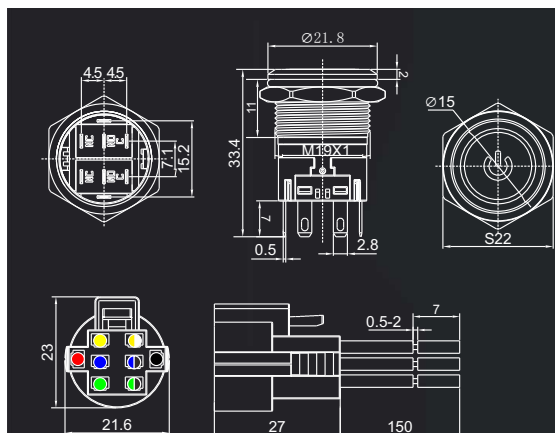

○●灯脚线 ○●NC线 ○●NO线 ○●C脚进线

使用0.5mm²电线, 线长150mm, 可定做其他规格线长
Wire Length: 150mm, 0.5mm², Customize their Sizes



LB12/B16E Short 短款

Short-Length Series

Ith:3A 250VAC

1NO



低功耗LED: ≤20mA

Low Power Consumption LED: ≤20mA

常规电压: 5-24V 220V, 定制其它电压

Normal Voltage: 5-24V 220V, Customizable Other Voltage

常规颜色: 红色、绿色、蓝色; 定制: 黄色、白色

Normal Color: Red/Green/Blue, Customizable: Yellow/White



头部及外壳可做氧化彩色
Head and shell can be oxidized color



总长: 21.3mm

- 
21.3mm
 精致短款
 Delicate
- 
RGBY
 彩色氧化头部
 Oxidized Color
- 
50000H
 长寿命灯珠
 Long Life LED
- 
100万次
 机械寿命
 Mechanical Life
- 
底座V0
 耐高温阻燃
 Antif Laming
- 
-40~80°C
 环境耐温强
 Environment
- 
定制1500VAC
 高绝缘耐压
 High-Insulation
- 
CCC RoHS REACH CE
 专利及认证
 Certificate



12mm

小巧精致, 可配接插件
Small and Beautiful



16mm

自复/自锁-1NO
Momentary/Latching-1NO



氧化彩色头部及外壳
Can be oxidized color



柔和高亮LED, 长寿命
Soft and bright Long-Life LED

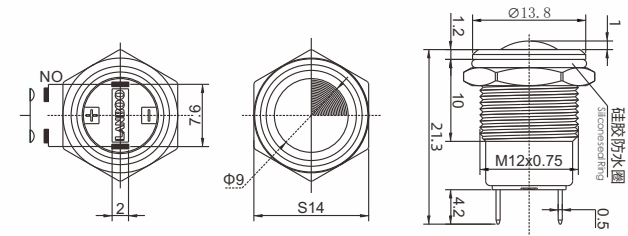

12B外形尺寸
Outline Dimension

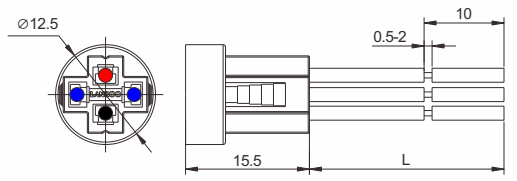

● 0.3mm² (NO) ●● 0.3mm² (LED±)
 使用0.3mm²电线, 线长150mm, 可定做其他规格线长
 Wire Length: 150mm 0.3mm², Customize other Sizes

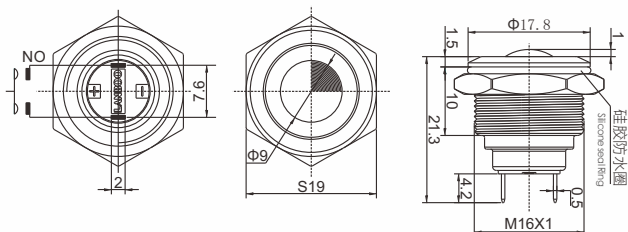

16E外形尺寸
Outline Dimension

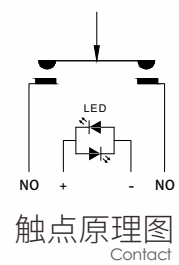

触点原理图
Contact

LB22B/25B NEW 升级款

大电流金属按钮开关

High-Current Button

Ith:10A 250VAC

1NO1NC

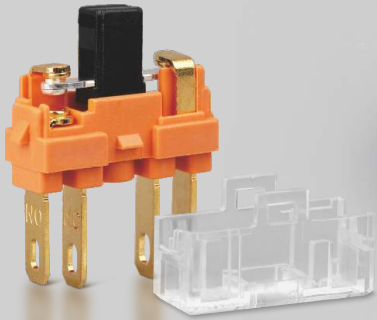

大电流微动开关
High Current MicroSwitch

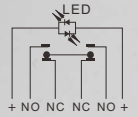

- 
10A
Ith
 大电流开关
High-Current
- 
2000VAC
 高绝缘耐压
High-Insulation
- 
50000H
 长寿命灯珠
Long Life LED
- 
100万次
 机械寿命
Mechanical Life
- 
底座V0
 耐高温阻燃
Antif Laming
- 
-40~80°C
 环境耐温强
Environment
- 
IP67/IK10
 防水防爆
Protection Level
- 
CCC RoHS REACH CE
 专利及认证
Certificate



可视化窗口,科技感十足
Visual Window

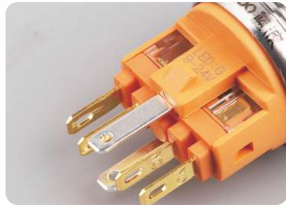

镀金/镀银插脚,导电性好
Silver/Gold Plated Pins

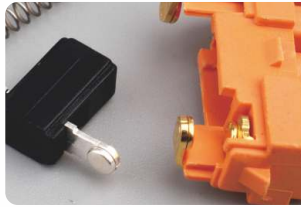

加粗触点,通过电流更大
Big Contact



柔和高亮LED
Soft And High Lighted LED

- 
 无灯
Without
- 
 环形灯
Ring LED
- 
 环形+电源
Power Symbol
- 
 红色
Red
- 
 绿色
Green
- 
 蓝色
Blue
- 
 黄色
Yellow
- 
 白色
White

低功耗LED: ≤20mA
 Low Power Consumption LED: ≤20mA
 常规电压: 9-24V 220V, 定制其它电压
 Normal Voltage: 9-24V 220V, Customizable Other Voltage
 常规颜色: 红色、绿色、蓝色; 定制: 黄色、白色
 Normal Color: Red/Green/Blue; Customizable: Yellow/White

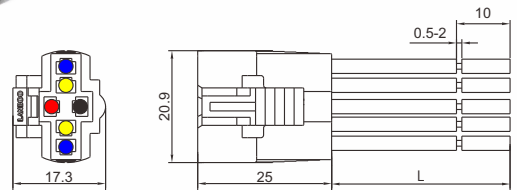
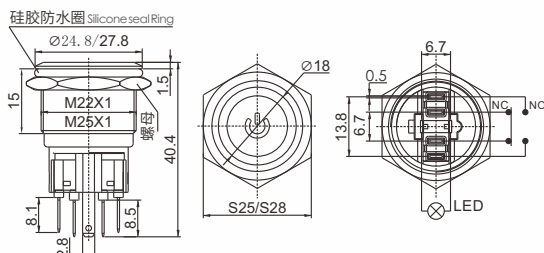
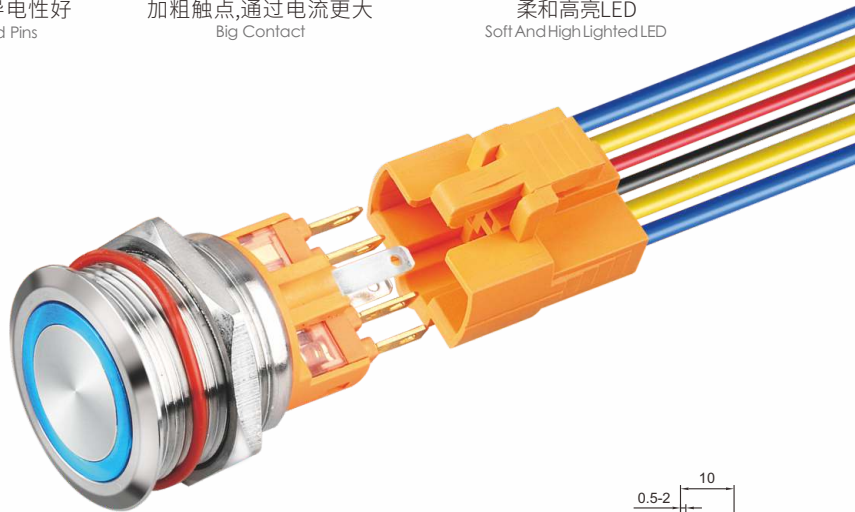

● 灯脚线 ● NC线 ● NO线
 NC NO 使用1mm²电线, LED 0.5mm²电线,
 线长150mm, 可定做其他规格线长
 Wire Length: 150mm、NC NO : 1mm² wire,
 LED: 0.5mm² wire, Customize other Sizes

LB19/22CM TOUCH

1NO大电流双色触摸开关

1NO High-Current Bi-color Touch Switch

Ith:5A 250VAC

IP68

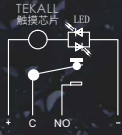

环形灯
Ring LED



环形+电源
Ring+Power Symbol

通电蓝色发光/触摸红色发光

Power-on-Blue/Touch Button-Red

LED长寿命 | 双色指示 | 灯光柔和

LED High Durability | Bi-Color | Lightsoft

输入电压:DC12V DC24V

Input Voltage



5A

Ith

大电流开关

High-Current



RB

红蓝双色指示

Bi-Color



LED

50000H

长寿命灯珠

Long Life LED



10万次

机械寿命

Mechanical Life



V2

耐温阻燃

Anti-flaming



-40~80°C

环境耐温强

Environment



IP68/IK10

防水防爆

Protection Level



CCC RoHS REACH

专利及认证

Certificate



专用插件,卡扣设计
Connector

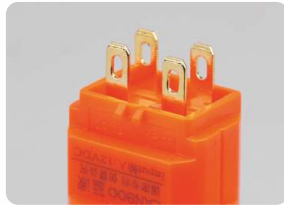

1NO 镀金插脚
1NO Gold-Plated Pins



4芯护套线
4 Core Sheath Wire



氧化黑/不锈钢
Oxidation Black/Stainless Steel

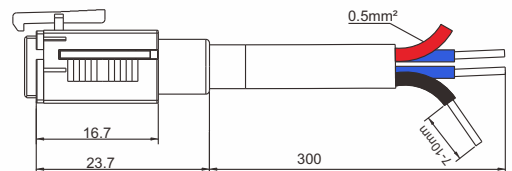
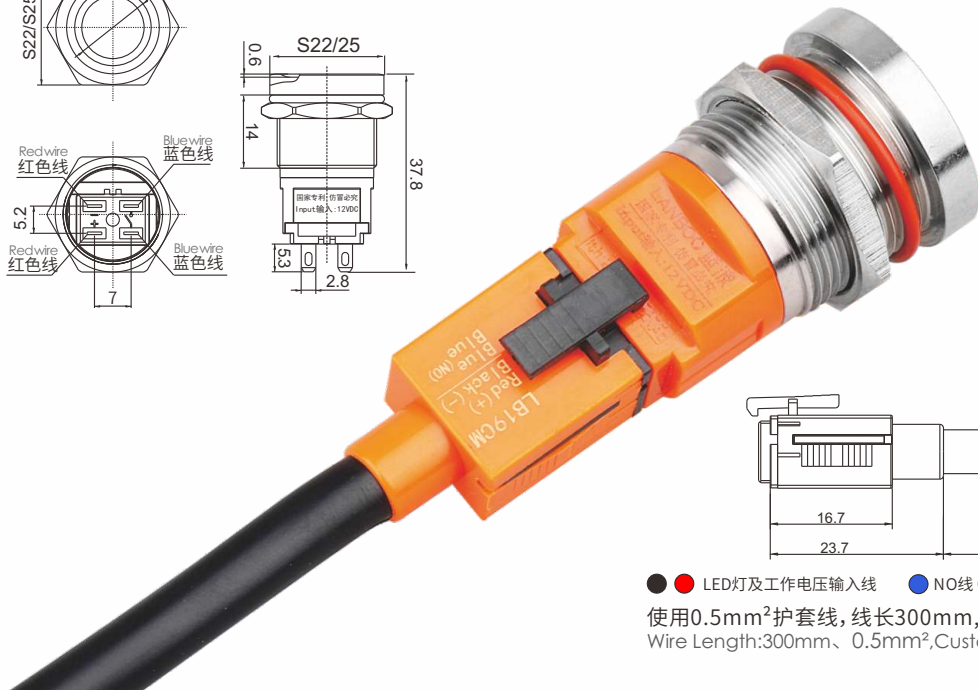
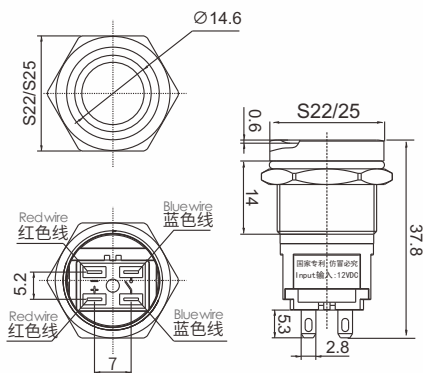

●● LED灯及工作电压输入线 ● NO线 (通电默断开, 触摸后导通, 无源信号)

使用0.5mm²护套线, 线长300mm, 可定做其他规格线长
 Wire Length:300mm、0.5mm²、Customize other Sizes

LB12-22QC Pins 插脚款

Ultra-thin Tact Metal Buttons
超薄款轻触金属开关

Ith:0.5A 250VAC

1NO



低功耗LED: ≤20mA
Low Power Consumption LED ≤20mA
常规电压: 5-24V 220V, 定制其它电压
Normal Voltage: 5-24V 220V, Customizable Other Voltage
常规颜色: 红色、绿色、蓝色; 定制: 黄色、白色
Normal Color: Red / Green / Blue; Customizable: Yellow / White



15mm
超短款
Short



IP68/IK08
防水防爆
Protection Level



50000H
长寿命灯珠
Long Life LED



10万次
机械寿命
Mechanical Life



底座V0
耐温阻燃
Antif Laming



-40~80°C
环境耐温强
Environment



轻触
按压手感好
Convenient press



CCC RoHS REACH CE UL
专利及认证
Certificate



不锈钢外壳
Stainless Steel Shell



请认准“LANBOO”
LANBOO Button

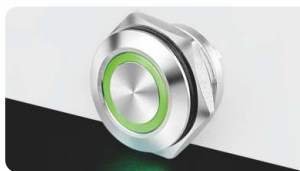

柔和高亮LED, 寿命达50000小时
Momentary With LED



头部防水高达IP68
Head waterproof IP68

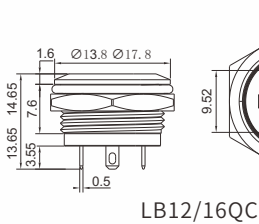

LB12/16QC

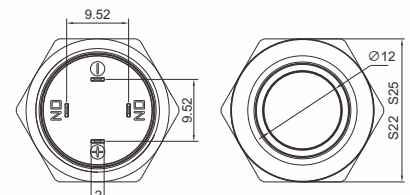
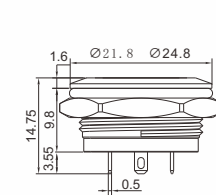
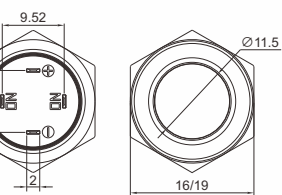

LB19QC LB22QC



蓝波新款
LANBOO New

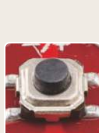

为了提升手感、按压行程、按压声音.....
蓝波工程师为了寻找这颗满意的轻触开关,寻找多家优秀轻触开关厂家还进行无数次的测试。
优点:
1. 独立轻触开关, PCB焊接式, 性能更稳定。
2. 行程略长, 按压手感更好, 有明显按压手感回馈。
3. 声音清脆, 有微动开关的感觉。
4. 接触电阻降低, 符合国家标准。

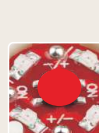

4颗无极长寿命LED灯珠
采用进口LED无极芯片, 采用全自动贴片机焊接。
优点:
1. 无极LED, 不分正负极, 接线方便省事。
2. 进口LED芯片, 亮度高, 寿命长, 色温一致性高。
3. 4颗LED, 整体发光更均匀。
4. 蓝波拥有全自动贴片机, 焊点更美观牢固, 无虚焊。

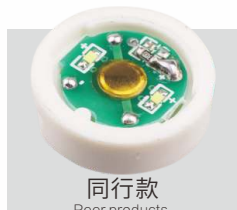

同行款
Peer products



市场款导通部件
胶布粘合固定的不锈钢钢仔片, 有胶布老化导致脱落, 贴歪偏心导致接触不良等.....
缺点:
1. 胶布粘合, 容易老化导致脱落、移位...。
2. 按了没按一样, 无明显手感反馈, 手感无。
3. 电阻大或位置不准造成失灵风险。
4.



2颗分正负极的小灯珠
接线需分辨正负极, 手工焊接....
缺点:
1. 接线需找正负极, 正负容易接反, 浪费时间。
2. 两颗微型灯珠, 发光扩散不均匀。
3. 手工焊接, 容易粘连、虚焊, 可靠性差。
4.

LB16NZ Toggle Switch 钮子开关

Ith:20A/250VAC

1N01NC

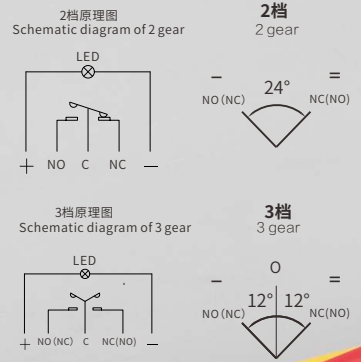

环形灯

Ring LED



红色

Red



绿色

Green



蓝色

Blue



黄色

Yellow



白色

White

低功耗LED: ≤20mA

Low Power Consumption LED: ≤20mA

常规电压: 5-24V 220V, 定制其它电压

Normal Voltage: 5-24V 220V, Customizable Other Voltage

常规颜色: 红色、绿色; 定制: 黄色、白色、蓝色

Normal Color: Red / Green; Customizable: Yellow / White / Blue



Ith:20A
大电流开关
High-Current



大手柄
档位清晰
Big Handle



50000H
长寿命灯珠
Long Life LED



50万次
机械寿命
Mechanical Life



V0
耐温阻燃
Antif Laming



-40~80°C
耐温性能强
Environment



CCC RoHS REACH CE
专利及认证
Certificate



大手柄, 头部CD纹设计
Big handle, Easy Operation

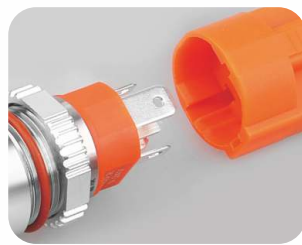

可配专用插件
Connector



银触点, 加粗银插脚
Big Silver Pins



带灯指示
LED

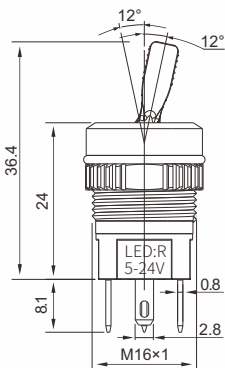

2档
2 gear

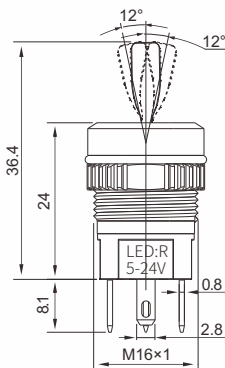

3档
3 gear

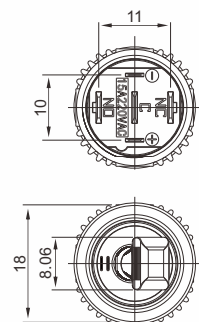
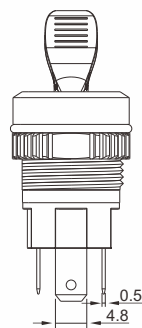

LB16NZ2 Toggle Switch 钮子开关

Ith:20A/250VAC

1NO1NC



环形灯
Ring LED



红色 Red 绿色 Green 蓝色 Blue 黄色 Yellow 白色 White

低功耗LED: ≤20mA

Low Power Consumption LED: ≤20mA

常规电压: 5-24V 220V, 定制其它电压

Normal Voltage: 5-24V 220V, Customizable Other Voltage

常规颜色: 红色、绿色; 定制: 黄色、白色、蓝色

Normal Color: Red/Green; Customizable: Yellow/White/Blue



2档原理图
Schematic diagram of 2 gear

2档
2 gear

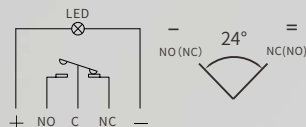

3档原理图
Schematic diagram of 3 gear

3档
3 gear

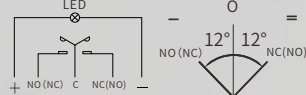

2档
2 gear



3档
3 gear

20A

Ith:20A
大电流开关
High-Current



镀铜镍手柄
稳定耐用
Copper nickel plating
Stable and durable



50000H
长寿命灯珠
Long Life LED



50万次
机械寿命
Mechanical Life



底座V0
耐阻燃
Antiflaming
Environment



-40~80°C
耐温性能强
Environment



CCC RoHS REACH CE
专利及认证
Certificate

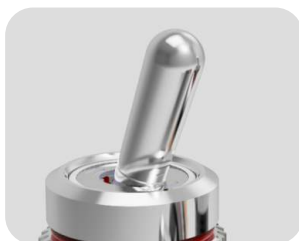

铜镀镍手柄
Copper nickel plating



V0级阻燃底座
Flame retardant base



H65镀银引脚
Silver tin oxide



带灯指示
LED

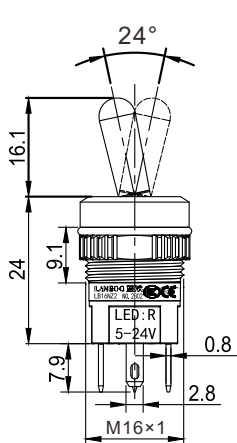

2档
2 gear

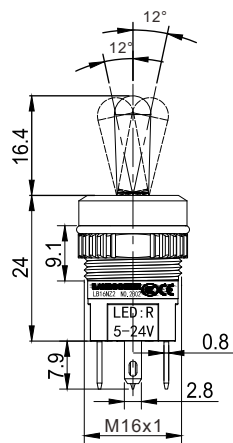

3档
3 gear

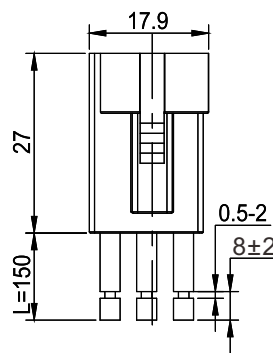
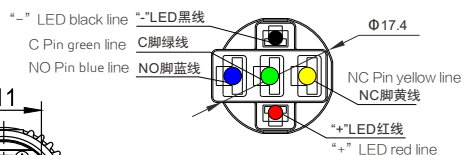
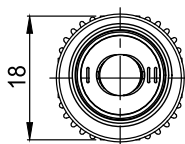
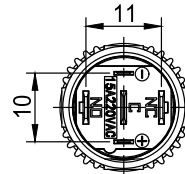
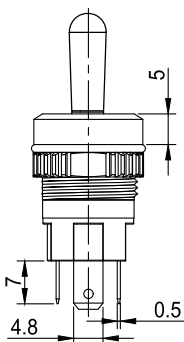

● 灯脚线 ● NC线 ● NO线 ● C脚进线
● 0.5mm², ● 1.5mm²,
线长150mm, 可定做其他规格线长
Wire Length: 150mm, Customize other Sizes

LB19/22X5 Knob 旋钮

新款带灯 1N01NC/2N02NC

Ith:5A 250VAC

IP65

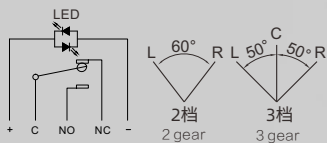

D型限位槽安装
D Locating Slot



低功耗LED: ≤20mA

Low Power Consumption LED: ≤20mA

常规电压: 5-24V 220V, 定制其它电压

Normal Voltage: 5-24V 220V, Customizable Other Voltage

常规颜色: 红色、绿色; 定制: 蓝色、黄色、白色

Normal Color: Red / Green; Customizable: Blue / Yellow / White



大旋柄
手感更好
Big handle



50000H
长寿命灯珠
Long Life LED



25万次
机械寿命
Mechanical Life



镀金/银插脚
Gold Plated/Silver Pins



V2
耐温阻燃
Anti Laming



-40~80°C
耐温性能强
Environment



CCC RoHS REACH CE
专利及认证
Certificate



带灯,大旋柄
LED, Big Handle



专用插件,防误碰设计
Connector



镀金银插脚,银触点
Gold Plated Pins/Silver Contact



头部防水,高亮LED
IP65, With LED

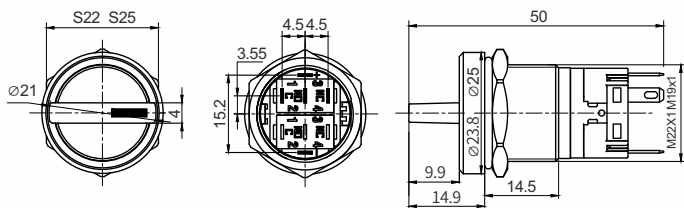

19mm 22mm

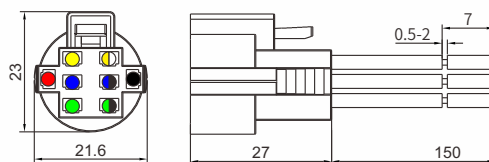

● 灯脚线 ● NC线 ● NO线 ● C脚进线

使用0.5mm²电线, 线长150mm, 可定做其他规格线长
Wire Length: 150mm, 0.5mm², Customize other Sizes

LB19/22Y5 KeySwitch 钥匙钮

新款带灯 1NO1NC/2NO2NC

Ith:5A 250VAC

定制IP65 Customization IP65

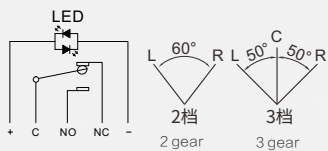

D型限位槽安装
D Locating slot



低功耗LED: ≤20mA

Low Power Consumption LED: ≤20mA

常规电压: 5-24V 220V, 定制其它电压

Normal Voltage: 5-24V 220V, Customizable Other Voltage

常规颜色: 红色、绿色; 定制: 蓝色、黄色、白色

Normal Color: Red/Green; Customizable: Blue/Yellow/White



迷你柄
方便操作
MINI Handle



50000H
长寿命灯珠
Long Life LED



20万次
机械寿命
Mechanical Life



镀金/银插脚
Gold Plated/Silver Pins



V2
阻燃
Anti-falming



-40~80°C
耐温性能强
Environment



CCC RoHS REACH CE
专利及认证
Certificate



皮革纹路手柄, 手感好
Feel Good



可配专用插件
Connector



镀金银插脚, 银触点
Gold Plated Pins/Silver Contact



带灯指示
LED

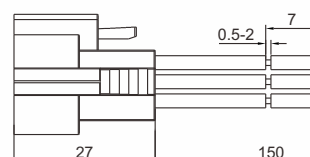
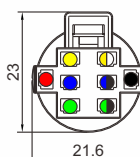
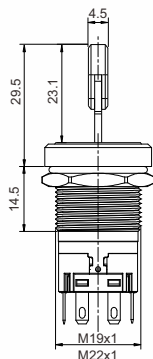
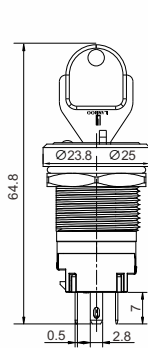
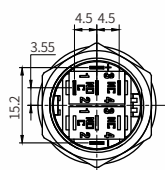
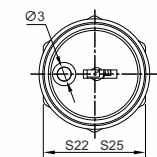

● 灯脚线 ● NC线 ● NO线 ● C脚进线
Lamp base wire NC Line NO Line C Pin Incoming line

使用0.5mm²电线, 线长150mm, 可定做其他规格线长
Wire Length: 150mm、0.5mm². Customizable other Sizes

LBM4/M5.4 Series

防水带灯系列急停按钮

Emergency Stop button with LED

16/19/22mm

Ith:5A 250VAC

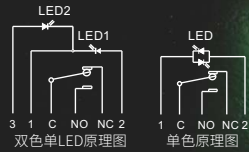

M4可做双色, 比如通电绿色, 按下红色

M4 Power on-Green LED, Push down button-Red LED

M5系列可达IP67, M4可定制IP65

M5 Series IP67, M4 can be customized IP65

低功耗LED: $\leq 20\text{mA}$

Low Power Consumption LED: <math>< 20\text{mA}</math>

常规电压: 5-24V 220V, 定制其它电压

Normal Voltage: 5-24V 220V, Customizable Other Voltage

常规颜色: 红色、绿色; 定制: 蓝色、黄色、白色、M4红绿双色

Normal Color: Red / Green; Customizable: Blue / Yellow / White / M4 Red-Green Bi-color



19M5.4
(IP65)

22M5.4
(IP65)

22M4
(IP65)



RG

M4可做双色
M4 Bi-Color



2500VAC

M5绝缘耐压
High-Insulation



50000H

长寿命灯珠
Long Life LED



25万次

机械寿命
Mechanical Life



V2

耐温阻燃
Anti Laming



-40~80°C

环境耐温强
Environment



IP65/IK10

M5防水防爆
Protection Level



CCC RoHS REACH CE

专利及认证
Certificate



红绿双色指示、防滑边缘
Red-Green Bi-color



D型限位槽设计
"D" Locating Slot



镀金插脚, 银触点
Gold Plated Pins/Silver Contact

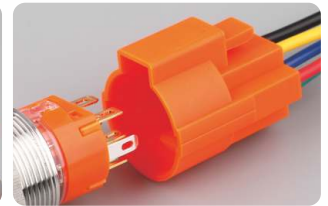

专用接插件
Connector

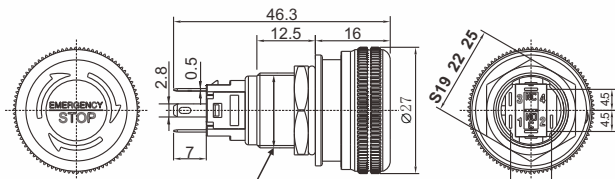

M16x1 M19x1 M22x1

16/19/22M4急停
16/19/22M4 Stop Button

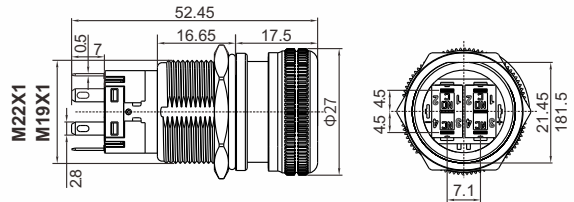

19M5.4 22M5.4急停
19/22M5.4 Stop Button

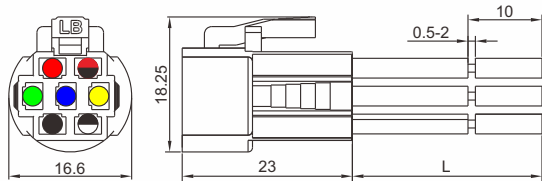

16M4 16A-M11专用接插件
Connector

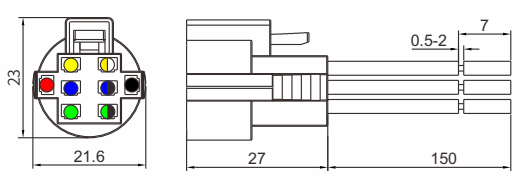

M5.1 M5.2 M5.4专用接插件
Connector

●● 灯脚线 ●● 双色灯脚线 ●● NC线 ●● NO线 ●● C脚进线

使用0.5mm²电线, 线长150mm, 可定做其他规格线长
Wire Length: 150mm 0.5mm², Customize other Sizes

急停系列

STOP Series

16 / 19 / 22mm



LBM6



LBM5.1



LBM5.2



LB16A-M11



LB22M3
8A大电流
High Current



铝氧化加大头部, 手感好
Aluminum Oxide Red



M5.1
M5.4 款

D型限位槽设计
"D" Locating Slot



1NO 1NC 2NO 2NC

镀金插脚, 银触点
Gold Plated Pins/Silver Contact

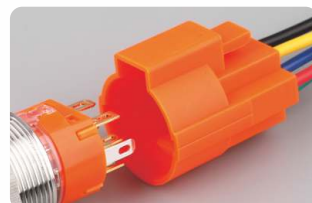

专用接插件
Connector

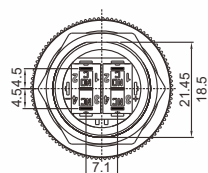

M5.1

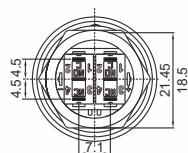

M5.2



M3

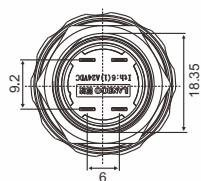

19M6

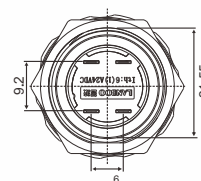

22M6

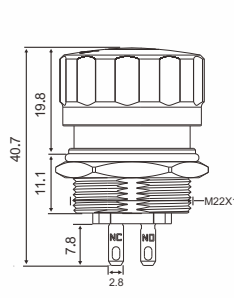
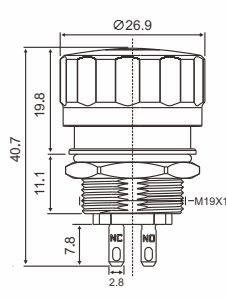
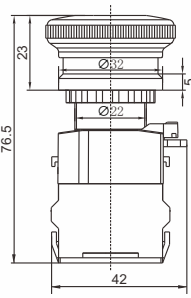
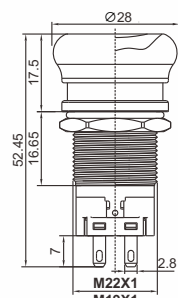
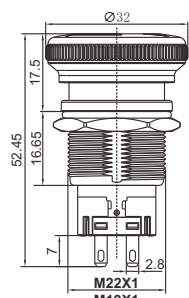

塑料急停系列

SM Series

16mm

IP65

16SM



16SM2

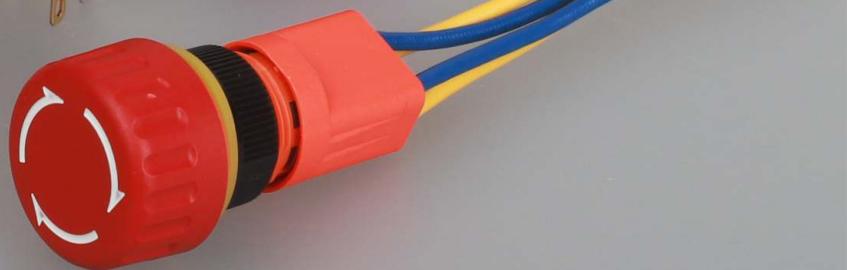

16SM3 (抗UV)
(UV resistance)



防滑头部设计
Head anti slip design



V0级阻燃外壳
V0 flame-retardant shell



镀金插脚, 银触点
Gold Plated Pins/Silver Contact



专用接插件
Connector

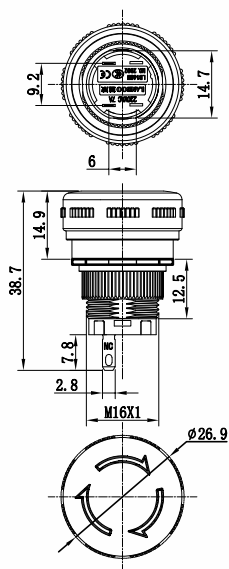

16SM

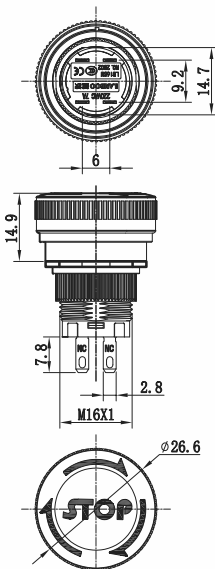

16SM2

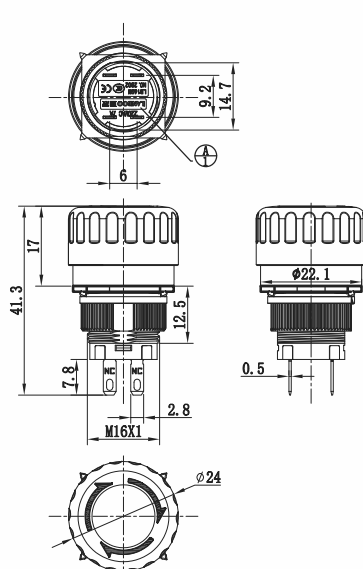

16SM3

高防水带线系列

High waterproof series



高防水带线系列命名规则

Naming convention for high waterproof belt line series

LB Ø ■ - ★ ◆ ◇ / ○ ▲ ▼ / ◎ ● → / ○ / (L) / ※

其它备注: 定制符号、防水要求、特殊颜色要求等

Other remarks: customized symbols, waterproof requirements, special color requirements, etc

(L): 内部代码

(L): Internal code

接头名称: M12-4P (公插), M12-6P (公插), M12-8P (公插), 无-剥线

Connector name: M12-4P (male), M12-6P (male), M12-8P (male), no stripping wire

线长: 150-默认150mm (可定制其它线长)

Line length: 150- default 150mm (other line lengths can be customized)

外壳材质: S-不锈钢, 可定制: N-镀铜铬、A-铝氧化

Shell material: S-stainless steel, customizable: N-copper plated chromium, A-aluminum oxide

LED电压: 5-24V 220V, 定制: 25-48V、110V、AC/DC 通用

LED voltage: 5-24V 220V, customized: 25-48V, 110V, AC/DC universal

发光颜色: R-红色 G-绿色 B-蓝色 定制: Y-黄色 W-白色、三色

Luminous color: R-red G-green B-blue Customization: Y-yellow W-white, three colors

发光形状: E-环形 钥匙与旋钮不写此代码

Luminous shape: E-ring, E+XD - ring+dot, knob and key knob do not write this code

动作形式: F-自复式(点动式) Z-自锁式(保持式)

Action form: F-self resetting (inching) Z-self locking (holding)

开关组合: 10-1NO 20-2NO

Switch combination: 10-1NO 20-2NO

头部形状: P-平头 Y-钥匙钮 X-旋钮

Head shape: P-Flat head, Y-Key, X-Knob

系列号: F-带防水系列 Y1-钥匙钮 X1-旋钮

Serial number: F-With waterproof series, Y1-Key, X1-Knob

安装直径: 16/19/22mm

Installation diameter: 16/19/22mm

蓝波代号

LANBOO Code

LB16F

平头(带防水)金属按钮开关

Metal Button Switch

Ith:7A 250VAC



外壳材质: 304不锈钢、铜镀铬, 可定制铝氧化、不锈钢镀钛
 Material: 304 stainless steel/Copper chrome plating;
 Customizable: Aluminum oxidation/Stainless steel titanium plating
 常规电压: 5-24V 220V, 定制其它电压
 Normal Voltage: 5-24V 220V, Customizable Other Voltage
 常规颜色: 红色、绿色、蓝色; 定制: 黄色、白色
 Normal Color: Red/Green/Blue; Customizable: Yellow/White



Ith:7A
大电流开关
High-Current



1500VAC
高绝缘耐压
High-Insulation



Metal
不锈钢外壳
stainless steel



50000H
长寿命灯珠
Long Life LED



30万次
机械寿命
Mechanical Life



IP68/IK10
防水防爆
Protection Level



-40~80°C
环境耐温强
Environment



CCC RoHS CE REACH
专利及认证
Certificate



不锈钢外壳, 坚固耐用
stainless steel



镀金/银引脚
Silver tin oxide



线性环形发光
stainless steel



防水等级IP67
Waterproof grade IP67

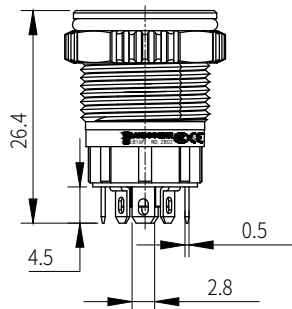
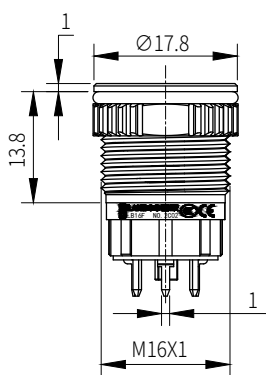

头部防水款
Head waterproofing

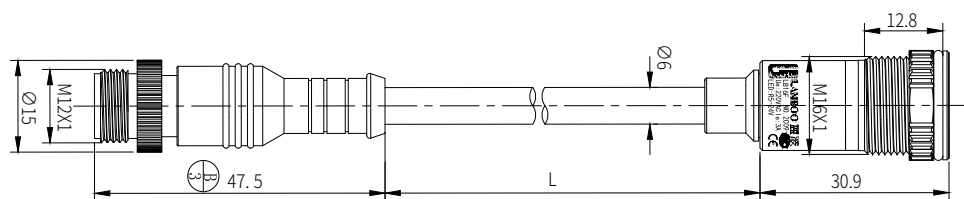
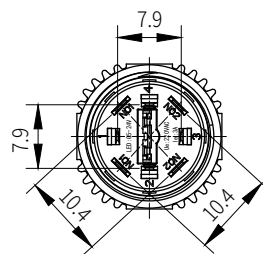
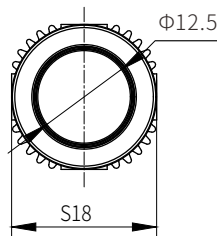

带线全防水款
Fully waterproof with wire

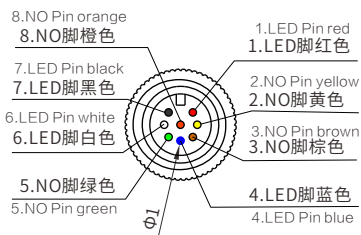

LB16X1 Knob 旋钮

Ith:7A 250VAC

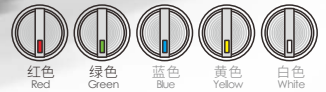

低功耗LED: ≤20mA
 Low Power Consumption LED: ≤20mA
 常规电压: 5-24V 220V, 定制其它电压
 Normal Voltage: 5-24V 220V, Customizable Other Voltage
 常规颜色: 红色、绿色; 定制: 蓝色、黄色、白色
 Normal Color: Red/Green; Customizable: Blue/Yellow/White



大旋柄
手感更好
Big handle



50000H
长寿命灯珠
Long Life LED



二档: 10万次
机械寿命
Mechanical Life



镀金/银插脚
Gold Plated/Silver Pins



V2
耐温阻燃
Anti-laming



-40~80°C
耐温性能强
Environment



CCC RoHS REACH CE
专利及认证
Certificate

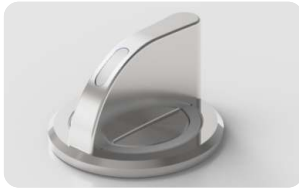

带灯, 大旋柄
LED, Big Handle



镀金/银引脚
Gold Plated Pins/Silver Contact



不锈钢外壳, 坚固耐用
stainless steel



高亮LED 经久耐用
Long Life LED

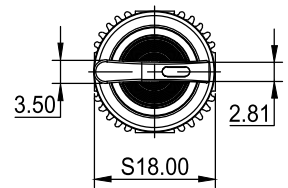
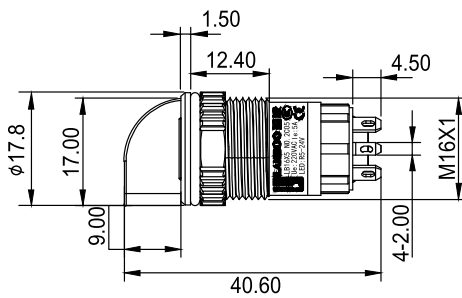
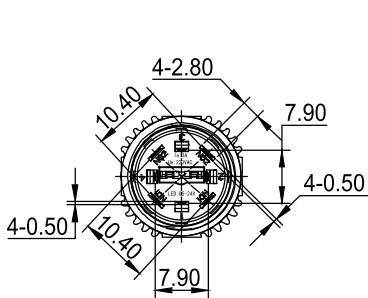

头部防水款
Head waterproofing

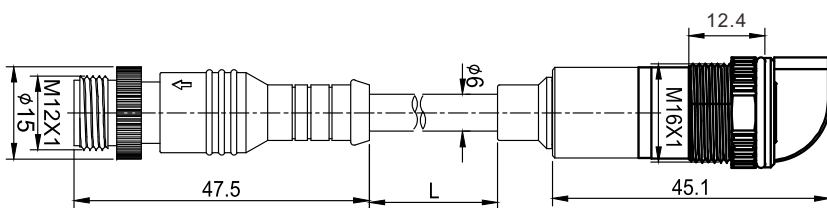

带线全防水款
Fully waterproof with wire

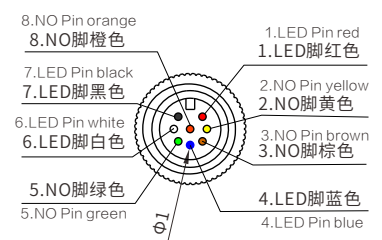

LB16Y1 Key Switch 钥匙钮

1th:5A 250VAC



低功耗LED: ≤20mA
 Low Power Consumption LED: ≤20mA
 常规电压: 5-24V 220V, 定制其它电压
 Normal Voltage: 5-24V 220V, Customizable Other Voltage
 常规颜色: 红色、绿色; 定制: 蓝色、黄色、白色
 Normal Color: Red/Green; Customizable: Blue/Yellow/White



大手柄
方便操作
Big Handle



50000H
长寿命灯珠
Long Life LED



二档: 10万次
机械寿命
Mechanical Life



镀金/银插脚
Gold Plated/Silver Pins



V2
耐温阻燃
Anti-laminating



-40~80°C
耐温性能强
Environment



CCC RoHS REACH CE
专利及认证
Certificate



大手柄方便操作
Big Handle



不锈钢外壳
Stainless steel



镀金/银引脚
Silver tin oxide



环形指示灯
LED

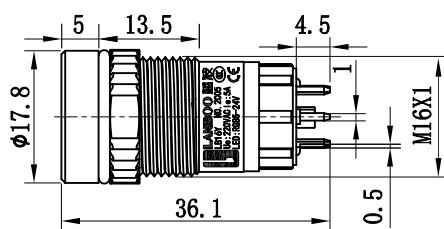
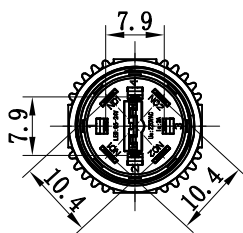

头部防水款
Head waterproofing

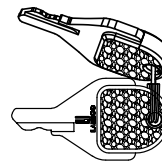
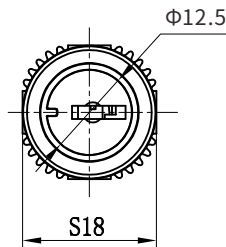

配套钥匙
Key

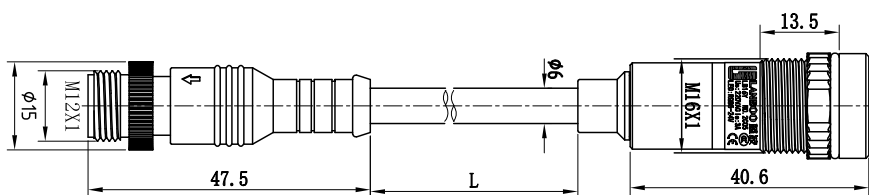

带线全防水款
Fully waterproof with wire

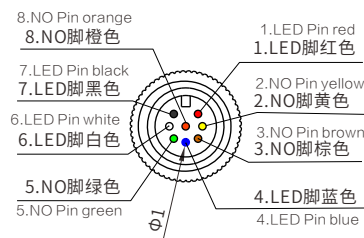

LB19X1 Knob 旋钮

Ith:7A 250VAC

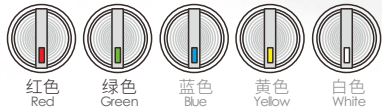

低功耗LED: $\leq 20\text{mA}$
 Low Power Consumption LED: $\leq 20\text{mA}$
 常规电压: 5-24V 220V, 定制其它电压
 Normal Voltage: 5-24V 220V, Customizable Other Voltage
 常规颜色: 红色、绿色; 定制: 蓝色、黄色、白色
 Normal Color: Red/Green; Customizable: Blue/Yellow/White



大旋柄
手感更好
Big handle



50000H
长寿命灯珠
Long Life LED



二档: 10万次
机械寿命
Mechanical Life



镀金/银插脚
Gold Plated/Silver Pins



V2
耐高温阻燃
Antif Laming



-40~80°C
耐温性能强
Environment



CCC RoHS REACH CE
专利及认证
Certificate



带灯, 大旋柄
LED, Big Handle



镀金/银引脚
Gold Plated Pins/Silver Contact



不锈钢外壳, 坚固耐用
stainless steel



高亮LED 经久耐用
Long Life LED

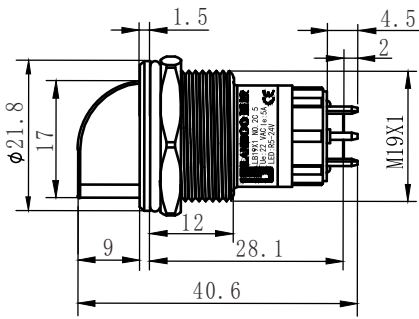
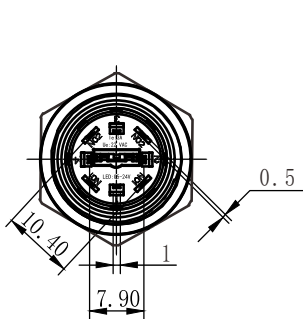

头部防水款
Head waterproofing

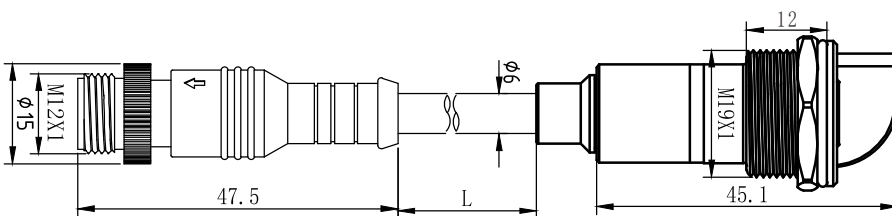
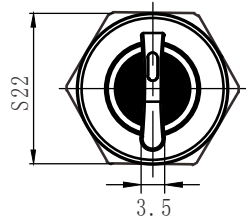

带线全防水款
Fully waterproof with wire

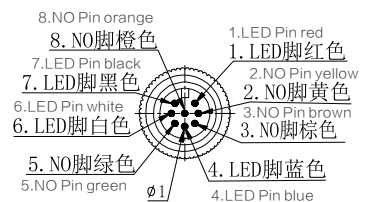

LB19Y1

Key Switch
钥匙钮

Ith:5A 250VAC



低功耗LED: ≤20mA
Low Power Consumption LED: ≤20mA
常规电压: 5-24V 220V, 定制其它电压
Normal Voltage: 5-24V 220V, Customizable Other Voltage
常规颜色: 红色、绿色; 定制: 蓝色、黄色、白色
Normal Color: Red/ Green; Customizable: Blue/ Yellow/ White



大手柄
方便操作
Big Handle



50000H
长寿命灯珠
Long Life LED



二档: 10万次
机械寿命
Mechanical Life



镀金/银引脚
Gold Plated/Silver Pins



V2
耐温阻燃
Anti-f Laming



-40~80°C
耐温性能强
Environment



CCC RoHS REACH CE
专利及认证
Certificate

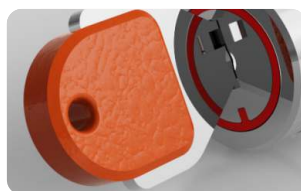

大手柄 方便操作
Big Handle



不锈钢外壳
Stainless steel



镀金/银引脚
Silver tin oxide

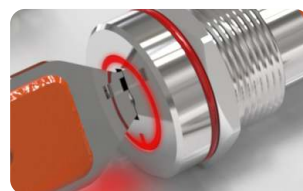

环形指示灯
LED

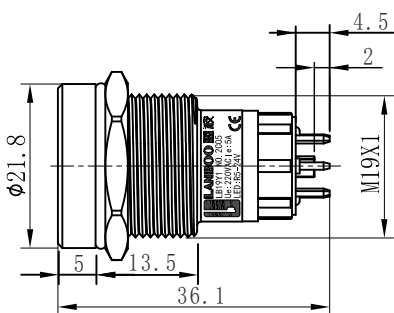
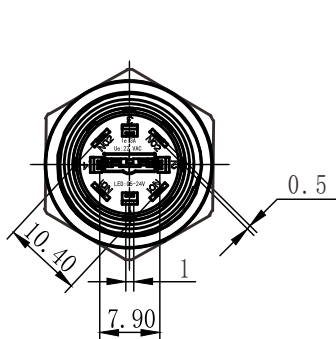

头部防水款
Head waterproofing

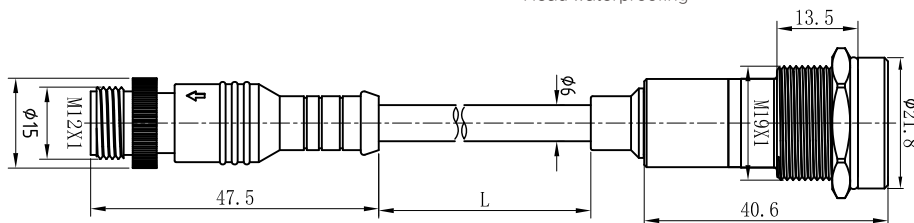
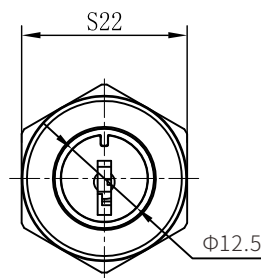

带线全防水款
Fully waterproof with wire

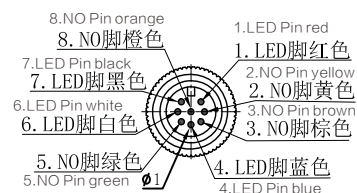

LB22F 平头 (带防水) 金属按钮开关 Metal Button Switch

Ith:10A 250VAC



外壳材质: 不锈钢, 可定制铝氧化、铜镀铬
Material: stainless steel;
Customizable: Aluminum oxidation/Copper chrome plating
常规电压: 5-24V 220V, 定制其它电压
Normal Voltage: 5-24V 220V, Customizable Other Voltage
常规颜色: 红色、绿色、蓝色; 定制: 黄色、白色
Normal Color: Red/Green/Blue; Customizable: Yellow/White



Ith:10A
大电流开关
High-Current



2500VAC
高绝缘耐压
High-Insulation



Metal
不锈钢外壳
stainless steel



50000H
长寿命灯珠
Long Life LED



30万次
机械寿命
Mechanical Life



IP68/IK10
防水防爆
Protection Level



-40~80°C
环境耐温强
Environment



CCC RoHS CE REACH
专利及认证
Certificate



不锈钢外壳, 坚固耐用
stainless steel



高亮LED, 经久耐用
Long Life LED



不锈钢按键
stainless steel



防水等级IP68
Waterproof grade IP68

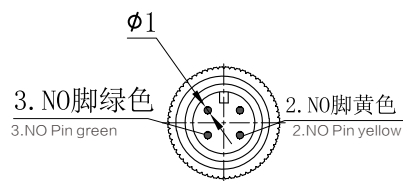
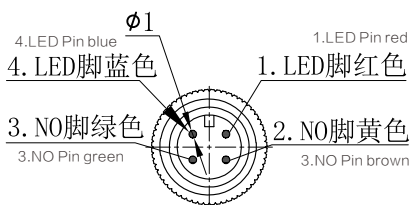
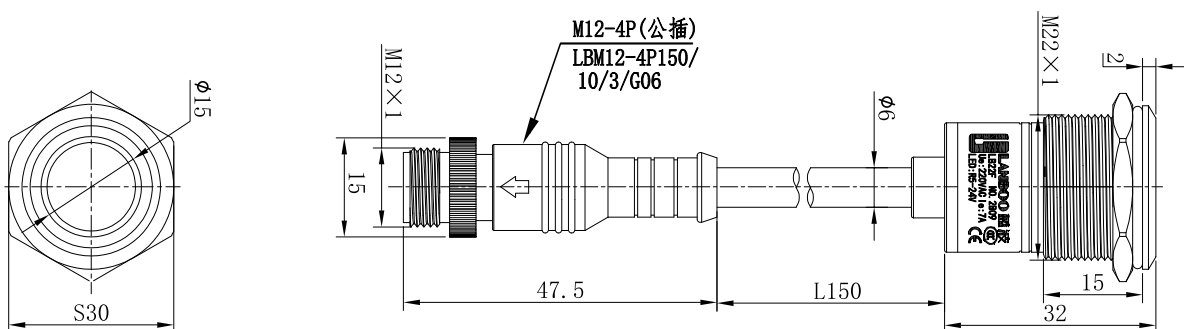

LB6-25Z 信号灯

Indicator Light

IP68



6-12mm: IP40/其中10/12mm可做双色9-24V 220V
 6-12mm: IP40, 10/12mm Bi-color/9-24V 220V
 16-25mm: IP68/螺丝脚款可做双色三色/5-24V 220V
 16-25mm: IP68/Screw pins Bi-color, Tri-color/5-24V 220V

- RGB**
可做双色三色
Bi-Color Tri-Color
- 灯光高亮 大发光面**
Whole Facelight
- 50000H**
长寿命灯珠
Long Life LED
- <20mA**
低功耗
Low-Power
- V0**
耐温阻燃
Anti-laming
- 40~80°C**
环境耐温强
Environment
- IP68/IK10**
防水防爆
Protection Level
- CCC RoHS REACH CE**
专利及认证
Certificate



6-12mm 亚光面发光
Matte Surface



16-25mm 亮面大发光面
Bright Glowing



16-25mm 螺丝脚款可做双色三色
Screw Pins/Bi-Color/Tri-Color



五颜六色, 灯光明亮
Multicoloured

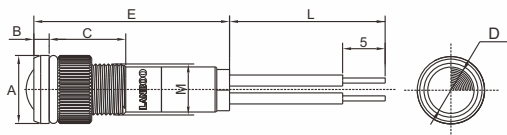

6~12mm 0.15mm²铜芯线
Copper core wire

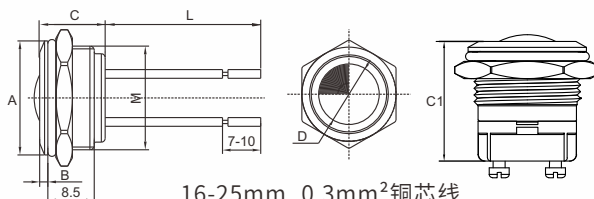

16-25mm 0.3mm²铜芯线
Copper core wire

直径 Diameter	A	B	C	D	E	L
6mm	Ø8	1.8	9	Ø5.5	23	150
8mm	Ø10	1.8	10	Ø5.5	23.6	150
10mm	Ø12	1.8	11	Ø8	23.6	150
12mm	Ø14	1.8	11	Ø8	23.6	150

直径 Diameter	A	B	C	C1	D	L
16mm	Ø17.8	1.5	12	18	Ø11.5	150
19mm	Ø20.9	1.5	12	18	Ø11.5	150
22mm	Ø24.8	2	13	18	Ø18	150
25mm	Ø27.9	2	13	18	Ø18	150

LB8/10A 高亮信号灯

Highlight Indicator Light

IP68



低功耗LED: ≤20mA
Low Power Consumption LED

常规电压: 5-24V 220V, 定制其它电压
Normal Voltage: 5-24V 220V, Customizable Other Voltage



- 灯光高亮 大发光面
Whole Face Light
- 72°C 透镜聚光
Optical lens Spotlight
- LED 50000H 长寿命灯珠
Long Life LED
- <20mA 低功耗
Low power Consumption
- V2 耐温阻燃
Anti Laming
- 40~80°C 环境耐温强
Environment
- IP68/IK10 防水防爆
Protection Level
- CCC RoHS REACH CE 专利及认证
Certificate



小巧精致
Delicate



专用插插件
Connector



透镜聚光好
Optical lens Spotlight



五颜六色, 灯光明亮
Multicoloured

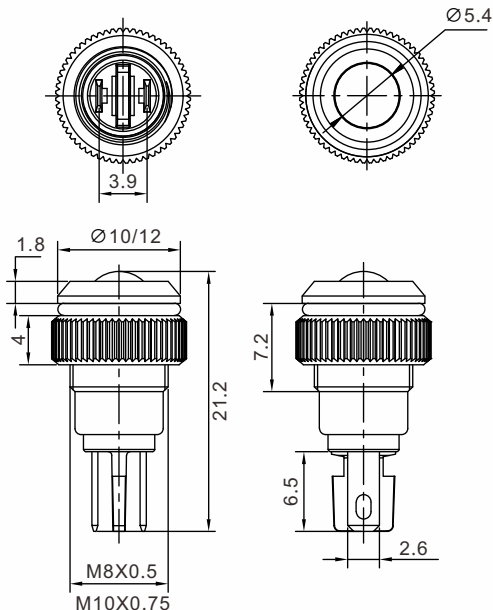

金属指示灯命名规则

Naming convention for metal indicator lights

- LB \diamond \star \odot \blacktriangle \blacktriangledown \oplus \bullet \ast
- 其它备注: 定制符号、防水要求、特殊颜色要求等
Other remarks: customized symbols, waterproof requirements, special color requirements, etc.
 - 螺丝脚: J-螺丝脚 Screw foot: J-screw foot
 - 线长-150mm (标注150mm, 可定做其它尺寸), (不带线的指示灯忽略此项)
Line length - 150mm (marked with 150mm, other sizes can be customized), (ignored for indicator lights without lines)
 - 外壳材质: S-不锈钢 N-黄铜镀铬 A-铝氧化
Shell material: S-stainless steel N-brass chrome plating A-aluminum oxidation
 - 带灯电压: 6-12Z-9-24V/220V; 16Z-25Z-8A: 5-24V/220V, 其它电压定制
Voltage with lamp: 6-12Z-9-24V/220V; 16Z-25Z-8A: 5-24V/220V, customized for other voltages
 - 发光颜色: $\color{red}\square$ -红 $\color{green}\square$ -绿 $\color{blue}\square$ -蓝 $\color{yellow}\square$ -黄 W-白 $\color{red}\square\color{green}\square$ -双色 $\color{red}\square\color{green}\square\color{blue}\square$ -三色
Glow color: $\color{red}\square$ -red $\color{green}\square$ -green $\color{blue}\square$ -blue $\color{yellow}\square$ -yellow W-white $\color{red}\square\color{green}\square$ -two-tone $\color{red}\square\color{green}\square\color{blue}\square$ -tricolor
 - 发光类型: C-整面发光 D-点灯(暂无)
Luminous type: C-full face luminous D-lighting (currently unavailable)
 - 头部形状: P-平头 Q-球头
Head shape: P-flat head Q-ball head
 - 系列号: Z-高端款 A-高亮款 (8A, ϕ 8mm) D-老款
Series Number: Z-High end A-High highlight (8A, only ϕ 8mm) D-old model
 - 开孔尺寸(Dimension): ϕ 6, ϕ 8, ϕ 10, ϕ 12, ϕ 16, ϕ 19, ϕ 22, ϕ 25mm
 - 蓝波代码
LANBOO Code

例: 直径12mm, 球头整面黄色发光, 12V, 铜镀铬材质 对应型号: LB12Z-Q/CY9-24V/N/150(L)

Example: 12mm diameter, ball head emitting yellow light on the entire surface, 12V, copper chrome plated material
Corresponding model: LB12Z-Q/CY9-24V/N/150(L)

LBFMQ 蜂鸣器

ACOUSTO-OPTIC BUZZER SERIES

金属头部/阻燃外壳

Metal head/Retardant shell

70~100DB/5cm

DC12V/24V/AC220V

IP65



70-100DB/5cm
蜂鸣响亮
Sonority



约0.5S
间隙闪烁
Clearance Flashing



10000H
持续通电1万小时
Continuous Electricity



IP65/IK10
防水防尘
Protection Level



V2
耐温阻燃
Anti-flaming



-40~80°C
耐温性能强
Environment



CCC RoHS REACH CE
专利及认证
Certificate



304金属面罩、IP65
304StainlessSteel、IP65



球头发光角度更大
Ball head



螺丝脚方便接线
Screw Pins



高亮闪烁灯光
70dB/LED

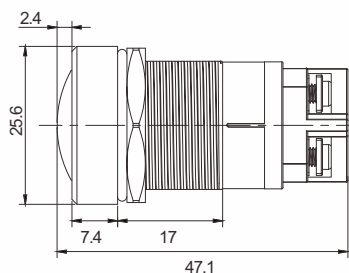
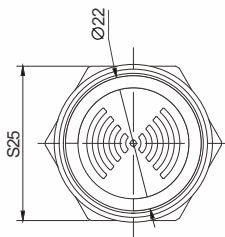
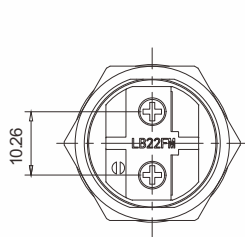

2系列经济款

2Series economical models

12B2 16A2 19A1.2 22B2 25B2

12B2金属按钮开关



16A2金属按钮开关 Metal Button Switch



19A1.2金属按钮开关 Metal Button Switch



22B2 25B2金属按钮开关 Metal Button Switch



LB16SA Series

新品-塑料按钮开关

Flame Retardant Plastic Switch

高亮面材质 Bright surface

1NO1NC



整面发光
Bright Surface



红色 Red 绿色 Green 蓝色 Blue 黄色 Yellow 白色 White

低功耗LED: $\leq 20\text{mA}$

Low Power Consumption LED: $\leq 20\text{mA}$

常规电压: 9-24V 220V, 定制其它电压

Normal Voltage: 9-24V 220V, Customizable Other Voltage

常规颜色: 红色、绿色、蓝色; 定制: 黄色、白色

Normal Color: Red/Green/Blue; Customizable: Yellow/White

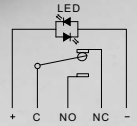

12.4mm
大发光面
Whole Face LED



5000VAC
高绝缘耐压
High-Insulation



50000H
长寿命灯珠
Long Life LED



20万次
机械寿命
Mechanical Life



V0
耐温阻燃
Antiflaming



-40~80°C
环境耐温强
Environment



IP65
防尘防溅水
Protection Level



CCC RoHS REACH CE TUV CE(TUV) CB(TUV)
专利及认证
Certificate



发光面积大, 灯光柔和
Whole Face LED



专用接插件, 镀银插脚
Connector Silver Plated Pins



按键凹面设计, 防滑螺母
Non-Slipnuts

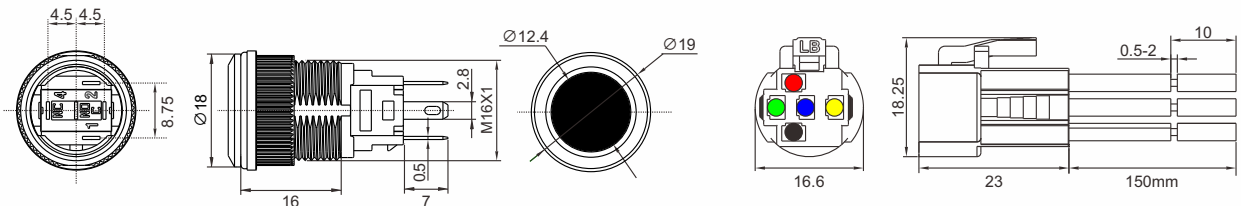

● ● LED灯脚

● Nc常闭脚 ● No常开脚 ● C公共进线脚

0.5mm²电线, 长150mm, 可定做其他规格线长
Wire Length: 150mm 0.5mm², Customize other Sizes

LB22SA1

高端快插式按钮开关、指示灯
Push Button、Indicator Light

彻底改变传统接线

Completely change the traditional wiring

Fast Connection



1S
秒插接线



25A
Ui:660V
Ith:25A



22mm
开孔直径



50000H
长寿命LED



≥50万次电气寿命
≥1000万次机械寿命

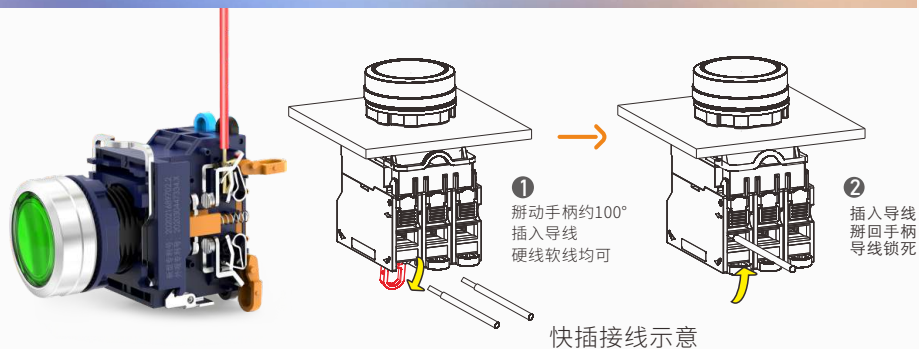

IP65 IK08

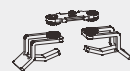

→ Ith:25A

慢动双银点
Silver Contact



→ 3500VAC

工频耐压
Rated impulse
withstand voltage



→ 10000000

次机械寿命
Mechanical life



→ 1 S

秒插接线
Second patch cord



→ 80N

正向拉力
电线无脱落
Wire locking strength

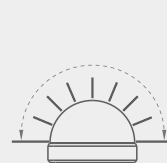

180°
水平无盲区

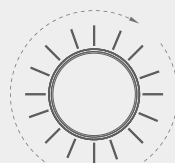

360°
发光指示

360°发光

大球面高亮发光
安全再次升级

Large sphere highlighting
Security upgrade again



LB22SA1

高端快插式按钮开关、指示灯

Plastic Push Button、Indicator Light

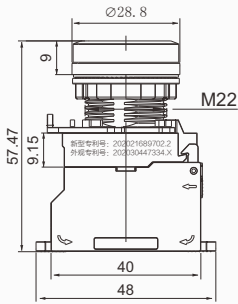

无灯复位款

No light reset model

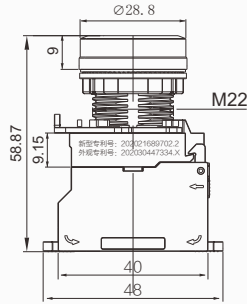

带灯自锁/自复
无灯自锁款

Self locking/self resetting with lights
Unlighted self-locking model

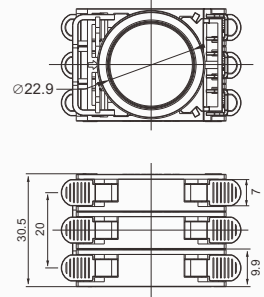
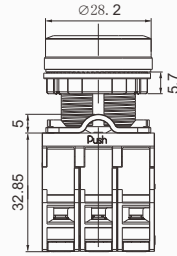

所有触点模块尺寸相同

All contact modules have the same size

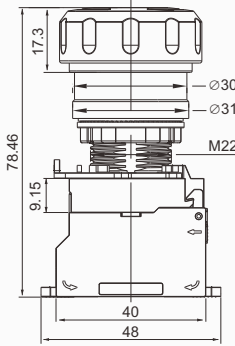

M1急停(塑料红色头部)

M1 emergency stop (plastic red head)

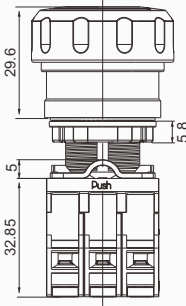

M3急停(铝氧化红色头部)

M3 emergency stop (aluminum oxide red head)

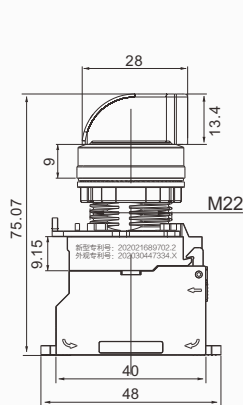
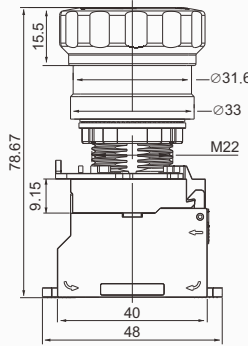

旋钮
knob

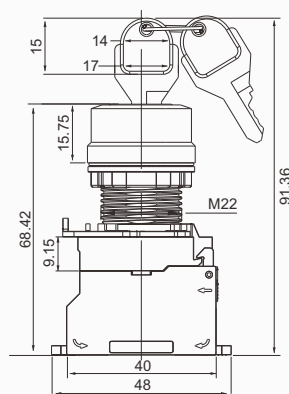
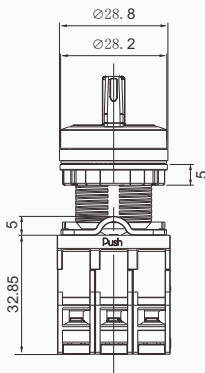

钥匙钮
key

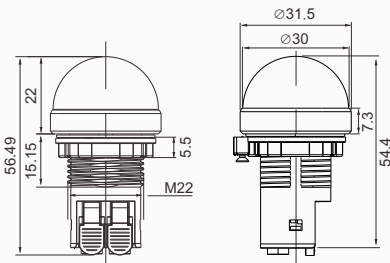
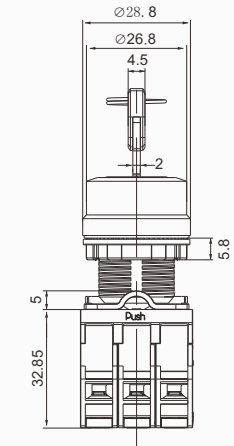

球头指示灯
Ball head indicator light

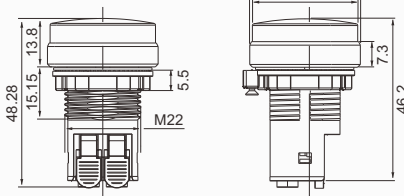

平头指示灯
Flat head indicator light

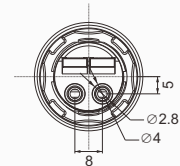

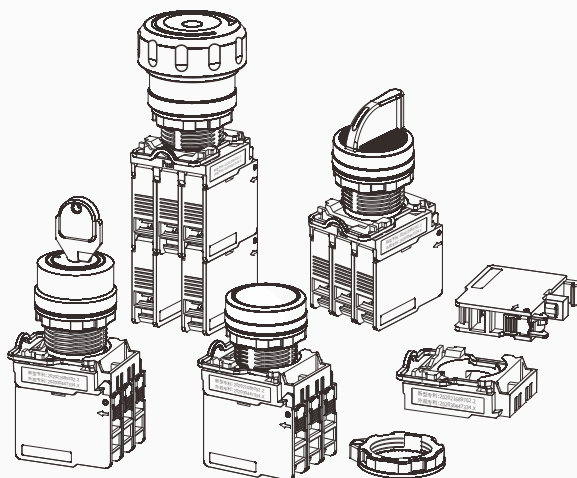

- 
3NO3NC...
 多触点组合
- 
25A
 $U_i: 660V$
 $I_{th}: 25A$
- 
22mm
 开孔直径
- 
LED
50000H
 长寿命LED
- 
 ≥ 50 万次电气寿命
 ≥ 1000 万次机械寿命

LB22SA2

多触点组合式按钮开关、指示灯
 Multi contact combination button switch and indicator light





IP65
IK08

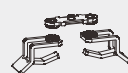
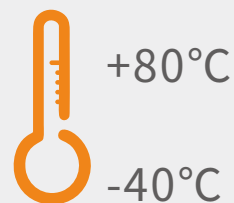

→ Ith:25A

慢动双银点
Silver Contact



→ ≤ 4.5mm

急停安装最
大面板厚度
Emergency stop
Installation



→ 3500VAC

工频耐压
Rated impulse
Withstand voltage



→ 10000000

次机械寿命
Mechanical life



→ ≥ 200N

头部与中座
间防脱落顶力
Head and middle



→ > 50000h

五万小时寿命
无极灯珠
Electrodeless Lamp
Beads

← 金属头
自锁
Metal head
Self-locking



凹面设计, 贴合手指
手感更舒适
comfortable feel



↑
1NC
慢动
双触点

1NC slow acting
double contact

↑
灯座
220V
红色发光

Lamp holder 220V
red emitting



PA66



铝氧化色
Aluminum oxide color



铜镀铬(定制)
Copper chrome plating
(customized)



不锈钢(定制)
Stainless steel
(customized)



镀钛(定制)
Titanium plating
(customized)



可定制黑色
旋柄+铝氧化
本色头部

Customizable black
handle+aluminum oxide
natural color head



可定制黑色
旋柄+铝氧化
黑色头部

Customizable black
handle+aluminum oxide
black head



可定制氧化
黑色头部

Customizable oxidized
black head

上图型号示例

LB22SA2-P1CZ/R220V/A

LB22SA2

高端快插式按钮开关、指示灯

Plastic Push Button、Indicator Light



LB22SA2-P ◆■/PC

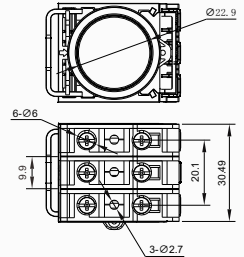
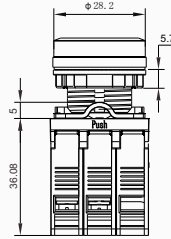
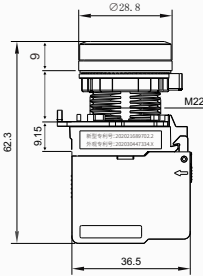

LB22SA2X1-X ◆■/A (银色)
(silvery)

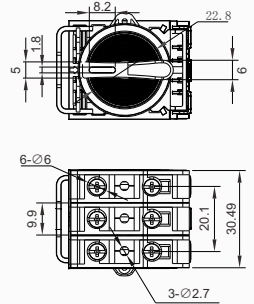
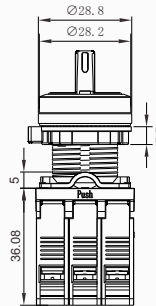
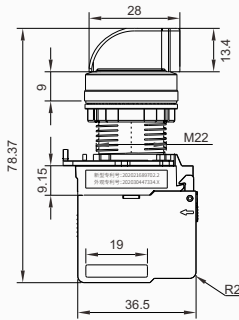

LB22SA2Y1-Y ◆■/A

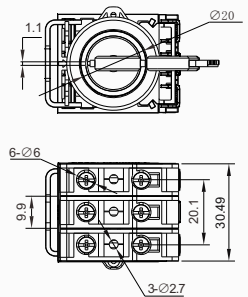
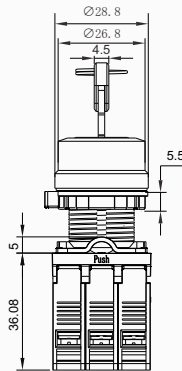
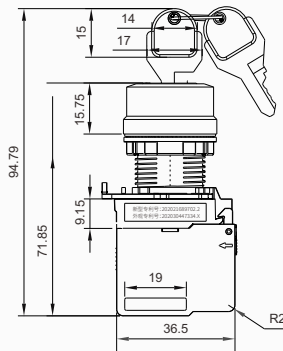

M1 emergency stop (plastic head)
M1急停(塑料头部)
LB22SA2M1-M ◆■/PC

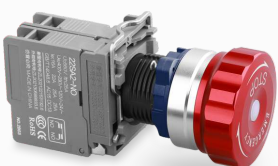
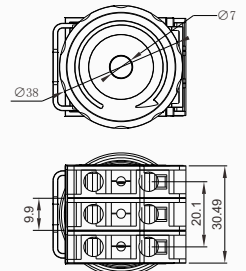
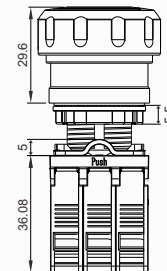
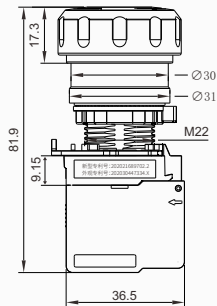

M3 emergency stop (Aluminum oxide head)
M3急停(铝氧化头部)
LB22SA2M3-M ◆■/A

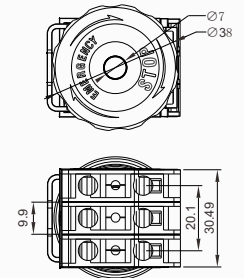
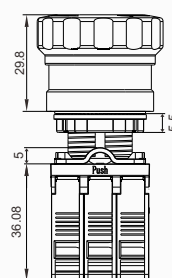
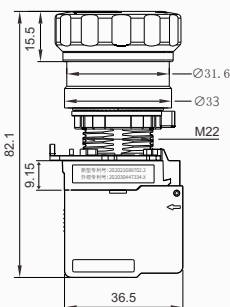

LBS1 Series

锌合金槽型光电开关

Zinc Alloy Sensor Switch

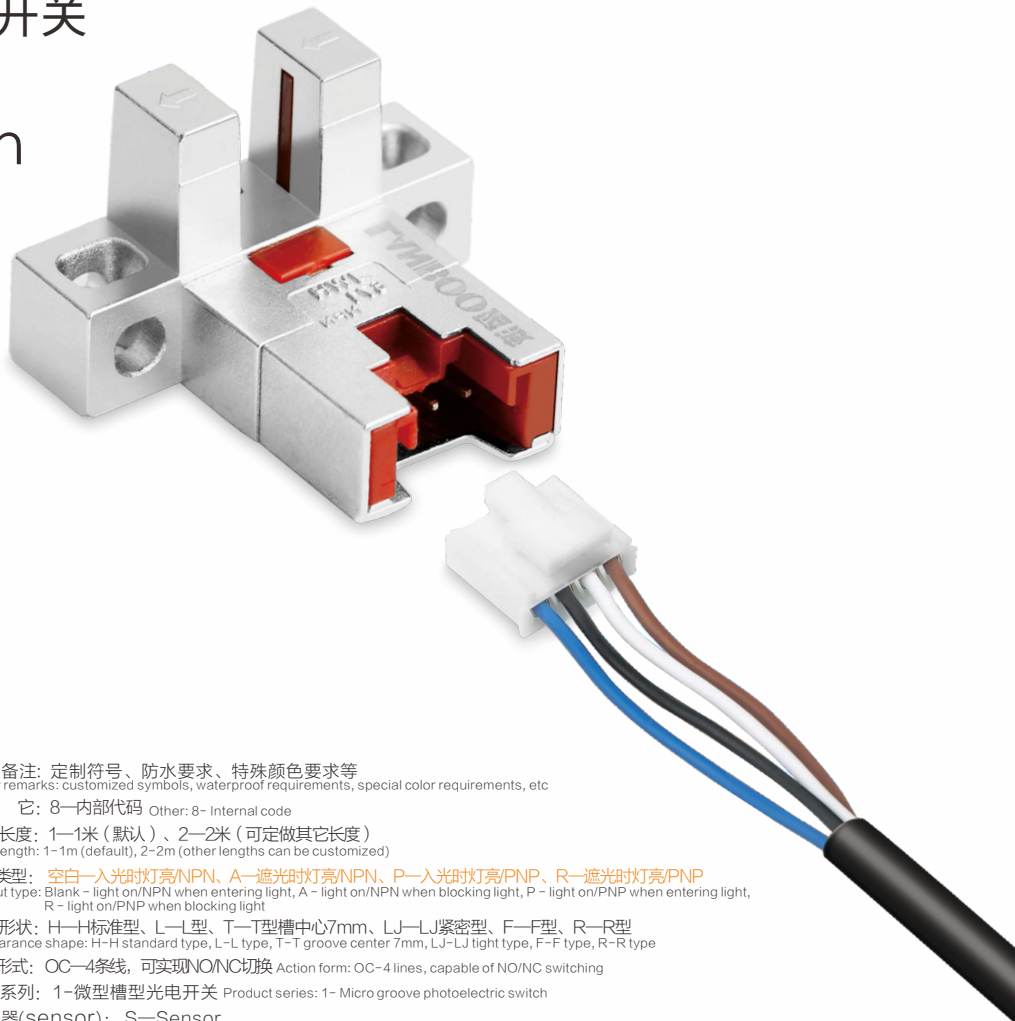

光电开关命名规则

Naming convention for photoelectric switches

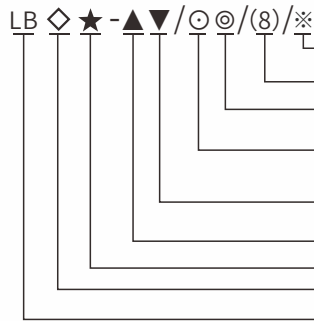

其它备注: 定制符号、防水要求、特殊颜色要求等
Other remarks: customized symbols, waterproof requirements, special color requirements, etc

其它: 8-内部代码 Other: 8- Internal code

导线长度: 1-1米(默认)、2-2米(可定做其它长度)
Wire length: 1-1m (default), 2-2m (other lengths can be customized)

输出类型: 空白-入光时灯亮/NPN, A-遮光时灯亮/NPN, P-入光时灯亮/PNP, R-遮光时灯亮/PNP
Output type: Blank - light on/NPN when entering light, A - light on/NPN when blocking light, P - light on/PNP when entering light, R - light on/PNP when blocking light

外观形状: H-H标准型, L-L型, T-T型槽中心7mm, LJ-LJ紧凑型, F-F型, R-R型
Appearance shape: H-H standard type, L-L type, T-T groove center 7mm, LJ-LJ tight type, F-F type, R-R type

动作形式: OC-4线, 可实现NO/NC切换 Action form: OC-4 lines, capable of NO/NC switching

产品系列: 1-微型槽型光电开关 Product series: 1- Micro groove photoelectric switch

传感器(sensor): S-Sensor

蓝波代号 LANBOO Code

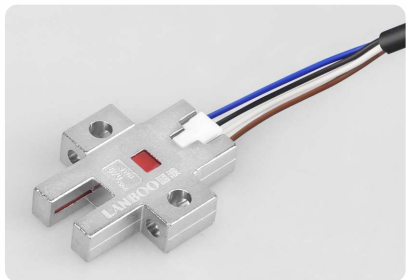

LBS1-OCH/1/8(E-SX670)

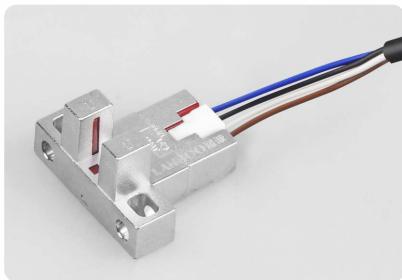

LBS1-OCL/1/8(E-SX671)

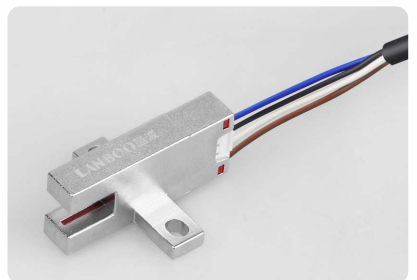

LBS1-OCT/1/8(E-SX672)

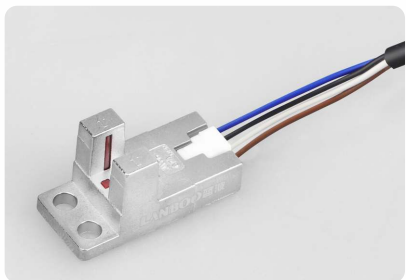

LBS1-OCLJ/1/8(E-SX674)



LBS1-OCF/1/8(E-SX676)

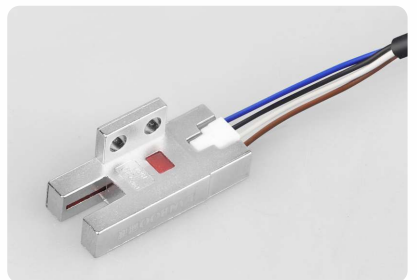

LBS1-OCR/1/8(E-SX677)



Zinc
锌合金外壳
Zinc Alloy Shell



100m/S²
抗震抗压
Anti-Vibration



EWI
屏蔽干扰
Shield



90%
维护成本降90%
Easy Maintenance



3000Hz
响应精度高
High Precision



5-24VDC
宽电压
Wide Voltage



NO/NC
常开常闭
Open/Close



镀金插脚
Gold Plated pins



-25~55°C
环境耐温强
Environment



RoHS REACH
专利及认证
Certificate

定制开发系列

Custom Development Series

优秀的研发团队, 可根据您的需求量身定制各种开关
Excellent R&D team, can be customized according to your needs of various switches

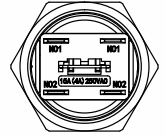
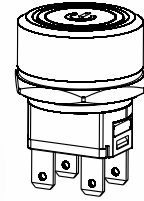
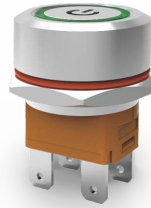
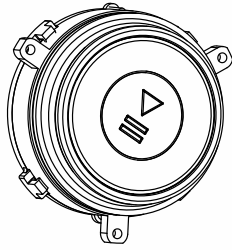

某机器人公司定制
Customized by Robot Company

格力电器定制
Custom made by Gree Electric



定制符号及外壳系列

CUSTOMIZABLE ARBITRARY SYMBOL



LB ϕ FW-J1-1.1

Emergency Stop Protective Cover

急停防误保护罩

ϕ 16mm ϕ 19mm ϕ 22mm



Quality Material
好材质



Safe Care
安全防护



Easy Installation
使用方便



Quality Guarantee
高品质

材质:ABS

外壳工艺:亚光黄色/灰色磨砂喷漆

适用孔径:16mm 19mm 22mm

Shell process:Matte yellow/gray frosted paint

Apply the aperture:16mm,19mm,22mm

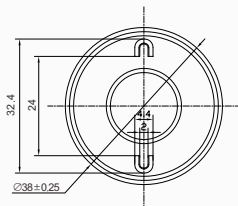

LB16FW-J1-1.1

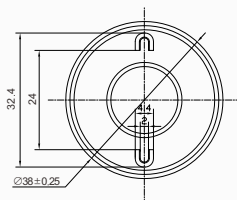

LB19FW-J1-1.1

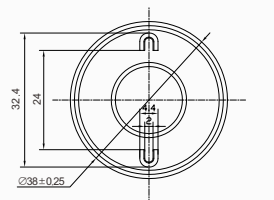

LB22FW-J1-1.1

LBFW Anti Misoperation Cover 防误操作盖

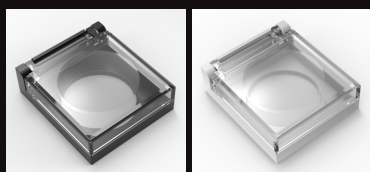

黑色款/Black 银色喷漆款/Silver

12mm / LB12FW-A1

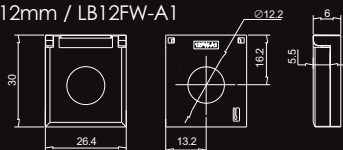

16mm / LB16FW-A1

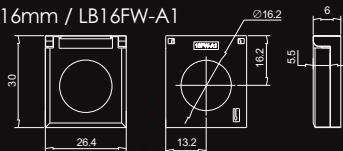

19mm / LB19FW-A1

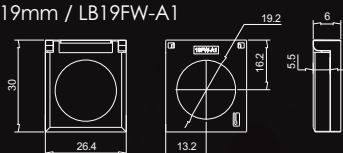

22mm / LB22FW-A1

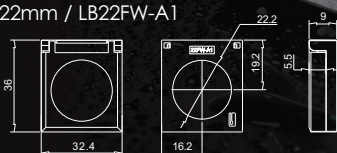

25mm / LB25FW-A1

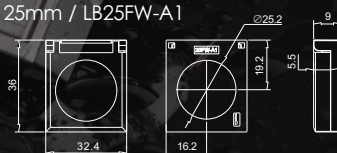

LBØFW-1



LBØFW-2



LBØFSG



防水罩/16mm 19mm 22mm
Waterproof

硅胶材质, 耐用耐腐蚀
Silicone Waterproof

LBBS Nutwrench 螺母扳手

12mm 16mm 19mm 22mm



22mm

19mm

16mm

12mm



穿绳孔设计, 避免遗失
Avoid Missing



防滑设计, 出汗都不怕
Antiskid



加厚边缘, 不爆边
Thicken Edge



出线口设计, 焊线了也不怕
Outlet

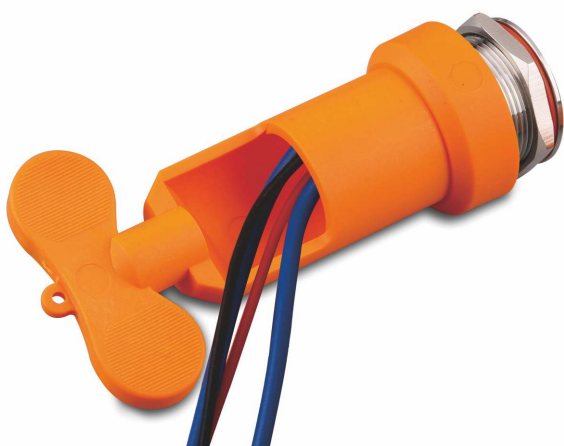

还这样拧? 不仅费劲还伤手
Difficulty, Hurts hand

强烈推荐
Recommend



老板! 还是这样好用哦
Boss! I want this

● 中国·蓝波智能科技有限公司

LANBOO INTELLIGENT TECHNOLOGY CO.,LTD

📍 中国·浙江省乐清市城东街道永兴二路12号
No.12,Yongxin 2 Road,Chengdong Street,YueQing City,ZheJiang province,China

☎ 0577-62385330 (温州总公司)

☎ 0577-62385332

🌐 lanbodg.tmall.com

📞 销售:13165850065 (微信)

售后:15372868655 (微信)

🌐 nan-bo.com

lanboo.vip

随着时间不断推移,技术不断的更新,若有更改恕不另行通知,产品图片若与实物有差别,请以实物为准,本公司保留最终解释权!未经允许请勿转载翻印,版权归蓝波所有.