





DATA SHEET

LuminOx O₂ Sensors Luminescence-based Optical Series

FEATURES

- Luminescence-based optical technology, NOT electrochemical
- Contains no hazardous materials; RoHS & REACH compliant
- Connects directly to a microcontroller without any additional circuitry
- Factory calibrated
- High accuracy
- Maintenance free^a



Housing  COMPACT	Supply Voltage  4.5 - 5.5 V VOLTAGE	Operating Temp  +10°C to +45°C TEMPERATURE	Output Digital  TTL	Response Time  < 30 secs
---	---	--	---	---

BENEFITS

- Low cost
- Low power, long life due to non-depleting sensing principle
- Compact footprint

OUTPUT VALUES^b

Oxygen range (LOX-02)	0—25% O ₂
Oxygen pressure range	0—300mbar ppO ₂
Response time	T90 < 30s (typical)
Accuracy	
ppO ₂	< 2% FS
Temperature	Indication only
Pressure (LOX-02)	±5mbar
O ₂ (LOX-02)	Determined by ppO ₂ & pressure accuracy
Resolution	
ppO ₂	0.1mbar
Temperature	0.1°C
Pressure (LOX-02)	1mbar
O ₂ (LOX-02)	0.01%

TECHNICAL SPECIFICATIONS

Supply voltage (Vs)	5V _{DC} (4.5V _{DC} min. —5.5V _{DC} max.)
Supply current (Is)	<7.5mA (streaming one sample per second), <20mA Peak
Output Type	3.3V TTL level UART (5V tolerant)
Temperature	
Operating:	+10°C to +45°C
Storage:	-30°C to +60°C
Humidity	0—99% Rh (non-condensing)
Barometric pressure range	
LOX-01	100—1400mbar
LOX-02	500—1200mbar

Other sensor options available on request, email:
technical@sstsensing.com

Need help? Ask the expert
Tel: + 44 (0)1236 459 020
and ask for “Technical”



NOTES

- The sensor housing can be cleaned using a damp cloth. Do NOT immerse the sensor in any cleaning media.
- At ambient conditions. All performance measurements are at STP unless otherwise stated. Following extreme temperature fluctuations, re-calibration may be required.

OUTLINE DRAWING



All dimensions shown in mm. Tolerances = ±0.5mm.

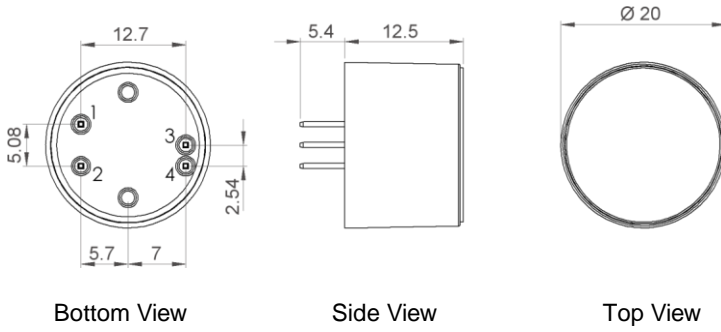

ELECTRICAL INTERFACE

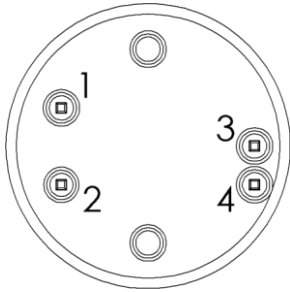

Pin	Designation
1	Vs (+5V)
2	GND (0V)
3	3.3V UART* Sensor Transmit
4	3.3V UART* Sensor Receive

* 5V tolerant.

Connection: Four gold-plated pins (0.64mm²) on a 2.54mm grid for PCB mounting via sockets or hand soldering using no-clean flux.

Note: If hand soldering, recommended iron temperature is 370°C for < 3s per pin.

Note: Do NOT put the sensor through a PCB washing process.

Note: Always apply power to sensor pins 1 and 2 before attempting to communicate on pins 3 and 4.

The sensor should be treated as an electronic component and handled using the correct ESD handling precautions.



SENSOR CONSTRUCTION

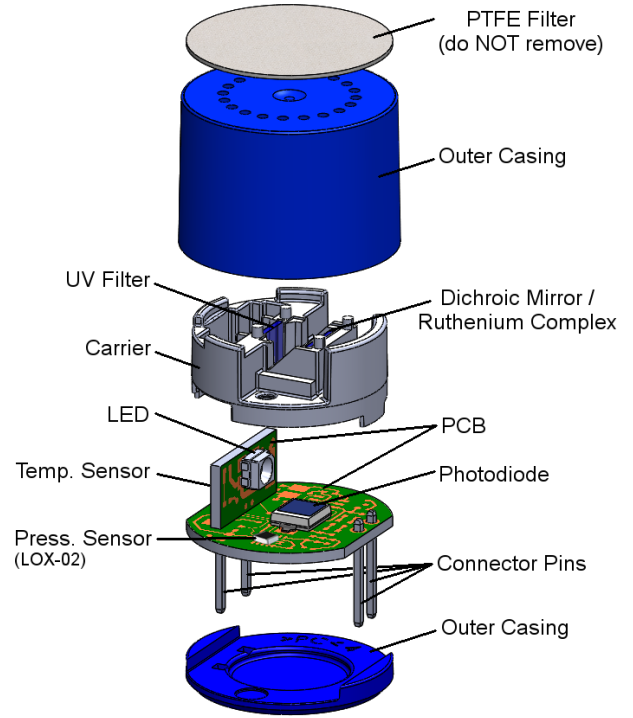

ORDER INFORMATION

Generate your specific part number using the convention shown below. Use only the numbers that correspond to the sensor option you require — omit those you do not.

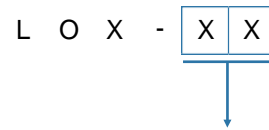

Type
01 Measures 0—300mbar ppO ₂ and temperature (°C)
02 Measures 0—300mbar ppO ₂ , 0—25% O ₂ , temperature (°C) and 500—1200mbar barometric pressure

CAUTION

Do not exceed maximum ratings and ensure sensor(s) are operated in accordance with their requirements. Carefully follow all wiring instructions. Incorrect wiring can cause permanent damage to the device. Do NOT use chemical cleaning agents.

Failure to comply with these instructions may result in product damage.

These products must not be used in safety applications where product failure could cause injury or risk to life

INFORMATION

As customer applications are outside of SST Sensing Ltd.'s control, the information provided is given without legal responsibility. Customers should test under their own conditions to ensure that the equipment is suitable for their intended application.

For technical assistance or advice, please email:
technical@sstsensing.com

General Note: SST Sensing Ltd. reserves the right to make changes to product specifications without notice or liability. All information is subject to SST Sensing Ltd.'s own data and considered accurate at time of going to print.

