

CLE-24 SERIES

Constant Current LED Driver

DANUBE

FEATURES

- EFFICIENCY UP TO 96%
- CONSTANT CURRENT LED DRIVER
- WIDE INPUT AND OUTPUT VOLTAGE RANGE
- INPUT VOLTAGE UP TO 36V
- PWM/DC DIMMING CONTROL
- SHORT CIRCUIT PROTECTED
- INTERNAL SMD TECHNOLOGY
- FULLY ISOLATED PLASTIC CASE WITH IP67 LEVEL
- UL 94V-0 PACKAGE MATERIAL
- RoHS COMPLIANT
- 3 YEARS WARRANTY

IP67

CE

FC

REACH
COMPLIANT

RoHS
COMPLIANT



DESCRIPTION

CLE-24 series is a high efficiency, constant current and step-down DC/DC converter. The LED DRIVER operates from an input voltage 6Vdc to 36Vdc and provides an externally adjustable output current of up to 1500mA and output power up to 45 watts. It is able to include the function of Over current protection(OCP), PWM/Digital Dimming and ON/OFF.

The device can extensively be used for Landscape illumination, Special illumination, Back light source, Commercial illumination, Street light illumination, Home use illumination and Automobile illumination etc.

SELECTION GUIDE

MODEL NUMBER	INPUT NOMINAL VOLTAGE (VDC)	INPUT VOLTAGE RANGE (VDC)	OUTPUT VOLTAGE RANGE (VDC)	OUTPUT CURRENT RANGE (mA)	DIMMING/DC CONTROL	EFF (% ,Max.)
CLE-24-1.00D(W)(S)	24	6-36	2-30	0-1000	PWM/DC	96
CLE-24-1.20D(W)(S)	24	6-36	2-30	0-1200	PWM/DC	96
CLE-24-1.50D(W)(S)	24	6-36	2-30	0-1500	PWM/DC	96

● PARTNUMBES STRUCTURE

Series	Coding Scheme	
CLE-24 Series	CLE-x1-x.x2y1zzz	<p>CLE = Series Name</p> <p>x1 = Input Voltage</p> <p>x.x2 = Output Current</p> <p>y1=Package Style(D=PINS)(W=WIRED)(S=SMD)</p> <p>Zzz = 0~9 , A~Z or blank for market purpose.</p>

● SPECIFICATIONS

(Typical at 25°C, nominal input voltage, rated output current unless otherwise specified)

Project	Working Condition	Min.	Typ.	Max.	Unit
Input Voltage(absolute maximum)				36	VDC
Recommended Input Voltage		6	24	36	VDC
Input Filter		Capacitor			
Output Voltage range	Vin=36V	2		30	VDC
Output Current Accuracy	Vin=24V,5LEDS		±5	±6	%
Output Current Stability	Vin=24V,1LED to 5LEDS		±5	±6	%
Maximum Capacitive Load				2.2	uF
Operating Frequency				1000	KHz
Ripple & Noise (20MHz BW)				1500	mVp-p
Short Circuit Protection		Continuous			
Temperature Coefficient	-40°C~+71°C ambient			±0.03	%°C
Operating Temperature	1000mA/1200mA/1500mA	-40		71	°C
Storage Temperature		-55		125	°C
Humidity (D) (W)				95	%
Humidity (S)				85	%
Maximum Case Temperature				100	°C
MTBF (using MIL-HDBK 217F)	Operating Temperature 25°C	2000000			Hours
Case Material		Non Conductive plastic			
Potting Material		Epoxy (UL94V-0)			
Case Size (D) (W)		31.8*20.3*12.2			mm
Case Size (S)		31.8*20.3*10.9			mm
Weight (D)			15.6		g
Weight (W)			18		g
Weight (S)			12.8		g
EMI Radiated Emissions		EN55015			
Dust Test & Waterproof Test (D)(W)		IP67			

● **PWM DIMMING AND ON/OFF CONTROL** (Leave open if not use)

Project	Working Condition	Min.	Typ.	Max.	Unit
ON/OFF Control	ON (DIM ~ -VIN)	2.6		5.5	VDC
	OFF (DIM ~ -VIN)	0		0.4	VDC
Quiescent Input Current in Shutdown Mode	Vin=24			1	mA
PWM Frequency	For Linear Operation	100		500	Hz
	(measured 1%~100% Dimming)				

● **ANALOGUE DIMMING CONTROL** (Leave open if not use)

Project	Working Condition	Min.	Typ.	Max.	Unit
Input Voltage Range		0		5.5	VDC
Control Voltage Range Limits	ON (DIM ~ -VIN)	0.5		2.5	VDC
	OFF (DIM ~ -VIN)	0		0.4	VDC
Quiescent Input Current in Shutdown Mode	Vin=24			1	mA

● **PWM DIMMING AND ON/OFF CONTROL** (measured 1~100% Dimming)

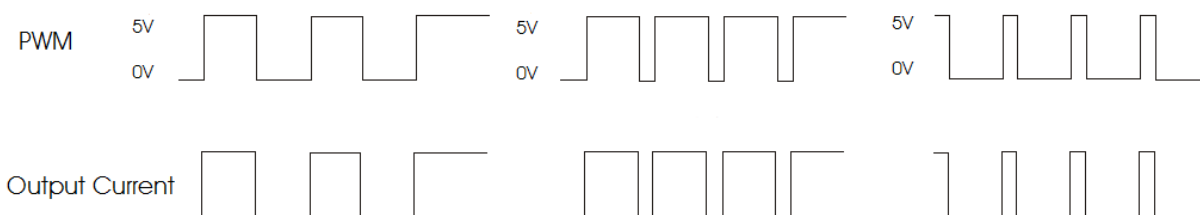

● **ANALOGUE DIMMING CONTROL** (measured 20%~100% Dimming)

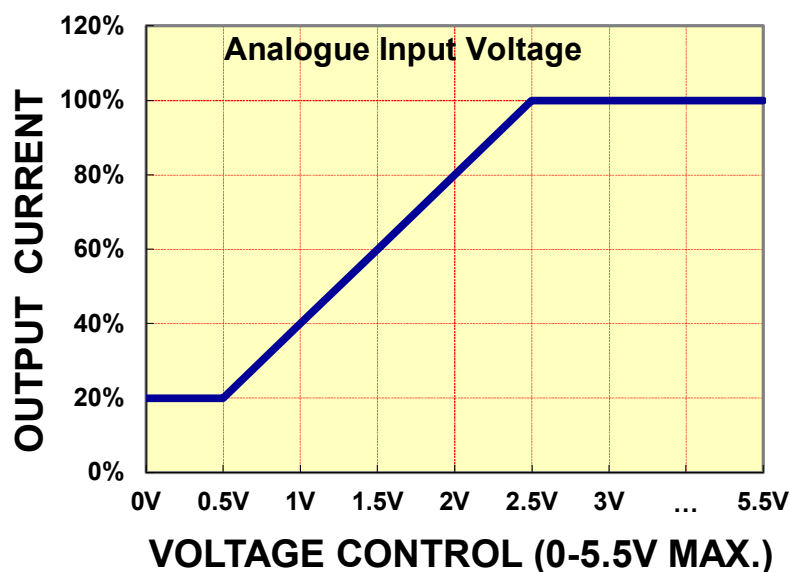

● TYPICAL APPLICATIONS

PWM Dimming control circuit

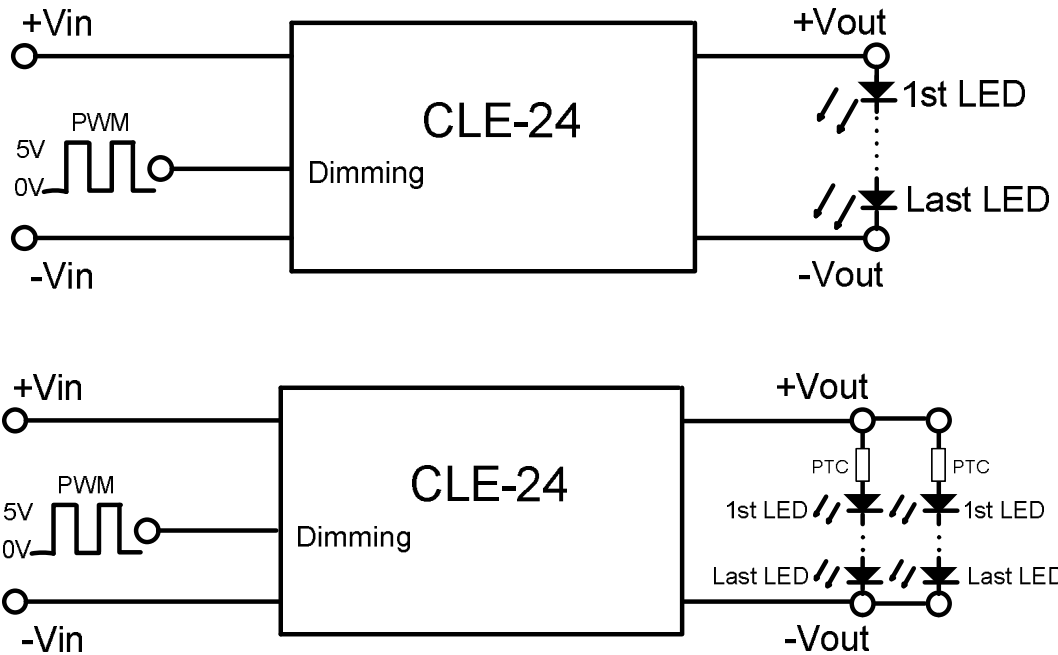
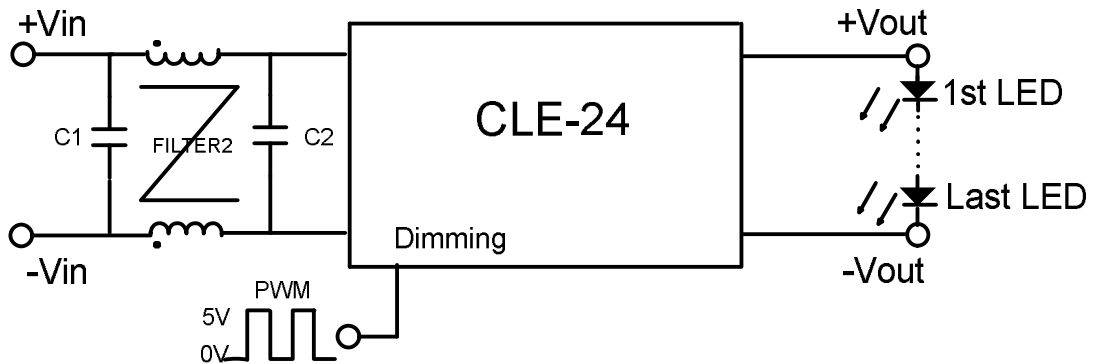

Fig.2

In actual use, if necessary to protect LED, a PTC of positive temperature coefficient may be connect to the input end of every channel or all channels, as shown in Fig.2.

EMI filter circuit



● **TYPICAL APPLICATIONS**

Analogue Dimming control circuit

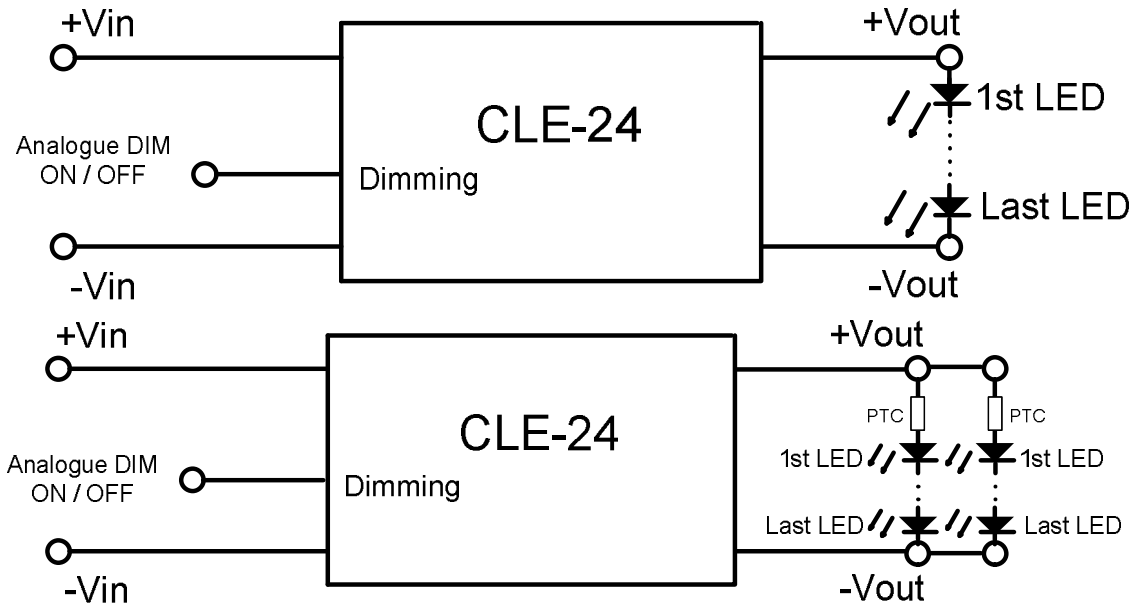

● **EFFICIENCY VS. LOAD LED** $T_A=25^\circ\text{C}$

1-LED $V_F=3.6\text{V}$; 2-LED $V_F=7.2\text{V}$; 3-LED $V_F=10.8\text{V}$; 4-LED $V_F=14.4\text{V}$; 5-LED $V_F=18\text{V}$;

OUTPUT CURRENT 1.0A

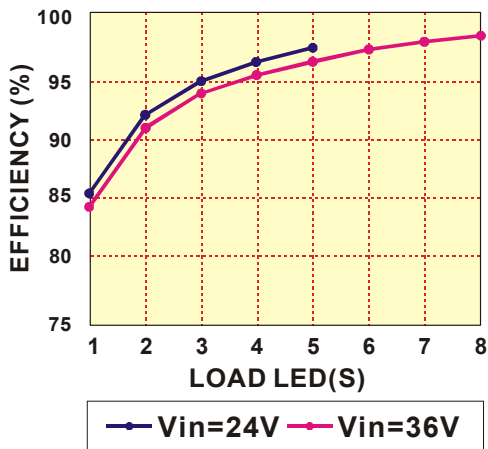

OUTPUT CURRENT 1.20A

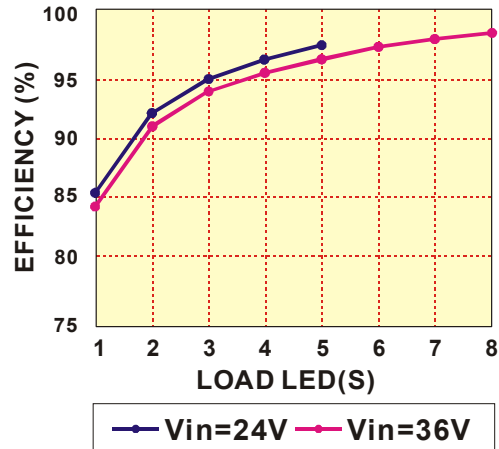

OUTPUT CURRENT 1.50A

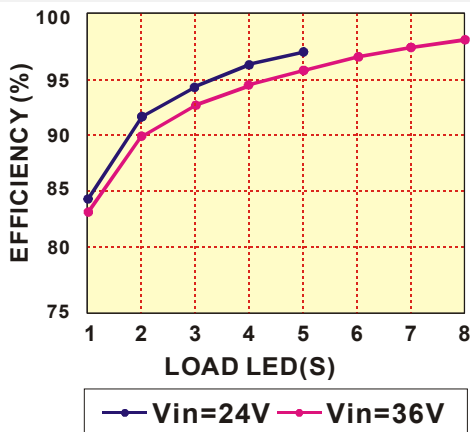

● DERATING CURVE

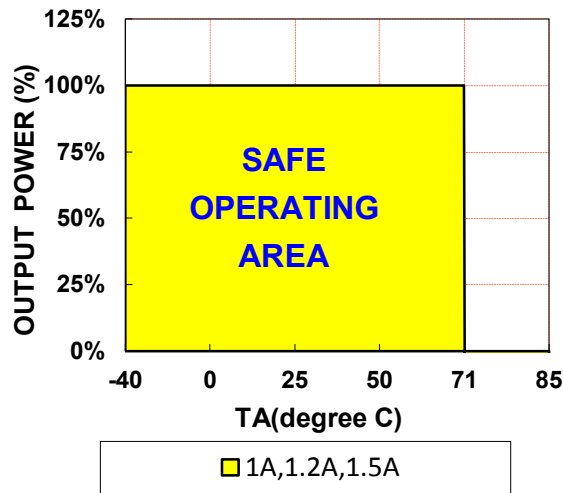

● MECHANICAL DIMENSIONS RECOMMENDED FOOTPRINT DETAILS

PACKAGE "D"

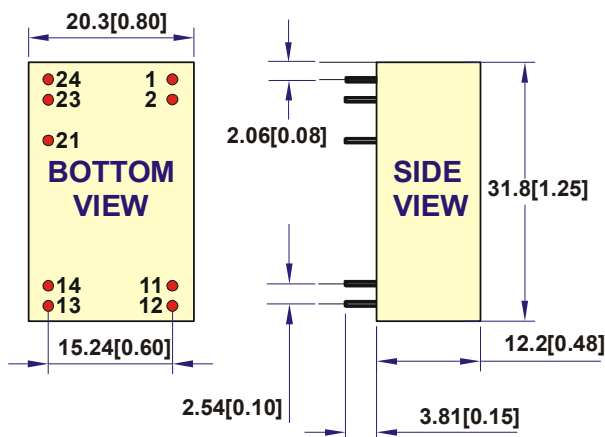

PINOUT		COMMENT
1 & 2	-Vin	Don't connect to -Vout
11 & 12	-Vout	LED - Connection
13 & 14	+Vout	LED + Connection
21	PWM/DC DIM	ON/OFF/PWM/DC Dimming Leave open if not used
23 & 24	+Vin	DC Supply

All dimensions are in mm[inches]

NOTE:

Pin Size is Tolerance $0.60\Phi \pm 0.05\text{mm}$

All dimensions are in mm [inches]

Tolerance .X or .XX= $\pm 0.5\text{mm}$

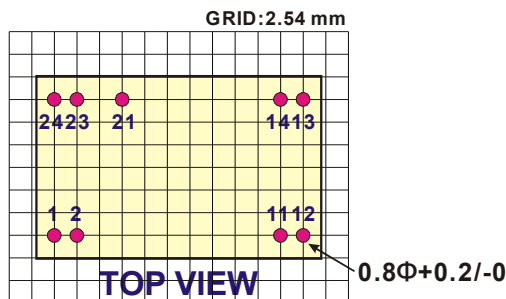

PACKAGE "W"

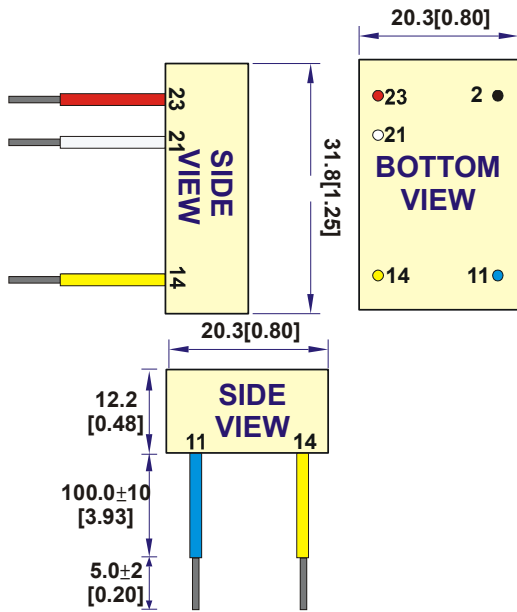

All dimensions are in mm[inches]

PINOUT		COMMENT
2 (Black)	-Vin	Don't connect to -Vout
11 (Blue)	-Vout	LED - Connection
14 (Yellow)	+Vout	LED + Connection
21 (White)	PWM/DC DIM	ON/OFF/PWM/DC Dimming Leave open if not used
23 (Red)	+Vin	DC Supply

NOTE:

All dimensions are in mm [inches]

1. Case Tolerance .x or .xx ±0.5mm

2. Wire outside diameter=1.6mm ±0.1

3. Wire core diameter =0.75mm ±0.1

4. Wire is UL 3385/CAS TEM listed #22AWG/300V/105°C Rated

PACKAGE "S"

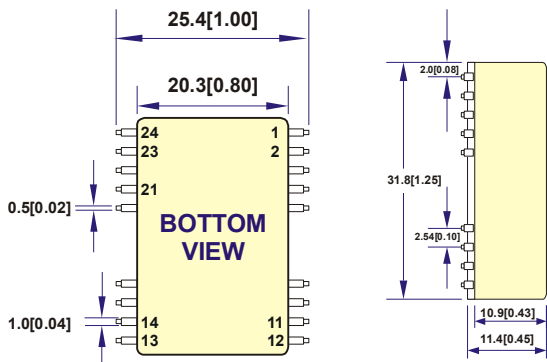

All dimensions are in mm[inches]

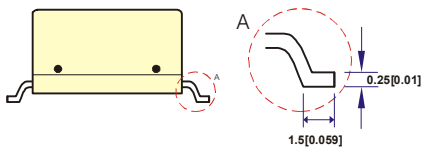

PINOUT		COMMENT
1 & 2	-Vin	Don't connect to -Vout
11 & 12	-Vout	LED - Connection
13 & 14	+Vout	LED + Connection
21	PWM/DC DIM	ON/OFF/PWM/DC Dimming Leave open if not used
23 & 24	+Vin	DC Supply

NOTE:

All dimensions are in mm [inches]

Tolerance .X or .XX= ±0.5mm

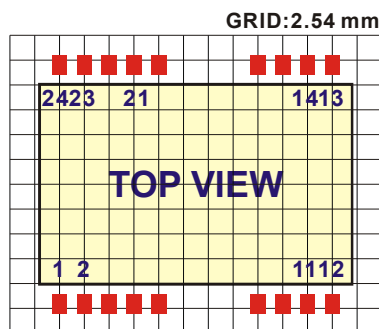

● REFLOW SOLDERING CURVE

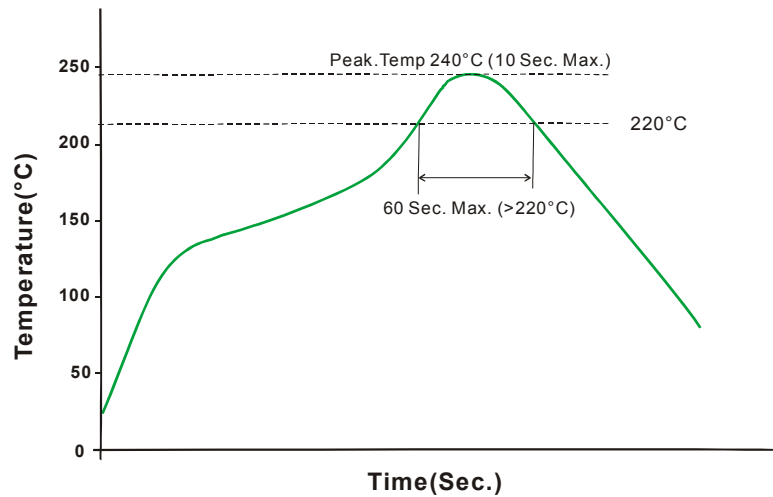

Remark:The curve applies only to the hot air reflow soldering.

FOR MORE INFORMATION CALL:

Danube Enterprise Co., Ltd.

Tel: 886-7-3755165

Fax: 886-7-3755330

E-mail: danube@ms10.hinet.net

Home Page

<http://www.danube.com.tw>
