

Features:

- Universal AC input / Full range
- No load power consumption < 0.075W
- Compact size
- Comply with EN55022 Class B without any additional components
- Protections: Short circuit / Overload / Over voltage
- Cooling by free air convection
- Isolation Class II
- High reliability, low cost
- 3 years warranty



Applications:

- Industrial electrical equipment
- Mechanical equipment
- Factory automation equipment
- Handheld electronic device



Description

IRM-02 is a 2W miniature (33.7*22.2*15mm) AC-DC module-type power supply, ready to be soldered onto the PCB boards of various kinds of electronic instruments or industrial automation equipments. This product allows a universal input voltage range of 85~305VAC. The phenolic case and the fully-potted silicone enhance the heat dissipation and meet the anti-vibration demand up to 5G; moreover, it provides the fundamental resistance to dust and moisture. With the high efficiency up to 77% and the extremely low no-load power consumption below 0.075W, IRM-02 series fulfills the worldwide regulation for the low power consumption requirement for electronics. The entire series is a Class II design (no FG pin), incorporating the built-in EMI filtering components, enabling the compliance with EN55022 Class B; the supreme EMC features keep the end electronic units from electromagnetic interference. In addition to module-type model, IRM-02 series also offers the SMD style model.

Model Encoding

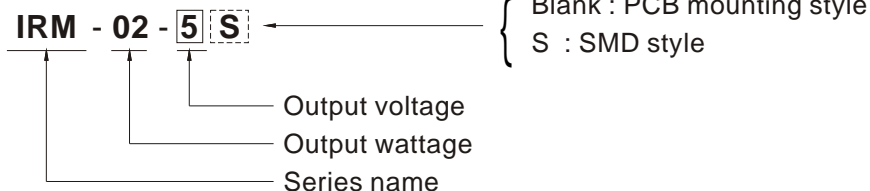

SPECIFICATION

MODEL		IRM-02-3.3	IRM-02-5	IRM-02-9	IRM-02-12	IRM-02-15	IRM-02-24
OUTPUT	DC VOLTAGE	3.3V	5V	9V	12V	15V	24V
	RATED CURRENT	600mA	400mA	222mA	167mA	133mA	83mA
	CURRENT RANGE	0 - 600mA	0 - 400mA	0 - 222mA	0 - 167mA	0 - 133mA	0 - 83mA
	RATED POWER	2W	2W	2W	2W	2W	2W
	RIPPLE & NOISE (max.) Note.2	150mVp-p	150mVp-p	150mVp-p	150mVp-p	200mVp-p	200mVp-p
	VOLTAGE TOLERANCE Note.3	±2.5%	±2.5%	±2.5%	±2.5%	±2.5%	±2.5%
	LINE REGULATION	±0.5%	±0.5%	±0.5%	±0.5%	±0.5%	±0.5%
	LOAD REGULATION	±0.5%	±0.5%	±0.5%	±0.5%	±0.5%	±0.5%
	SETUP, RISE TIME	600ms, 30ms/230VAC 600ms, 30ms/115VAC at full load					
	HOLD UP TIME (Typ.)	40ms/230VAC 12ms/115VAC at full load					
INPUT	VOLTAGE RANGE	85 - 305VAC 120 - 430VDC					
	FREQUENCY RANGE	47 - 63Hz					
	EFFICIENCY (Typ.)	66%	70%	72%	74%	75%	77%
	AC CURRENT (Typ.)	45mA/115VAC 30mA/230VAC 25mA/277VAC					
	INRUSH CURRENT (Typ.)	5A/115VAC 10A/230VAC					
	LEAKAGE CURRENT	< 0.25mA/277VAC					
PROTECTION	OVERLOAD	110% rated output power Protection type : Hiccup mode, recovers automatically after fault condition is removed					
	OVER VOLTAGE	3.8 - 4.9V	5.2 - 6.8V	10.3 - 12.2V	12.6 - 16.2V	15.7 - 20.3V	25.2 - 32.4V
ENVIRONMENT	WORKING TEMP.	-30 ~ +85 (Refer to "Derating Curve")					
	WORKING HUMIDITY	20 - 90% RH non-condensing					
	STORAGE TEMP., HUMIDITY	-40 ~ +100 , 10 ~ 95% RH					
	TEMP. COEFFICIENT	±0.03%/ (0 ~ 75)					
	VIBRATION	10 - 500Hz, 5G 10min./1cycle, period for 60min. each along X, Y, Z axes					
SAFETY & EMC	SAFETY STANDARDS	UL60950-1, TUV EN60950-1 approved, Meet IEC60601-1, EN60335-1, EN61558-1/-2-16					
	WITHSTAND VOLTAGE	I/P-O/P:3KVAC					
	ISOLATION RESISTANCE	I/P-O/P:100M Ohms / 500VDC / 25 / 70% RH					
	EMC EMISSION	Compliance to EN55022 (CISPR22) Class B, EN61000-3-2,-3					
	EMC IMMUNITY	Compliance to EN61000-4-2,3,4,5,6,8,11, EN55024, heavy industry level (surge L-N : 1KV), criteria A					
OTHERS	MTBF	1960Khrs min. MIL-HDBK-217F (25)					
	DIMENSION	PCB mounting style : 33.7*22.2*15mm (L*W*H) SMD style : 33.7*22.2*16mm (L*W*H)					
	PACKING	PCB mounting style : 0.019Kg; 640pcs/ 13.2 Kg/ 0.95CUFT SMD style : 0.019Kg; 640 pcs/ 13.2 Kg/ 0.95CUFT					
NOTE	<p>1. All parameters NOT specially mentioned are measured at 230VAC input, rated load and 25 of ambient temperature.</p> <p>2. Ripple & noise are measured at 20MHz of bandwidth by using a 12" twisted pair-wire terminated with a 0.1uf & 47uf parallel capacitor.</p> <p>3. Tolerance : includes set up tolerance, line regulation and load regulation.</p>						

Block Diagram

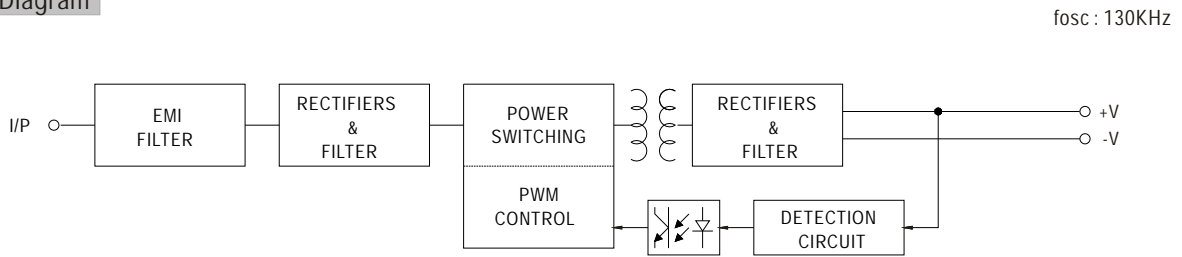

Derating Curve

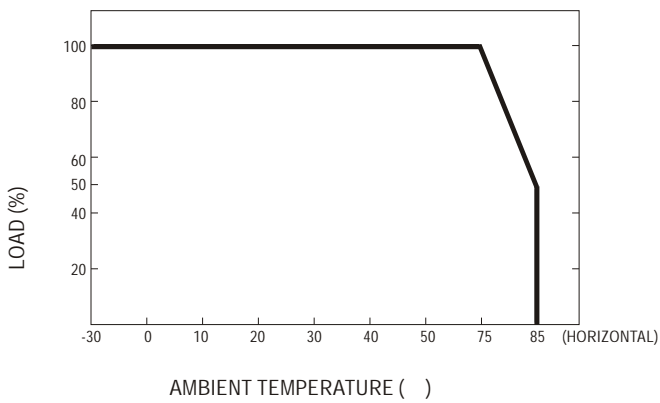

Static Characteristics

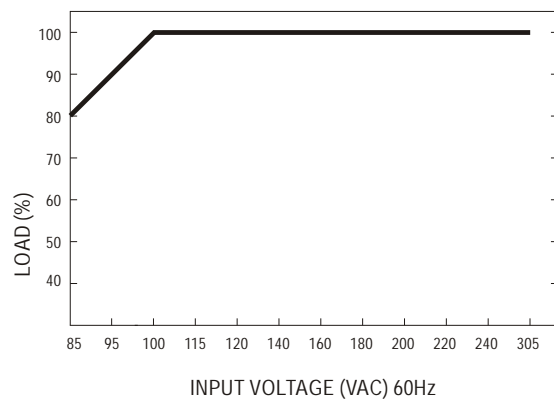

Mechanical Specification

PCB mounting style

Case No. IRM02 Unit: mm[inch]
Tolerance: $\pm 0.5[\pm 0.02]$
unless otherwise specified

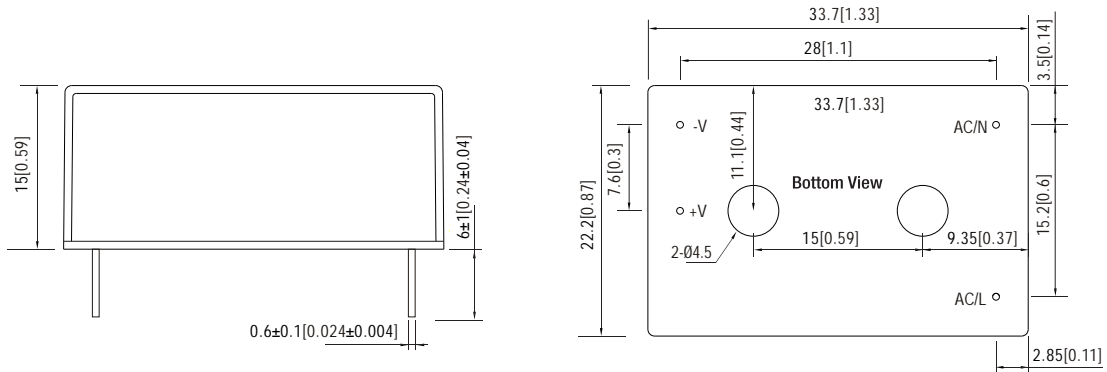

SMD style

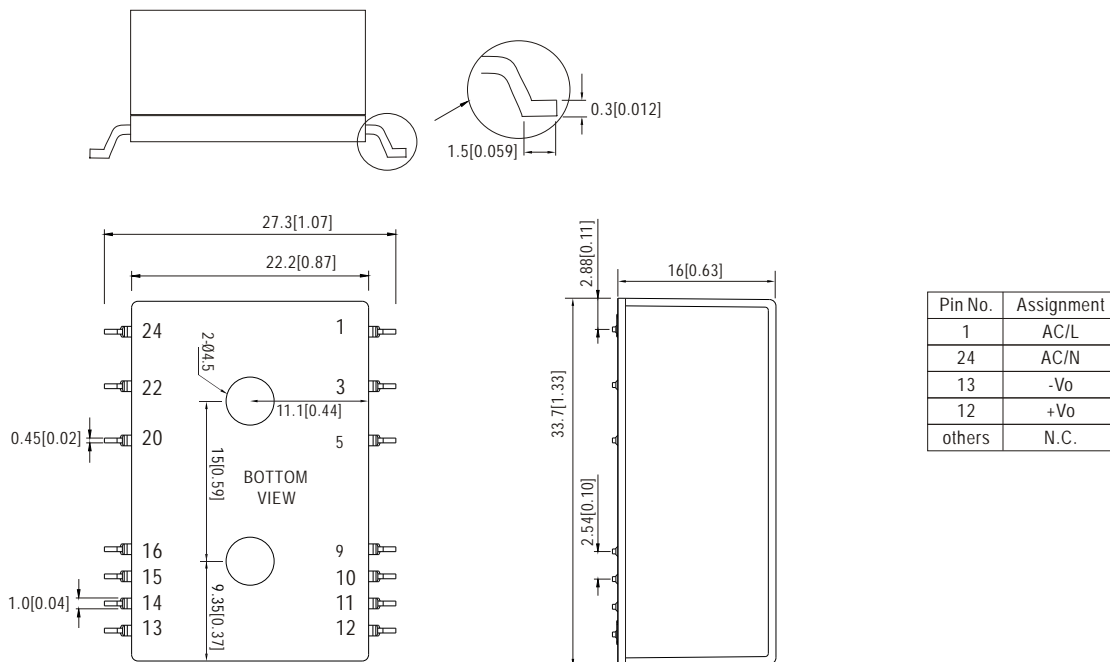

Recommended PCB Layout (for SMD style) (Reflow soldering method available)

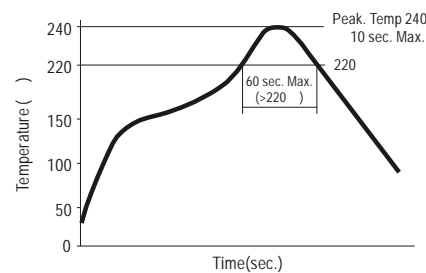
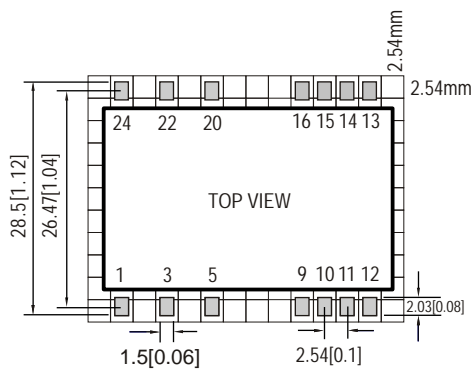

Remark : The curve applies only to the " Hot Air Reflow Soldering"