

DLM3022, DLM3032, DLM3052
Digital Oscilloscope
DLM3024, DLM3034, DLM3054
Mixed Signal Oscilloscope

U S E R ' S M A N U A L

Features Guide

Thank you for purchasing the DLM3022, DLM3032, or DLM3052 digital oscilloscope or the DLM3024, DLM3034, DLM3054 mixed signal oscilloscope.

This features guide contains useful information about the features of this instrument. To ensure correct use, please read this manual thoroughly before operation. After reading this manual, keep it in a safe place. The manuals for this instrument are listed on the next page. Please read all manuals.

Contact information of Yokogawa offices worldwide is provided on the following sheet.

Document No.	Description
PIM 113-01Z2	List of worldwide contacts

Notes

- The contents of this manual are subject to change without prior notice as a result of continuing improvements to the instrument's performance and functions. The figures given in this manual may differ from those that actually appear on your screen.
- Every effort has been made in the preparation of this manual to ensure the accuracy of its contents. However, should you have any questions or find any errors, please contact your nearest YOKOGAWA dealer.
- Copying or reproducing all or any part of the contents of this manual without the permission of YOKOGAWA is strictly prohibited.
- The TCP/IP software of this product and the documents concerning it have been developed/created by YOKOGAWA based on the BSD Networking Software, Release 1 that has been licensed from the Regents of the University of California.

Trademarks

- Microsoft, Internet Explorer, MS-DOS, Windows, Windows 7, Windows 8.1, and Windows 10 are registered trademarks or trademarks of Microsoft Corporation in the United States and/or other countries.
- Adobe and Acrobat are either registered trademarks or trademarks of Adobe Systems Incorporated.
- DLM is a registered trademark of Yokogawa Electric Corporation.
- In this manual, the ® and TM symbols do not accompany their respective registered trademark or trademark names.
- Other company and product names are trademarks or registered trademarks of their respective holders.

Revisions

- 1st Edition: November 2018

Manuals

The following manuals, including this one, are provided as manuals for this instrument. Please read all manuals.

Manual Title	Manual No.	Description
DLM3022, DLM3032, DLM3052 Digital oscilloscope	IM DLM3054-01EN	This document. The supplied CD contains the PDF file of this manual.
DLM3024, DLM3034, DLM3054 Mixed Signal Oscilloscope Features Guide		This manual explains all the instrument's features other than the communication interface features.
DLM3022, DLM3032, DLM3052 Digital oscilloscope	IM DLM3054-02EN	The supplied CD contains the PDF file of this manual.
DLM3024, DLM3034, DLM3054 Mixed Signal Oscilloscope User's Manual		The manual explains how to operate this instrument.
DLM3022, DLM3032, DLM3052 Digital oscilloscope	IM DLM3054-03EN	Provided as a printed manual.
DLM3024, DLM3034, DLM3054 Mixed Signal Oscilloscope Getting Started Guide		This guide explains the handling precautions, common operations, troubleshooting measures, and specifications of this instrument.
DLM3022, DLM3032, DLM3052 Digital oscilloscope	IM DLM3054-04EN	Provided as a printed manual.
DLM3024, DLM3034, DLM3054 Mixed Signal Oscilloscope Operation Guide		Explains the basic operations of this instrument. Operations are described in steps from "Preparation" to "Displaying Waveforms," "Measuring Waveforms," and "Saving Screen Captures."
DLM3022, DLM3032, DLM3052 Digital oscilloscope	IM DLM3054-17EN	The supplied CD contains the PDF file of this manual.
DLM3024, DLM3034, DLM3054 Mixed Signal Oscilloscope Communication Interface User's Manual		Explains the functions of the this instrument's communication interface, how to configure it, and how to control this instrument from a PC using the interface.
DLM3022, DLM3032, DLM3052 Digital Oscilloscope	IM DLM3054-92Z1	Document for China
DLM3024, DLM3034, DLM3054 Mixed Signal Oscilloscope		

The "EN" and "Z1" in the manual numbers are the language codes.

Manuals in the CD

The included CD (manual CD) contains the following English and Japanese manuals.

File Name	Manual No.	Description
Features Guide & Users Manual.pdf	IM DLM3054-01EN IM DLM3054-02EN	Features Guide and User's Manual
Communication Interface.pdf	IM DLM3054-17EN	Communication Interface User's Manual

Online Help

A help document in HTML format stored in the instrument. The contents of this document are the same as the *Features Guide* (IM DLM3054-01EN). For the operating procedure, see the *Getting Started Guide*, IM DLM3054-03EN.

Contents

	Manuals	ii
1	Vertical Axis (Analog Signal)	
	Turning the Display On and Off (Display)	1-1
	Vertical Scale (SCALE knob)	1-1
	Waveform Vertical Position (POSITION knob).....	1-2
	Input Coupling (Coupling)	1-3
	Probe Attenuation (Probe)	1-3
	Inverted Waveform Display (Invert)	1-4
	Linear Scaling (LinearScale).....	1-4
	Label Display (Label)	1-5
	Bandwidth Limit (Bandwidth)	1-5
	Offset (Offset)	1-5
2	Vertical Axis (Logic Signal)	
	Turning the Display On and Off (Display)	2-1
	Vertical Display Range (SCALE knob).....	2-1
	Vertical Position (POSITION knob).....	2-1
	Setting the Bits (Bit Setup).....	2-1
	Bus Display (Bus)	2-3
	State Display (State).....	2-4
	Setting the Display Order of Bits and the Bus (Bit Order).....	2-5
	Deskew (Deskew).....	2-5
3	Horizontal Axis (Time Axis)	
	Time Scale (TIME/DIV knob)	3-1
4	Triggering	
	Trigger mode (Trigger Mode)	4-1
	Trigger Type (Type).....	4-2
	Signal Type and Trigger Type Combinations	4-3
	Basic Trigger Settings.....	4-4
	Edge Trigger [EDGE]	4-4
	Edge OR Trigger [ENHANCED].....	4-8
	Pattern Trigger [ENHANCED].....	4-9
	Pulse Width Trigger [ENHANCED]	4-13
	Rise/Fall Time Trigger [ENHANCED].....	4-14
	Runt Trigger [ENHANCED].....	4-16
	Timeout Trigger [ENHANCED].....	4-17
	Window Trigger [ENHANCED].....	4-18
	Window OR Trigger [ENHANCED]	4-20
	Interval Trigger [ENHANCED].....	4-21
	Serial Bus Trigger [ENHANCED]	4-23

	FlexRay Bus Trigger [ENHANCED, option]	4-24
	CAN Bus Trigger [ENHANCED, option]	4-30
	CAN FD Bus Trigger [ENHANCED, option]	4-38
	LIN Bus Trigger [ENHANCED, option]	4-44
	CXPI Bus Trigger [ENHANCED, option]	4-48
	SENT Trigger [ENHANCED, option]	4-56
	UART Trigger [ENHANCED, option]	4-62
	I ² C Bus Trigger [ENHANCED, option]	4-64
	SPI Bus Trigger [ENHANCED, option]	4-69
	User-Defined Serial Bus Trigger [User Define, ENHANCED]	4-72
	TV Trigger [ENHANCED]	4-74
	Trigger B [B TRIG]	4-77
5	Executing Actions	
	Action Mode (Mode)	5-1
	Action to Execute When Conditions Are Met (Action)	5-1
	Number of Actions (Action Count/Nogo Count)	5-2
	Executing Action-on-Trigger or GO/NO-GO determination (Exec)	5-3
	GO/NO-GO Determination (Go/Nogo AND, Go/Nogo OR)	5-3
	Notes about Action	5-7
6	Waveform Acquisition	
	Record length (Record Length)	6-1
	Acquisition mode (Mode)	6-2
	High Resolution Mode (Hi Resolution)	6-3
	Sampling Mode (Sampling Mode)	6-4
	Waveform Acquisition (RUN/STOP)	6-5
	Acquiring the Waveform Once (SINGLE)	6-5
7	Display	
	Types of Windows	7-1
	Display Format (Format)	7-1
	Display Interpolation (Dot Connect)	7-2
	Graticule (Graticule)	7-3
	Scale Value Display (Scale Value)	7-3
	Waveform Intensity (Intensity)	7-3
	Accumulation (Accumulate)	7-4
8	Displaying XY Waveforms	
	Turning the XY Waveform Display On and Off (Display)	8-1
	X-Axis and Y-Axis Source Waveforms (X Trace/Y Trace)	8-1
	Configuring the Display (Display Setup)	8-1
	Display Source Window (Time Range)	8-2
	Display Area (T Range1/T Range2)	8-2
	Measurement (Measure Setup)	8-2

9	Computed and Reference Waveforms	
	Computation Mode (Mode)	9-1
	Computation Source Waveforms (Source1/Source2)	9-1
	Reference Waveforms	9-2
	Operators (Operation)	9-3
	Initial Point (Initial Point)	9-6
	Setting Labels and Units (Label/Unit)	9-6
	Scaling (Ranging)	9-7
	User-Defined Computation (User Define, Option)	9-7
10	FFT	
	Turning the FFT On or Off (Display)	10-1
	Analysis Source Waveform (Trace)	10-1
	FFT Conditions (FFT Setup)	10-2
	Number of FFT Points (FFT Point)	10-3
	Analysis Range (Time Range)	10-3
	Scale Value (Display Setup)	10-4
	Cursor Measurement (Measure Setup)	10-4
11	Cursor Measurement	
	Turning Cursor Measurement On and Off (Display)	11-1
	Cursor Mode (Type)	11-1
	Measurement Source Waveform (Trace)	11-1
	ΔT Cursors (ΔT)	11-2
	ΔV Cursors (ΔV)	11-2
	ΔT & ΔV Cursors (ΔT & ΔV)	11-3
	Marker Cursors (Marker)	11-3
	Angle Cursors (Degree)	11-4
	Moving the Cursors (Cursor/Marker)	11-4
	Cursor Jumping (Cursor Jump/T Cursor Jump)	11-5
12	Automated Measurement of Waveform Parameters	
	Turning Automated Measurement On or Off (Mode)	12-1
	Source Window (Time Range)	12-1
	Measurement Time Period (T Range1/T Range2)	12-1
	Automated Measurement of Waveform Parameters	12-2
	Statistics (Statistics)	12-7
	Enhanced Parameter Measurement (Enhanced)	12-12
	Notes about Automated Measurement of Waveform Parameters	12-13

13	Zooming in on Waveforms	
	Turning the Zoom Windows On or Off (Display)	13-1
	Display Format (Format)	13-1
	Displaying the Main Window (Main).....	13-2
	Auto Scrolling (Auto Scroll)	13-2
	Zoom Source Waveforms (Trace).....	13-2
	Zoom Factor (ZOOM knob).....	13-2
	Zoom Position (Z1 Position, Z2 Position).....	13-3
	Vertical Zoom (Vertical Zoom).....	13-3
14	Searching Waveforms	
	Search Source Waveform.....	14-1
	Search Type (Type).....	14-1
	Search Conditions (Condition Setup).....	14-4
	Displaying Detected Waveforms (Display Setup)	14-7
	Search Skip (Skip Mode)	14-7
	Search Range (Start/End Point)	14-8
	Detected Point number (Pattern No.).....	14-8
	Executing a Search (Search).....	14-8
15	Analyzing and Searching Serial Bus Signals	
	Turning the Analysis and Search Feature On or Off (Display).....	15-1
	Serial Bus Signal Type (Type).....	15-2
	Bus Setup (Setup).....	15-2
	Search Setup (Search)	15-2
	Zoom Position (Z1 Position, Z2 Position).....	15-3
	Decoded Display (Decode).....	15-3
	List Display (List).....	15-4
	Trend Display (Trend)	15-4
	Saving the Analysis Results.....	15-4
	Analyzing and Searching FlexRay Bus Signals (Option).....	15-5
	Analyzing and Searching CAN Bus Signals (Option).....	15-7
	Analyzing and Searching CAN FD Bus Signals (Option).....	15-9
	Analyzing and Searching LIN Bus Signals (Option).....	15-14
	Analyzing and Searching CXPI Bus Signals (Option).....	15-17
	Analyzing and Searching SENT Signals (Option).....	15-23
	Analyzing and Searching UART Signals (Option).....	15-28
	Analyzing and Searching I ² C Bus Signals (Option).....	15-31
	Analyzing and Searching SPI Bus Signals (Option)	15-33
	Analyzing and Searching User-Defined Serial Bus Signals (User Define)	15-35

16	Waveform Histogram Display	
	Turning the Histograms On or Off (Display).....	16-1
	Source Waveform (Trace).....	16-1
	Source Axis (Type).....	16-1
	Range Setup (Range Setup).....	16-1
	Measurement (Measure Setup).....	16-2
17	Power Supply Analysis Feature (Power Analysis and Power Measurement, Option)	
	Overview of the Power Supply Analysis Feature.....	17-1
	Switching Loss Analysis (SW Loss).....	17-2
	Safe Operating Area Analysis (SOA).....	17-7
	Harmonic Analysis (Harmonics).....	17-8
	Measuring Inrush Current by Computing the Joule Integral (I ² t).....	17-12
	Power Measurement (Power Measurement).....	17-14
18	Displaying and Searching History Waveforms	
	Display Mode (Mode).....	18-2
	Average (Average).....	18-2
	Highlighting (Select No.).....	18-2
	Display Range (Start/End No.).....	18-2
	List of Timestamps (List).....	18-2
	Searching History Waveforms (Search).....	18-3
	Replay (Replay).....	18-4
	Notes on Using the History Feature.....	18-4
19	Printing and Saving Screen Captures	
	Destination Type (Print To).....	19-1
	Printing on the Built-in Printer (BuiltIn) (Option).....	19-2
	Printing on a USB Printer (USB).....	19-2
	Printing on a Network Printer (Network).....	19-4
	Saving Screen Captures to Files (File).....	19-5
	Printing and Saving Screen Captures to Multiple Destinations (Multi).....	19-7
20	Saving and Loading Data	
	Storage Device You Can Save and Load From.....	20-1
	Saving Data (Save).....	20-2
	Saving Waveform Data (Waveform).....	20-2
	Saving Setup Data (Setup).....	20-5
	Saving Other Types of Data (Others).....	20-5
	Serial Bus Analysis Results (Others - Serial Bus (FlexRay/CAN/CAN FD/LIN/CXPI)).....	20-8
	Serial Bus Analysis Results (Others - Serial Bus (SENT/UART/I ² C/SPI)).....	20-11
	Loading Data (Load).....	20-14
	File Operations (Utility).....	20-16

21	Ethernet Communication (Network)	
	TCP/IP(TCP/IP)	21-2
	FTP Server (FTP Server).....	21-3
	Mail (Mail)	21-4
	Network Drive (Net Drive).....	21-5
	Network Printer (Net Print).....	21-6
	SNTP (SNTP)	21-6
22	Other Features	
	Auto Setup (AUTO SETUP).....	22-1
	Default Settings (DEFAULT SETUP)	22-2
	Snapshot (SNAP SHOT).....	22-2
	Clear Trace (CLEAR TRACE).....	22-3
	Calibration (Calibration)	22-3
	Remote Control (Remote Control)	22-4
	System Configuration (System Configuration).....	22-6
	Overview (Overview).....	22-9
	Self-Test (Self Test).....	22-10
	Touch Panel (TOUCH).....	22-10
	Appendix	
	Appendix 1 How to Calculate the Area of a Waveform.....	App-1
	Appendix 2 User-Defined Computation	App-3
	FFT Function	App-7
	Appendix 3 ASCII Data File Format	App-10
	Appendix 4 TCP and UDP Port Numbers.....	App-11
	Appendix 5 How Power Measurement Items Are Determined	App-12
	Appendix 6 Trigger and Detected Points of SENT Signals	App-13
	Appendix 7 Firmware Version and New Features	App-14

Index

1 Vertical Axis (Analog Signal)

You can configure the vertical scale, vertical position, input coupling, probe attenuation, linear scaling, and bandwidth limit settings of the CH1 through CH4 input signals.

If you are using a probe that is compatible with this instrument's probe interface, the instrument automatically configures the input impedance (50 Ω or 1 M Ω) and the probe attenuation.

Turning the Display On and Off (Display)

Select whether show or hide each channel's input signal waveform.

- ON: The waveform is shown.
- OFF: The waveform is hidden.

Vertical Scale (SCALE knob)

The vertical scale is used to adjust the displayed waveform amplitude so that you can easily view signals. Set the vertical scale by voltage per grid square (V/div) or current per grid square (A/div) on the screen.

Set the vertical scale using the SCALE knob for each channel.

The SCALE knob is shared between channels. Press the CH1 to CH4 keys to select the channel that you want to set the vertical scale for. The LED between the SCALE and POSITION knobs illuminates in the color assigned to the selected channel (yellow, green, magenta, or cyan).

Setup Example

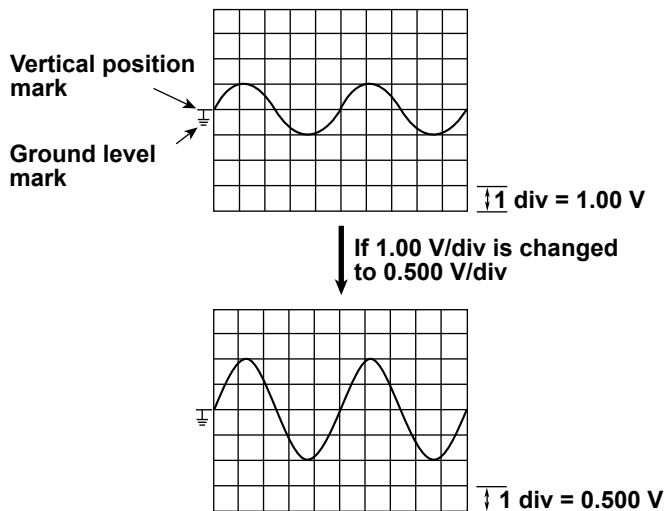

1 Vertical Axis (Analog Signal)



- The SCALE knob has a push switch. If you push the SCALE knob, the FINE indicator illuminates, and you can set the vertical scale with higher resolution.

Measurement Resolution and Effective Data Range

This instrument uses an 8-bit A/D converter to sample the input signal. The instrument's effective data range is 250 levels (LSB). The effective data range is ± 5 divisions from the center of the screen, but only up to ± 4 divisions of data can be displayed on the screen. If you move the vertical position after stopping waveform acquisition, you can change the display range of the effective data.

Vertical Scale Setting

To measure the voltage or current with high accuracy, increase the vertical scale so that the input signal is measured with the largest possible amplitude within the effective data range.

If you display multiple waveforms (set the vertical scale to a low value) so that they do not overlap without dividing the screen, the resolution of the A/D converter cannot be used to its fullest potential. To make accurate measurements, divide the screen, and set the vertical scale of each waveform to a high value.

Waveform Vertical Position (POSITION knob)

You can move the display position (vertical position) of each waveform in the range of ± 4 divisions.

The vertical scale changes with the vertical position (mark) at the center.

Set the vertical position using the POSITION knob for each channel.

The POSITION knob is shared between channels. Press the CH1 to CH4 keys to select the channel that you want to set the vertical position for. The key corresponding to the selected channel illuminates, and the LED between the SCALE and POSITION knobs illuminates in the color assigned to the selected channel (yellow, green, magenta, or cyan).

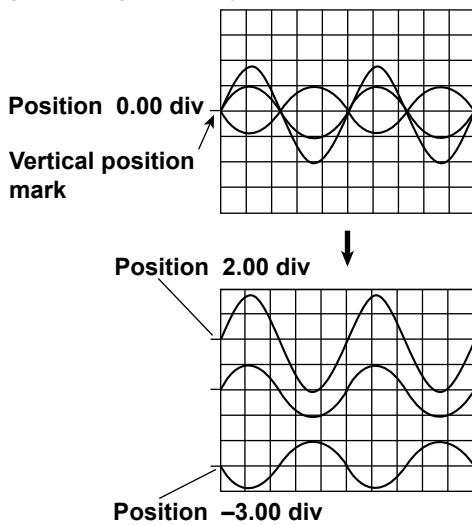

After stopping signal acquisition, data falling outside the measurement range when you change the vertical position is handled as overflow data.

Input Coupling (Coupling)

You can change the coupling used to input analog signals into the vertical (voltage) control circuit. Select one of the following input coupling options.

AC

Displays only the AC component of the input signal. The input impedance is $1\text{ M}\Omega$.

DC

Displays both the AC and DC components of the input signal. The input impedance is $1\text{ M}\Omega$.

DC50

Displays both the AC and DC components of the input signal. The input impedance is $50\ \Omega$. Pay attention because the maximum input voltage (current) is small.

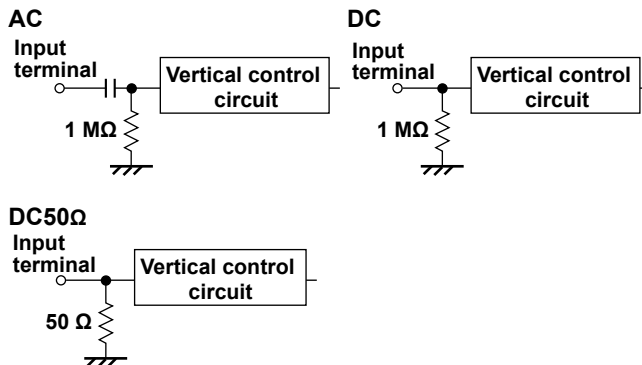

Probe Attenuation (Probe)

When using a probe, the instrument's attenuation ratio setting must be aligned with the probe attenuation so that the voltage (current) and scale values are displayed correctly. Set the attenuation ratio to match the probe attenuation.

Probe Type (Type)

Select the type of probe to set the attenuation ratio of.

- Voltage: Voltage probe
- Current: Current probe

Attenuation Ratio (Attenuation)

Select the attenuation ratio from the following.

Voltage probe

0.001: 1, 0.002: 1, 0.005: 1, 0.01: 1, 0.02: 1, 0.05: 1, 0.1: 1, 0.2: 1, 0.5: 1, 1: 1, 2: 1, 5: 1, 10: 1, 20: 1, 50: 1, 100: 1, 200: 1, 500: 1, 1000: 1, 2000: 1

Current probe

0.001 A: 1 V, 0.002 A: 1 V, 0.005 A: 1 V, 0.01 A: 1 V, 0.02 A: 1 V, 0.05 A: 1 V, 0.1 A: 1 V, 0.2 A: 1 V, 0.5 A: 1 V, 1 A: 1 V, 2 A: 1 V, 5 A: 1 V, 10 A: 1 V, 20 A: 1 V, 50 A: 1 V, 100 A: 1 V, 200 A: 1 V, 500 A: 1 V, 1000 A: 1 V, 2000 A: 1 V



Using a probe has the following advantages.

- Prevents the disturbance of the voltage and current of the circuit being measured.
- Allows signals to be applied with no distortion.
- Expands the voltage range that the instrument can measure.

1 Vertical Axis (Analog Signal)

Automatic Zero Adjustment of Current Probes (Probe Zero CAL)

Automatic zero adjustment of current probes can be executed when all the following conditions are met.

- A current probe compatible with the instrument's probe interface is connected to the signal input terminal.
- The input coupling is set to DC.



If the current probe's residual offset is large, an error may occur when automatic zero adjustment is executed. If this happens, adjust the current probe's residual offset to zero.

Demagnetization and Automatic Zero Adjustment of Current Probes (DEMAG & ZeroCAL)

Demagnetization and automatic zero adjustment of current probes can be executed when all the following conditions are met.

- A current probe with a YOKOGAWA probe interface (e.g., PBC100, PBC050) is connected to the signal input terminal.
- The input coupling is set to DC.



When you demagnetize and perform automatic zero adjustment on a current probe, do not clamp the conductor. If you demagnetize a current probe while the conductor is clamped, the current that flows through the conductor as a result of demagnetization may damage components of the DUT circuitry.

Deskew (Deskew)

You can adjust for the time offsets (skew) between the CH1 to CH4 signals, which are caused by the use of different types of probes, and monitor the signals. You can adjust each channels (CH1 to CH4) separately. Selectable range: -1000.0 ns to 1000.0 ns (0.01 ns resolution)

Inverted Waveform Display (Invert)

Waveforms can be inverted across the waveform vertical position. Only the display is inverted. Cursor measurements, automated measurement of waveform parameters, and computation functions are performed on the non-inverted waveform. The trigger function is also executed on the non-inverted waveform.

Linear Scaling (LinearScale)

The following computation is performed based on the specified scaling coefficient A and offset B, and cursor measurement values and automated measurement values of waveform parameters are displayed using the scaled values. You can assign units to scaled values.

By using this function, you can multiply the voltage divider ratio of the external voltage divider to the measured values of this instrument and convert measured voltage into current.

$$Y(\text{Unit})=AX + B$$

X: Value before scaling

Y: Value after scaling

Turning Linear Scaling On and Off (Mode)

Set whether to perform linear scaling.

- ON: Linear scaling is performed.
- OFF: Linear scaling is not performed.

Unit (Unit)

You can set the unit using up to four alphanumeric characters.

Scaling Coefficient (A) and Offset (B)

The selectable ranges of scaling coefficient A and offset B are as follows:

Selectable of A and B	-10.000E+30 to +10.000E+30	
Default settings	A	1.0000E+00
	B	0.0000E+00

Label Display (Label)

You can assign labels using up to 8 characters to be displayed.

Turning Label Display On and Off (Display)

- ON: Shows labels
- OFF: Hides labels

Label (Name)

Set the label name when you set the label display to ON.

Bandwidth Limit (Bandwidth)

You can set a upper bandwidth limit on the analog signal for each channel.

This allows you to observe waveforms with components above the specified frequency removed.

Select the frequencies to limit from the following.

FULL (no bandwidth limit), 200 MHz, 100 MHz, 20 MHz, 10 MHz, 5 MHz, 2 MHz, 1 MHz, 500 kHz, 250 kHz, 125 kHz, 62.5 kHz, 32 kHz, 16 kHz, 8 kHz



When high resolution mode is on, the bandwidth limit is set at 200 MHz even when bandwidth limit is set to FULL.

Offset (Offset)

If you set an offset when measuring an analog signal that is riding on top of a given voltage (or current), the given voltage (or current) is subtracted from the input signal. This allows you to only view the changes in the signal at a higher vertical scale setting.

You can set the offset for each channel.

Selectable Range for Voltage

Input Coupling	Voltage Scale (With probe = 1:1)	Selectable Offset Voltage Range
AC/DC	500 μ V/div to 50 mV/div	-1.0 V to 1.0 V
	0.1 V/div to 0.5 V/div	-10.0 V to 10.0 V
	1 V/div to 10 V/div	-100.0 V to 100.0 V
DC50	500 μ V/div to 50 mV/div	-1.0 V to 1.0 V
	0.1 V/div to 1 V/div	-5.0 V to 5.0 V

You can set the offset in 0.01 mV steps. For 500 μ V/div, you can set the offset in 5 μ V steps.

Resetting the Offset

Press the RESET key to set the offset value to 0 V.

Offset Cancel (Offset Cancel)

You can set whether or not to apply the specified offset to various measured values.

The offset-cancel feature ON/OFF setting applies to all channels. The default setting is off.

- **ON**

The specified offset is applied to the result of cursor measurements, computations, and automated measurement of waveform parameters. The offset is subtracted from the input signal, and various measurements are performed. The vertical position is set to zero.

- **OFF**

The specified offset is not applied to the result of cursor measurements, computations, and automated measurement of waveform parameters. The offset is not subtracted from the input signal, and various measurements are performed. The vertical position on the screen corresponds to the offset.

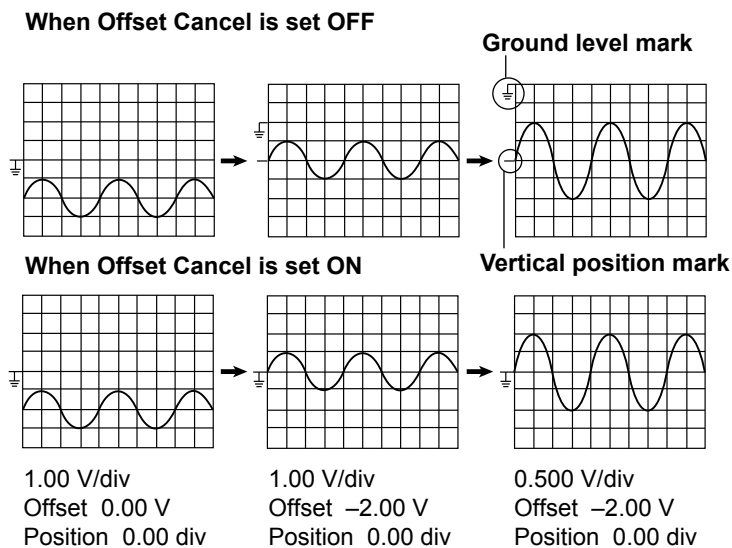

- The offset setting applies to all input coupling settings (AC, DC, DC50).
- If you change the probe attenuation, the vertical scale settings change the values that have been scaled with the new attenuation ratio.
- The offset value does not change even if you change the vertical scale. However, if the offset value goes outside the selectable range, the offset is set to the maximum or minimum value in the vertical scale range. If you do not change the offset and set the vertical scale back to its original value, the offset returns to its original value.

2 Vertical Axis (Logic Signal)

You can configure the vertical display range, bus display on/off, threshold level, and other settings for the input (logic) signals.

Logic signals are applied through the logic signal input port (8 bits) on the front panel.

Turning the Display On and Off (Display)

Select whether to show or hide the logic signal waveform. When shown, logic signal waveforms are displayed in the CH4 waveform display area.

- ON: The waveforms are shown.
- OFF: The waveforms are hidden.

Vertical Display Range (SCALE knob)

You can set the logic signal's vertical display range to one of three levels.

Press LOGIC, and use the SCALE knob to set the range while the key is illuminated.

Vertical Position (POSITION knob)

You can move the logic signal's vertical display position within ± 4 divisions.

Press LOGIC, and use the POSITION knob to set the position while the key is illuminated.

Setting the Bits (Bit Setup)

For each bit, you can turn on or off the display, set the label (name), and threshold level (Threshold, Level).

You can set whether to set the threshold level separately for each bit (ThresholdType) ► [See here](#), and noise rejection (Noise Rejection) ► [See here](#).

Turning the Display On or Off

For each bit, you can turn the display on or off. You can also turn on or off the display of all bits at once.

Label (Name)

Set the label that appears when the bit display is turned on using up to eight characters.

2 Vertical Axis (Logic Signal)

Threshold Level (Threshold, Level)

Set the level (threshold level) of the logic signal to detect, high or low.

Preset (Threshold)

Selecting from the following presets automatically sets the threshold level.

If you select User, you can set the level in the range of -10 V to 10 V in 0.1 V steps.

CMOS(5 V)	2.5 V
CMOS(3.3 V)	1.6 V
CMOS(2.5 V)	1.2 V
CMOS(1.8 V)	0.9 V
ECL	-1.3 V
User	-10.0 V to 10.0 V

The selectable range varies depending on the logic probe that you use.

- Model 701988: ± 40 V (in 0.05 V steps)
- Model 701989: ± 6 V (in 0.05 V steps)

Setting Whether to Set the Threshold Level Separately for Each Bit (ThresholdType)

When the 701989 logic probe is connected, you can select whether to set the threshold level separately for each bit.

- All: Set the threshold level of all bits to the same value
- Each: Set the threshold level for each bit





When you connect one of the following logic probes to the instrument, Threshold Type is set automatically.

- Model 701988: Fixed to All. The setup menu does not appear.
 - Model 701989: Each (select All or Each)
-

Noise Rejection (Noise Rejection)

When the 701989 logic probe is connected, you can apply hysteresis to the threshold level so that the high and low states do not change as long as the signal level changes within that range.

Select the hysteresis from one of the following settings below.

	Hysteresis of approximately 100 mV around the threshold level*
	Hysteresis of approximately 250 mV around the threshold level*

* The above values are approximate values. They are not strictly warranted.

The hysteresis is fixed at approximately 80 mV for the 701988 logic probe, so the setup menu will not appear.

Bus Display (Bus)

Bits 0 to 7 can be displayed as bus signals.

Turning the Display On and Off (Display)

You can turn the bus display on and off. If you turn it on, a bus display appears according to the specified bus bit assignments (Assignment), label (Name), and format (Format).

- ON: The bus display is shown.
- OFF: The bus display is hidden.

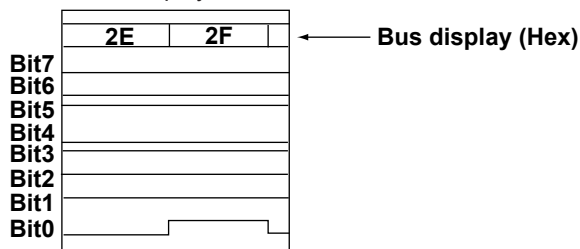

Bus Bit Assignments (Assignment)

Set which bits to assign to the bits on the bus (from the MSB to LSB). The bit assignments here are used to measure the bus value during cursor measurement.

Edit Menu

In the assignment edit menu, you can select a position in the bus to assign a bit, delete an assigned bit, and so on.

Bits

Select the bit to assign from the group of bits.

Label (Name)

Set the label that appears when the bus display is turned on using up to eight characters.

Format (Format)

Select the format for displaying the bus.

- Bin: Binary notation
- Hex: Hexadecimal notation

State Display (State)

The state display shows logic signal data that has been sampled on the edge of the signal specified as the clock source. Even when the input signal changes, the state is retained until the clock source edge changes.

Display ON/OFF (State)

You can turn the state display on and off. If you turn it on, the state is shown according to the specified clock source (Clock), detection level (Threshold), and clock source polarity (Polarity).

- ON: The state display is shown.
- OFF: The state display is hidden.

State Display Example

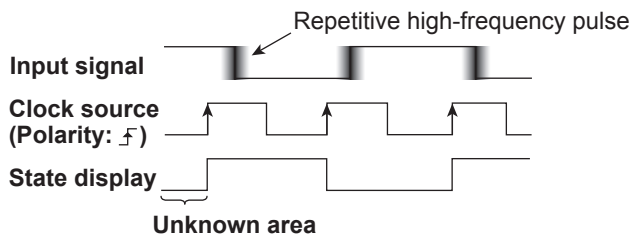

Clock Source (Clock)

Select from the following.
CH1 to CH3, LOGIC (Bit0 to Bit7)

Clock Source Polarity (Polarity)

Select the clock source polarity.

f	When the clock source changes from low to high
\bar{f}	When the clock source changes from high to low
$f\bar{f}$	When the clock source changes from low to high or from high to low

Detection Level (Threshold)

Set the level for detecting edges. Set this when the clock source is set to CH1 to CH3.
Range: ± 5 div

Hysteresis (Hysteresis)

You can apply a hysteresis to the detection level so that edges are not detected on small changes. Set this when the clock source is set to CH1 to CH3.

Selectable range: 0.3 div to 8.0 div

Resolution: 0.1 div



- When the state display is ON, Math/Ref4 cannot be used.
 - When the clock source is set to LOGIC, the source bit waveform is shown as-is.
-

Assignment(Assignment)

You can set whether to apply the state display separately for the bus and each bit. You can also set them all at once.

Source Bit (Source Bit)

Set this when the clock source is set to LOGIC. Select from the following.

Bit0 to Bit7

Setting the Display Order of Bits and the Bus (Bit Order)

Set the vertical display order of bits and the bus on the screen. Select the bit or bus to move and then specify the destination.

Deskew (Deskew)

You can adjust for the time offsets (skew) between the logic signal and other signals, which are caused by the use of different types of probes, to measure signals. Deskewing of the logic signal is performed on all eight bits collectively.

Range: -1000.0 ns to 1000.0 ns (0.01 ns resolution)

3 Horizontal Axis (Time Axis)

Time Scale (TIME/DIV knob)

Set the time scale as a length of time per grid division. You can adjust the amount of time that you want to display waveforms for by setting the time scale. Because the horizontal display range is 10 divisions, the amount of time displayed is equal to the TIME/DIV setting \times 10. The selectable range is 1 ns/division to 500 s/division.

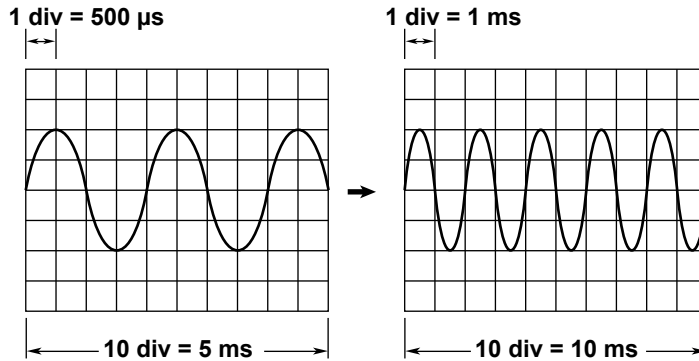

Relationship between the Time Scale, Record Length, and Sample Rate

The relationship between the time scale, record length, and sample rate is as follows:

When the record length and the time scale are set so that the sample rate is at the maximum rate, if you decrease the time scale, the record length is reduced.

$$\text{Sample rate} = \text{Record length} / (\text{time scale [s/div]} \times 10 [\text{div}])$$

When you change the time scale, the sample rate and the record length stored in the acquisition memory also change. For details, see appendix 1, "Relationship between the Time Scale, Record Length, and Sample Rate" in the *Getting Started Guide*, IM DLM3054-03EN.

Time Scale and Roll Mode Display

When the following conditions are met, if you set the time scale to one of the settings in the following table, the instrument switches to roll mode display.

- The acquisition mode is not set to Average.
- The trigger mode is Auto, Auto Level, or Single.

Record Length	Time Scale
2.5 Mpoints or less	100 ms/div to 500 s/div
5 Mpoints	200 ms/div to 500 s/div
12.5 Mpoints	500 ms/div to 500 s/div
25 Mpoints	1 s/div to 500 s/div
50 Mpoints	2 s/div to 500 s/div
125 Mpoints	5 s/div to 500 s/div
250 Mpoints	10 s/div to 500 s/div
500 Mpoints	20 s/div to 500 s/div

3 Horizontal Axis (Time Axis)

Roll mode display

In roll mode, the displayed waveform is not updated using triggers. Rather, the oldest data is deleted as new data is acquired, and the waveform flows from the right to the left of the screen. This mode is useful for observing low-frequency signals or signals that change slowly.

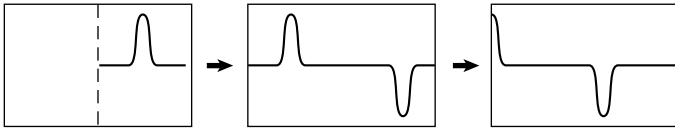

About the roll-mode display

- The display is set to roll mode also when the trigger mode is set to single, but the roll mode display stops when the instrument triggers.
 - If the record length is 1.25 or longer, measured time values such as ΔT and Freq appear after you stop waveform acquisition using the RUN/STOP key.
 - If the record length is set such that waveform acquisition operates in single mode,* computed waveforms (MATH waveforms nor automated measurement values of waveform parameters are not shown while waveform acquisition is in progress. Waveforms and computed values are shown when a trigger occurs and the roll mode display stops.
 - * The record length that causes waveform acquisition to operate in single mode varies depending on whether a memory option is available. If no memory option is available, the record length is 25 Mpoints or more. If the /M1 option is available, it is 50 Mpoints or more. If the /M2 option is available, it is 125 Mpoints or more.
 - The instrument will not display computed waveforms that have been generated through user-defined computation while it is acquiring waveforms. The instrument will display the computed waveforms after it stops acquiring waveforms.
-

4 Triggering

Triggers are events used to display waveforms. A trigger occurs when the specified trigger condition is met, and a waveform is displayed on the screen.

Trigger mode (Trigger Mode)

The trigger mode determines the conditions for updating the displayed waveforms. There are five trigger modes.

Auto Mode (Auto)

If the trigger conditions are met within a timeout period, the instrument updates the displayed waveforms on each trigger occurrence. If not, this instrument automatically updates the displayed waveforms. The timeout period is approximately 100 ms or the time corresponding to 10 divisions on the time axis, whichever is larger. If the time axis is set to a value that would cause the display to switch to roll mode, roll mode display will be enabled.

Auto Level Mode (Auto Level)

If a trigger occurs before a timeout, the instrument updates the waveform in the same way that it does in Auto mode.

If a trigger does not occur before a timeout, the instrument automatically changes the trigger level to the center value of the trigger source amplitude, triggers on that value, and updates the displayed waveform. Auto Level mode is valid when the trigger source is set to a channel from CH1 to CH4. For all other cases, Auto Level mode operates in the same way as Auto mode.

If the time axis is set to a value that would cause the display to switch to roll mode, roll mode display will be enabled.

Normal Mode (Normal)

The instrument updates the waveform display only when the trigger conditions are met. If no triggers occur, the display is not updated. If you want to view waveforms that the instrument cannot trigger on, or if you want to check the ground level, use Auto mode.

N Single Mode (N Single)

The instrument acquires signals each time the trigger conditions are met until a specified number of signals have been acquired, and then displays all of the acquired signals. If no triggers occur, the display is not updated.

Single Mode

When the trigger conditions are met, the instrument updates the displayed waveform once and stops signal acquisition. When you press SINGLE on the front panel, the instrument acquires waveforms in Single mode.

▶ [See here.](#)



-
- The trigger mode setting applies to all trigger types.
 - The trigger conditions that were used to acquire the displayed waveform appear at the upper right of the screen.
 - If you set the trigger mode to Auto when using a trigger combination, the timeout only applies to the trigger A trigger conditions.
 - If you are acquiring waveforms in Single mode when using repetitive sampling mode, waveform acquisition is repeated until the required number of display points is collected, and then acquisition stops.
 - Repetitive sampling mode is not available in N Single mode. If you select N Single mode when repetitive sampling mode is selected, the sampling mode changes to interpolation.
-

Trigger Type (Type)

The following trigger types are available.

EDGE

- [Edge trigger](#): Triggers on the edges of a single trigger source (a simple trigger).

ENHANCED

- [Edge OR trigger](#): Triggers on the OR logic of multiple trigger source edges.
 - [Pattern trigger](#): Triggers on a pattern match, pattern mismatch, or pattern duration.
 - [Pulse Width trigger](#): Triggers on a trigger source pulse-width condition (such as More than, Less than, and Between).
 - [Rise/Fall Time trigger](#): Triggers on duration of the trigger rise or time (such as More than, Less than).
 - [Runt trigger](#): Triggers on a runt pulse or the duration of a runt pulse.
 - [Timeout trigger](#): Triggers when a timeout occurs before the end edge of a pulse.
 - [Window trigger](#): Triggers when the signal enters or exits from a specified range (window) or on the duration in which the signal stays within the range or outside the range.
 - [Window OR trigger](#): Triggers on the OR logic of multiple trigger sources entering or exiting from each specified range (window).
 - [Interval trigger](#): Triggers when the time condition of the signal period is met.
 - [Serial trigger*](#): (FlexRay, CAN, CAN FD, LIN, CXPI, SENT, UART, I2C, SPI, User Define): Triggers on various serial bus signal conditions.
 - [TV trigger](#): (NTSC, PAL, SDTV, HDTV, UserdefTV): Triggers on various TV signal conditions.
- * The FlexRay, CAN, CAN FD, LIN, CXPI, SENT, UART, I2C, and SPI bus triggers are options available only for 4-channel models.



-
- The active trigger, EDGE or ENHANCED, is the one whose key is illuminated.
 - You can also configure the instrument to trigger on the combination of trigger A and trigger B, where trigger A is the trigger configured using the EDGE or ENHANCED key, and trigger B is the trigger configured using the B TRIG key. The combination trigger is active when the B TRIG key is illuminated.

▶ [See here.](#)

Forced Trigger [FORCE TRIG]

Pressing FORCE TRIG (SHIFT+B TRIG) on the front panel forces the instrument to trigger even when trigger conditions are not met.

Signal Type and Trigger Type Combinations

The signal type (analog or logic) determines what trigger types you can use.

	CH1 to CH4	LOGIC	Mixed
Edge	Yes	Yes	-
Edge OR	Yes	No	No
Pattern	Yes	Yes	Yes
Pulse Width	Yes	Yes	-
Rise/Fall Time	Yes	No	-
Runt	Yes	No	-
Timeout	Yes	Yes	-
Window	Yes	No	-
Window OR	Yes	No	No
Interval	Yes	Yes	-
Serial			
FlexRay	Yes	No	-
CAN	Yes	No	-
CAN FD	Yes	No	-
LIN	Yes	No	-
CXPI	Yes	No	-
SENT	Yes	Yes	-
UART	Yes	Yes	-
I2C	Yes	Yes	Yes
SPI	Yes	Yes	Yes
User Define	Yes	No	No
TV	Yes	No	-



- CH4 and LOGIC cannot be used simultaneously in waveform display, measurement, analysis, or search, but they can be used simultaneously as trigger sources in triggering.
- When the maximum record length is in use, CH2, CH4, and LOGIC cannot acquire waveforms, but they can be used as trigger sources.

Basic Trigger Settings

- **Trigger source:** The trigger source signal.
- **Trigger slope:** Specifies which edge, rising or falling, the instrument will trigger on.
- **Trigger level:** The trigger determination level.
- **Trigger position:** The position where the trigger point will be displayed.
- **Trigger delay:** The delay from the trigger point.
- **Trigger hold-off:** The amount of time to hold off the next trigger detection.
- **HF rejection:** For rejecting high-frequency components in the trigger source.
- **Noise rejection:** The trigger level margin (the instrument does not trigger on changes in the signal level within this margin).

Edge Trigger [EDGE]

The instrument triggers on trigger source edges (rising or falling edges). A change in the waveform that causes it to pass through a trigger level is called an *edge*.

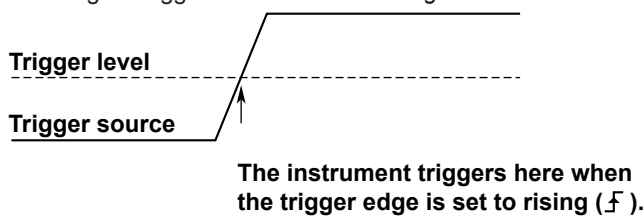

Trigger Source (Source)

Trigger source refers to the signal used to determine whether the specified trigger conditions are met. Select from the following.

CH1 to CH4

A signal that is received through front-panel input terminals 1 to 4 (the number of input terminals varies depending on the model).

LOGIC (On models with the logic signal input port)

A signal that is received through a front-panel LOGIC signal input port.

A signal received through a LOGIC input signal port is sampled at 1.25 GHz internally and used as a trigger source.

You need to select the source bit (Bit0 to Bit7).

EXT (external trigger signal)

The external signal that is received through the rear-panel TRIG IN terminal.

LINE (the instrument's power source)

The instrument only triggers on the rising edge.

The settings that you need to configure vary depending on the selected trigger source as follows:

	CH1 to CH4	LOGIC (Bit0 to Bit7)	EXT	LINE
Slope	Yes	Yes	Yes	-
HF Rejection	Yes	-	-	-
Noise Rejection	Yes	-	-	-
Probe	-	-	Yes	-
Range	-	-	Yes	-
Source Bit	-	Yes	-	-
Level	Yes	Yes	Yes	-

Trigger Level (Level)

Trigger level refers to the signal level used as a reference for detecting a signal's rising and falling edges or high and low states. With simple triggers such as the edge trigger, the instrument triggers when the trigger source level passes through the specified trigger level.

The analog signals (CH1 to CH4) and the logic signal (LOGIC) have different selectable trigger level ranges.

Analog Signals

Selectable range: 8 divisions within the screen

Resolution: 0.01 divisions (for example: 0.02 mV when the time scale is set to 2 mV/division)

Logic Signals (On models with the logic signal input port)

The selectable range varies depending on the logic probe that you use.

- Model 701988: ± 40 V (0.05 V resolution)
- Model 701989: ± 6 V (0.05 V resolution)



- The trigger level is set using the jog shuttle. If a single trigger source is used (Edge, Pulse Width, Rise/Fall Time, Runt, Timeout, Window, Interval, FlexRay, CAN, CAN FD, LIN, CXPI, SENT, UART, TV), you can also use the front-panel LEVEL knob to set the trigger level.
- When the front-panel LEVEL knob is valid, you can press it to automatically set the trigger level.
- If the jog shuttle is controlling the trigger level, you can press the RESET key to reset the trigger level to the current offset voltage.
- The trigger level is shared between trigger A and trigger B. If the trigger type of one of the triggers has two levels (upper level and lower level) and that of the other has one level, the center value of the two levels and the single level are shared.
- The selectable range of threshold levels used to detect logic signal bit states is the same as the selectable range of the [source bit](#) trigger level. How you can set the bit levels varies depending on the logic probe that you are using.
Model 701988: The level setting applies to all bits.
Model 701989: The level is set for each bit separately.
- You can also set the level of each bit of the logic signal using Level on the bit setup menu of the LOGIC key (the level is shared). If you change the level on the trigger menu, the Level value on the bit setup menu of the LOGIC key will also change.

Trigger Slope (Slope/ Polarity)

Slope refers to the movement of the signal from a low level to a high level (rising edge) or from a high level to a low level (falling edge). When a slope is used as one of the trigger conditions, it is called a *trigger slope*.

The following trigger slope settings are available for triggering the instrument.

	When the trigger source changes from a level below the trigger level to a level above the trigger level (rising) (Slope)
	When the trigger source changes from a level above the trigger level to a level below the trigger level (falling) (Slope)
	When a rising or falling edge is detected (Slope)
	When the trigger source level enters the specified voltage range (Polarity)
	When the trigger source level goes outside of the specified voltage range (Polarity)

- * / is only selectable when the trigger source is an analog signal.

4 Triggering

HF Rejection (HF Rejection)

Use HF rejection when you want to remove the high-frequency components (above approximately 15 kHz or 20 MHz) from the trigger signal. You can select from one of the settings below. You cannot use HF rejection when the trigger source is set to LOGIC, EXT, or LINE.

OFF, 15kHz, 20MHz

Noise Rejection (Noise Rejection)

Noise rejection establishes a trigger level margin (hysteresis) so that the instrument does not trigger if the signal level change is within the margin.

Select the hysteresis from one of the following settings below. You cannot use noise rejection when the trigger source is set to EXT or LINE.

<input type="checkbox"/>	Approximately 0.3 divisions* of hysteresis around the trigger level
<input type="checkbox"/>	Approximately 0.5 divisions* of hysteresis around the trigger level
<input type="checkbox"/>	Approximately 1 divisions* of hysteresis around the trigger level

* The above values are approximate values. They are not strictly warranted.

When the trigger source is LOGIC, you can apply hysteresis to the threshold level so that the high and low states do not change as long as the signal level changes within that range.

If the 701989 logic probe is connected, select the hysteresis from one of the following settings below.

<input type="checkbox"/>	Hysteresis of approximately 100 mV around the threshold level*
<input type="checkbox"/>	Hysteresis of approximately 250 mV around the threshold level*

* The above values are approximate values. They are not strictly warranted.

The hysteresis is fixed at approximately 80 mV for the 701988 logic probe, so the setup menu will not appear.

Probe Attenuation (Probe)

When you set the trigger source to EXT, set the probe attenuation (1:1 or 10:1).

Input Range (Range)

When the trigger source is set to EXT, select the input range.

Select selectable ranges vary depending on the probe attenuation setting.

- 1:1: ± 2 V or ± 20 V
- 10:1: ± 20 V or ± 200 V

Trigger Position (POSITION knob)

When you move the trigger position, the ratio of the displayed data before the trigger point (the pre-trigger section) to the data after the trigger point (the post-trigger point) changes.

When the trigger delay is 0 s, the trigger point and trigger positions coincide.

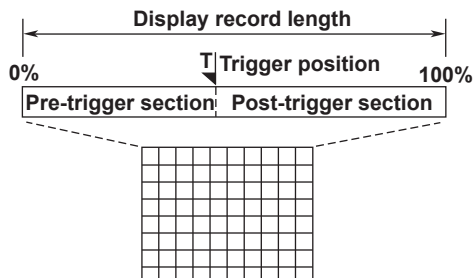

Selectable range: 0 to 100% of the display record length

Resolution: 1%



- If you change the trigger position when waveform acquisition is stopped, the instrument re-displays waveforms using the new position.
- The time values of cursor measurements are based on the trigger position. If you change the trigger position, the measured values will change (except during roll mode display).
- If you change the TIME/DIV setting, the location of the trigger position does not change.

Trigger Delay (DELAY)

The instrument normally displays waveforms before and after the trigger point. You can set a trigger delay to display waveforms that the instrument has acquired a specified amount of time after the trigger occurrence.

Selectable range: $-(\text{post-trigger time}^*)$ to 10 s

Resolution: $(1 \div \text{sample rate})/10$ or 10 ps, whichever is longer

- * Post-trigger time: The time between the trigger position and the right edge of the main window

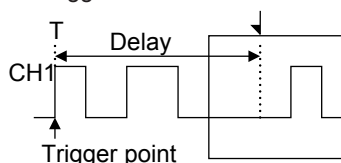

T: Mark that indicates the trigger point

↓: Mark that indicates the trigger position

Delay Cancel (Delay Cancel)

You can select whether or not to apply the specified delay to the time measurement values.

The default setting is ON.

- ON: Measures time values by setting the trigger position to 0 s (the delay is not applied to time measurement values).
- OFF: Measures time values by setting the trigger point to 0 s (the delay is applied to time measurement values).



The delay value is retained even if you change the TIME/DIV setting.

Trigger Hold-off (Holdoff)

The trigger hold-off feature temporarily stops the detection of the next trigger once a trigger has occurred. This feature is useful when you want to change the signal acquisition interval, such as when you are observing a PCM code or other pulse train signal or when you are using the history feature.

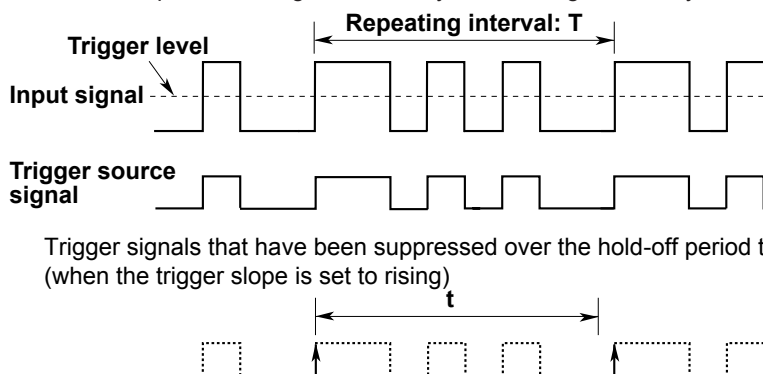

Selectable range: 20 ns to 10.0000 s (the default value is 20 ns)

Resolution: 5 ns

4 Triggering



- In repetitive sampling mode, waveform updating may slow down. If this happens, reduce the hold-off time setting.
 - To trigger with the hold-off time set longer than the timeout period of auto trigger and auto level trigger, set the trigger mode to Normal. The timeout period of auto trigger and auto level trigger is approximately 100 ms or the time corresponding to 10 divisions on the time axis, whichever is larger.
 - When combination trigger is in use, hold-off is applied only to trigger A.
-

Edge OR Trigger [ENHANCED]

The instrument triggers on the OR logic of multiple trigger source edges.

Example

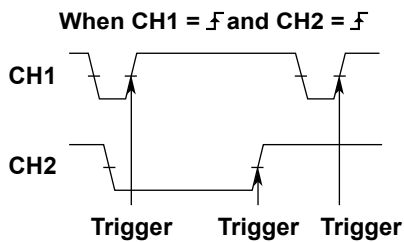

Trigger Source (CH1/CH2/CH3/CH4)

Set the trigger slope for each channel. There is also a feature (All soft key) for applying the same settings to CH1 to CH4.

\uparrow	When the trigger source changes from a level below the trigger level to a level above the trigger level (rising)
\downarrow	When the trigger source changes from a level above the trigger level to a level below the trigger level (falling)
\updownarrow	When a rising or falling edge is detected



LOGIC, EXT, and LINE signals cannot be used as the trigger source of Edge OR triggers.

Trigger Level (Level), HF Rejection (HF Rejection)

Noise Rejection (Noise Rejection)

Set these items for each trigger source.

These items are the same as those of the edge trigger.

▶ [See here.](#)

Trigger Position (POSITION), Trigger Delay (DELAY), Trigger Hold-Off (Holdoff)

These items are the same as those of the edge trigger.

▶ [See here.](#)

Pattern Trigger [ENHANCED]

The instrument triggers on whether the trigger source pattern matches the specified pattern or on the pattern duration. You can also use a clock source.

When a Clock Source Is Specified

Example 1

The results of comparing the combination (Logic) of the trigger source signal pattern (Pattern) and the specified pattern are sampled on the edges of the clock source, and the instrument triggers at the point of change in the comparison results (Enter or Exit of the trigger condition (Condition)).

Clock source: CH3 \bar{f}

Pattern: CH1 = H, CH2 = L, other channels = X, Logic = AND

Condition: Enter

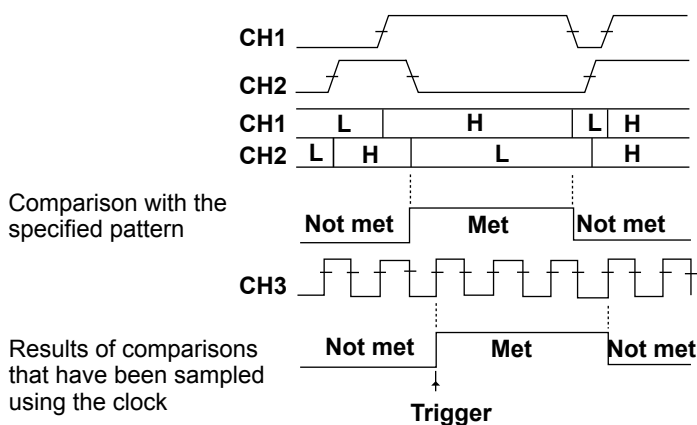

Example 2

When the result of comparing the combination (Logic) of the trigger source signal pattern (Pattern) and the specified pattern is true or false as specified by the trigger condition (Condition), the instrument triggers on the edge of the clock source.

Clock source: CH3 \bar{f}

Pattern: CH1 = H, CH2 = L, other channels = X, Logic = AND

Condition: True

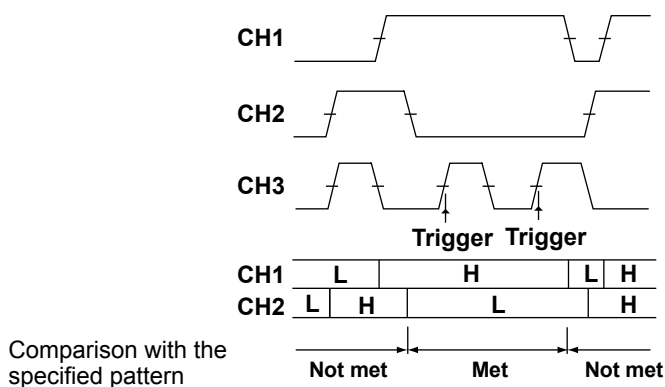

4 Triggering

When a Clock Source Is Not Specified

Example 1

The instrument triggers at the point of change in the results (Enter or Exit of the trigger condition (Condition)) of comparing the combination (Logic) of the trigger source signal pattern (Pattern) and the specified pattern are sampled on the edges of the clock source.

Clock source: None
Pattern: CH1 = H, CH2 = L, other channels = X, Logic = AND
Condition: Enter

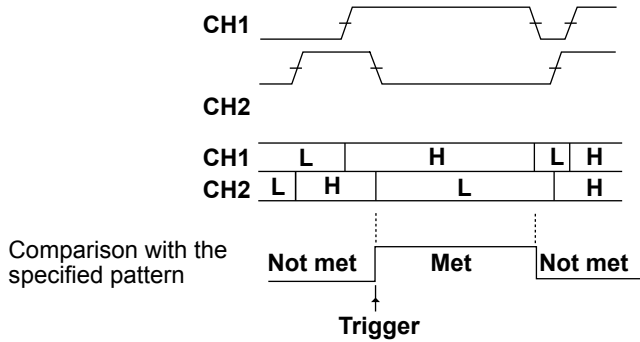

Example 2

The instrument triggers when the relationship between the duration the result (Enter or Exit of the trigger condition (Condition)) of comparing the combination (Logic) of the trigger source signal pattern (Pattern) and the reference time meets the specified time condition (Time Qualification). When the time condition is set to timeout, the instrument triggers when a timeout occurs.

Clock source: None
Pattern: CH1 = H, CH2 = L, other channels = X, Logic = AND
Condition: False
Time Qualification: More than($t > \text{Time}$)

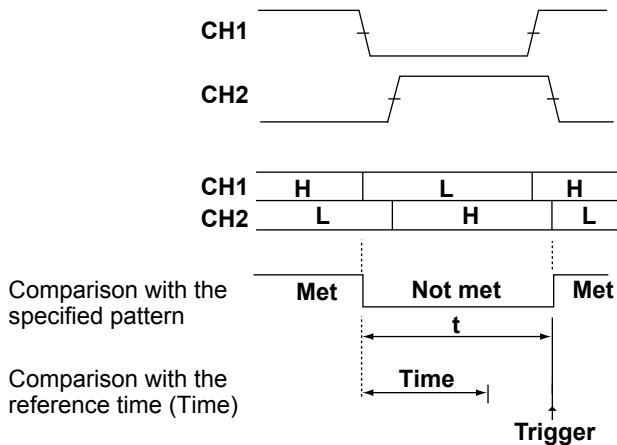

Examples of Various Time Conditions

The following figure illustrates the trigger points when various time conditions are met.

More than, Less than, Inside, Outside: Triggers at the end point of the trigger condition achievement time (t)

Timeout: Triggers when a timeout occurs

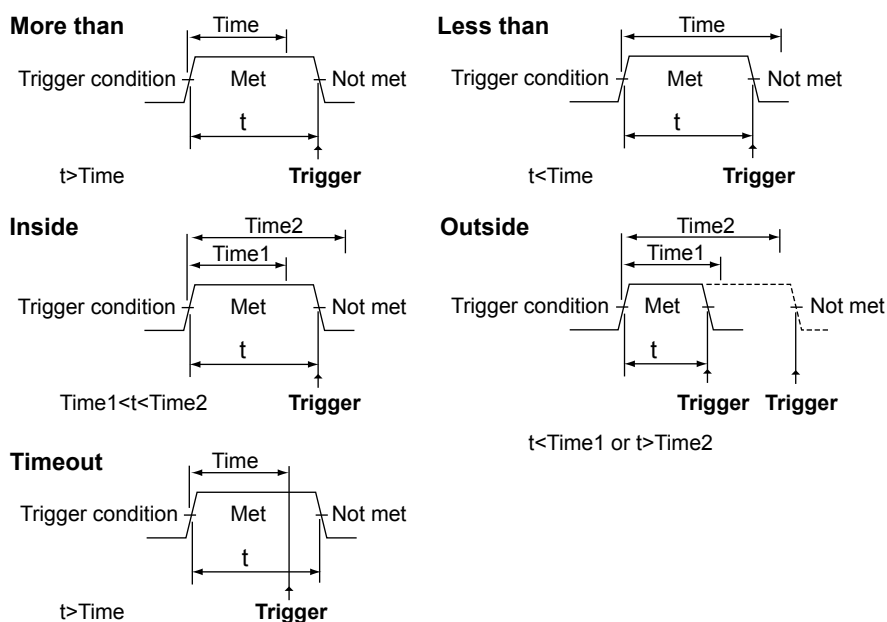

Clock Source (Clock)

Select the clock source from the following: (The selectable settings vary depending on the model.) If you select LOGIC, set the source bit.

- CH1 to CH4
- LOGIC (Bit0 to Bit7)
- None (not specify a clock source)

Clock Source Slope

Select the clock source slope.

\uparrow	When the source changes from a level below the specified level to a level above the specified level (rising)
\downarrow	When the source changes from a level above the specified level to a level below the specified level (falling)
\updownarrow	When a rising or falling edge is detected



You cannot set a pattern to a signal that is set as the clock source.

Comparison Condition

Trigger Source Pattern (Pattern)

Select the trigger sources (CH1 to CH4, Bit0 to Bit7, excluding the clock source) from one of the following settings.

H	When the signal level is high
L	When the signal level is low
X	Don't care.

4 Triggering

Combination (Logic)

Select the trigger source combination from one of the settings below.

AND	Allows triggering when all the trigger source signal patterns match the specified pattern
OR	Allows triggering when any of the trigger source signal patterns matches the specified pattern

Trigger Condition (Condition)

Select the condition for judging the results of comparing the trigger source signal pattern and the specified pattern.

With a Clock Source

Enter	Detects changes in the comparison results from a mismatched condition to a matched condition at the clock source sampling timing. The instrument triggers at the point of change.
Exit	Detects changes in the comparison results from a matched condition to a mismatched condition at the clock source sampling timing. The instrument triggers at the point of change.
True	Detects matches in the comparison results. The instrument triggers at the clock source sampling points while the match is true.
False	Detects mismatches in the comparison results. The instrument triggers at the clock source sampling points while the mismatch is true.

Without a Clock Source

Enter	Detects changes in the comparison results from a mismatched condition to a matched condition. The instrument triggers at the point of change.
Exit	Detects changes in the comparison results from a matched condition to a mismatched condition. The instrument triggers at the point of change.
True	Detects matches in the comparison conditions. The trigger timing varies depending on time conditions, explained later.
False	Detects mismatches in the comparison conditions. The trigger timing varies depending on time conditions, explained later.

Time Condition (Time Qualification)

Set what kind of relationship must be established between the trigger condition achievement time and the specified reference time (Time, Time1, Time2). You can set this when the clock source is set to None and the trigger condition (Condition) is true or false.

More than	When the trigger condition achievement time (t) is longer than the specified reference time (Time)
Less than	When the trigger condition achievement time (t) is shorter than the specified reference time (Time)
Inside	When the trigger condition achievement time (t) is longer than reference time Time1 and shorter than reference time Time2.
Outside	When the trigger condition achievement time (t) is longer than reference time Time1 and shorter than reference time or Time2
Timeout	When the trigger condition achievement time (t) is longer than the specified reference time (Time)

Reference Times (Time or Time1 and Time2)

The selectable range for Time or Time1 and Time2 varies depending on the time condition. You can set this when the clock source is set to None and the trigger condition (Condition) is true or false.

More than	Time: 2 ns to 10 s
Less than	Time: 4 ns to 10 s
Inside	Time1: 2 ns to [10 s - 2 ns], Time2: 4 ns to 10 s
Outside	Time1: 2 ns to [10 s - 2 ns], Time2: 4 ns to 10 s
Timeout	Time: 4 ns to 10 s

Resolution: 2 ns

Level (Level), HF Rejection (HF Rejection), Noise Rejection (Noise Rejection)

Set these items for the trigger source.

These items are the same as those of the edge trigger.

▶ [See here.](#)

Trigger Position (POSITION), Trigger Delay (DELAY), Trigger Hold-Off (Holdoff)

These items are the same as those of the edge trigger.

▶ [See here.](#)



- The instrument may not trigger properly if the spacing between signals or the time detection width is less than 1 ns.
- Under standard operating conditions, the time accuracy immediately after calibration is as follows:
 CH1 to CH4: $\pm(0.002\%$ of setting + 450 ps)
 LOGIC: $\pm(0.002\%$ of setting + 1 ns)

Pulse Width Trigger [ENHANCED]

The instrument triggers when the relationship between the trigger source's pulse width and the specified reference times meets the selected time condition. The examples are the same as those given under "Examples of Various Time Conditions" for the pattern trigger [ENHANCED].

Trigger Source (Source)

Select the trigger source from the following: CH1 to CH4 or LOGIC. (The selectable settings vary depending on the model.) If you set the trigger source to LOGIC, set the source bit.

Configure the polarity, HF rejection, noise rejection, and trigger level settings for the selected trigger source.

Polarity (Polarity)

Select which trigger source polarity will cause the comparison of the pulse width with the reference times. The trigger source polarity is based on the trigger level.

	When the signal level is high
	When the signal level is low

Time Condition (Time Qualification)

Set what kind of relationship must be established between the trigger source's pulse width and the specified reference times (Time, Time1, and Time2) for the instrument to trigger.

More than	When the pulse width is longer than the specified reference time (Time)
Less than	When the pulse width is shorter than the specified reference time (Time)
Inside	When the pulse width is longer than Time1 but shorter than Time2
Outside	When the pulse width is shorter than Time1 or longer than Time2
Timeout	When the pulse width is longer than the specified reference time (Time)

Reference Times (Time or Time1 and Time2)

The selectable range for Time or Time1 and Time2 varies depending on the time condition.

More than	Time: 2 ns to 10 s
Less than	Time: 4 ns to 10 s
Inside	Time1: 2 ns to [10 s - 2 ns], Time2: 4 ns to 10 s
Outside	Time1: 2 ns to [10 s - 2 ns], Time2: 4 ns to 10 s
Timeout	Time: 4 ns to 10 s

Resolution: 2 ns

4 Triggering

Level (Level), HF Rejection (HF Rejection), Noise Rejection (Noise Rejection)

Set these items for the trigger source.

These items are the same as those of the edge trigger.

▶ [See here.](#)

Trigger Position (POSITION), Trigger Delay (DELAY), Trigger Hold-Off (Holdoff)

These items are the same as those of the edge trigger.

▶ [See here.](#)



- The instrument may not trigger properly if the spacing between signals or the time detection width is less than 1 ns.
- Under standard operating conditions, the time accuracy immediately after calibration is as follows:
CH1 to CH4: $\pm(0.002\% \text{ of setting} + 450 \text{ ps})$
LOGIC: $\pm(0.002\% \text{ of setting} + 1 \text{ ns})$

Rise/Fall Time Trigger [ENHANCED]

The instrument triggers when the relationship between the trigger source's rising or falling times and the specified reference times meets the selected time condition.

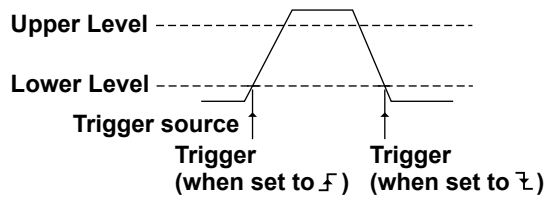

Example

Source: CH1 \bar{F}
Time Qualification: Less than ($t < \text{Time}$)

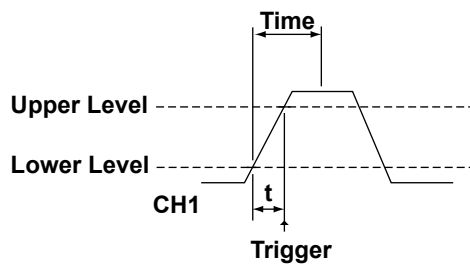

Trigger Source (Source)

Select the trigger source from the following: CH1 to CH4. (The selectable settings vary depending on the model.) Configure the polarity, HF rejection, noise rejection, and trigger level settings for the selected trigger source.

Polarity (Polarity)

Select which trigger source polarity will cause the comparison of the pulse width with the reference times. The trigger source polarity is based on the trigger level.

\bar{F}	When the trigger level passes through the lower limit and then reaches the upper limit (rising)
\bar{L}	When the trigger level passes through the upper limit and then reaches the lower limit (falling)
\bar{t}	When a rising or falling edge is detected

Time Condition (Time Qualification)

Set what kind of relationship must be established between the trigger source's rising or falling times and the specified reference times (Time1 and Time2) for the instrument to trigger.

More than	When the rise time or fall time is longer than the specified reference time
Less than	When the rise time or fall time is shorter than the specified reference time
Inside	When the rise time or fall time is longer than reference time Time1 and shorter than reference time Time2.
Outside	When the rise time or fall time is shorter than reference time Time1 or longer than reference time Time2.

Reference Times (Time or Time1 and Time2)

The selectable range for Time or Time1 and Time2 varies depending on the time condition.

More than	Time: 2 ns to 10 s
Less than	Time: 4 ns to 10 s
Inside	Time1: 2 ns to [10 s - 2 ns], Time2: 4 ns to 10 s
Outside	Time1: 2 ns to [10 s - 2 ns], Time2: 4 ns to 10 s

Resolution: 2 ns

Reference Range (Upper Level/Lower Level)

Set the upper and lower levels of the reference range.

HF Rejection (HF Rejection)

Set this item for the trigger source.

This item is the same as those of the edge trigger.

▶ [See here.](#)

Trigger Position (POSITION), Trigger Delay (DELAY), Trigger Hold-Off (Holdoff)

These items are the same as those of the edge trigger.

▶ [See here.](#)



- The instrument may not trigger properly if the spacing between signals or the time detection width is less than 1 ns.
- Under standard operating conditions, the time accuracy immediately after calibration is $\pm(0.002\%$ of setting + 450 ps).

Runt Trigger [ENHANCED]

Runt pulses* are used to trigger the instrument. The instrument also triggers when the relationship between the runt pulse width and the specified reference times meets the selected time condition.

* A signal that passes through the first threshold level but returns to the original level without passing the other threshold level.

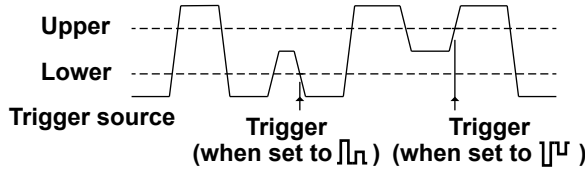

Example

Source: CH1, Polarity: [L]
Time Qualification: Less than ($t < \text{Time}$)

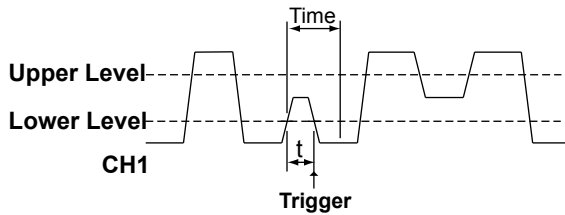

Trigger Source (Source)

Select the trigger source from the following: CH1 to CH4. (The selectable settings vary depending on the model.) Configure the polarity, HF rejection, noise rejection, and trigger level settings for the selected trigger source.

Polarity (Polarity)

Select which trigger source polarity will cause the comparison of the pulse width with the reference times. The trigger source polarity is based on the trigger level.

[L]	When the trigger source is Pos (positive polarity)
[U]	When the trigger source is Neg (negative polarity)
[L/U]	When the trigger source is Pos (positive polarity) or Neg (negative polarity)

Time Condition (Time Qualification)

Set what kind of relationship must be established between the trigger source's pulse width and the specified reference times (Time, Time1, and Time2) for the instrument to trigger.

None	No reference time
More than	When the pulse width is longer than the specified reference time (Time)
Less than	When the pulse width is shorter than the specified reference time (Time)
Inside	When the pulse width is longer than Time1 but shorter than Time2
Outside	When the pulse width is shorter than Time1 or longer than Time2

Reference Times (Time or Time1 and Time2)

Range

The selectable range for Time or Time1 and Time2 varies depending on the time condition.

More than	Time: 2 ns to 10 s
Less than	Time: 4 ns to 10 s
Inside	Time1: 2 ns to [10 s - 2 ns], Time2: 4 ns to 10 s
Outside	Time1: 2 ns to [10 s - 2 ns], Time2: 4 ns to 10 s

Resolution: 2 ns

Reference Range (Upper Level/Lower Level)

Set the upper and lower levels of the reference range.

HF Rejection (HF Rejection), Noise Rejection (Noise Rejection)

Set these items for the trigger source.

These items are the same as those of the edge trigger.

▶ [See here.](#)

Trigger Position (POSITION), Trigger Delay (DELAY), Trigger Hold-Off (Holdoff)

These items are the same as those of the edge trigger.

▶ [See here.](#)



- The instrument may not trigger properly if the spacing between signals or the time detection width is less than 1 ns.
- Under standard operating conditions, the time accuracy immediately after calibration is $\pm(0.002\%$ of setting + 450 ps).

Timeout Trigger [ENHANCED]

The instrument triggers when a timeout occurs before the end edge of a pulse.

Example

Trigger source: CH1, (Both)

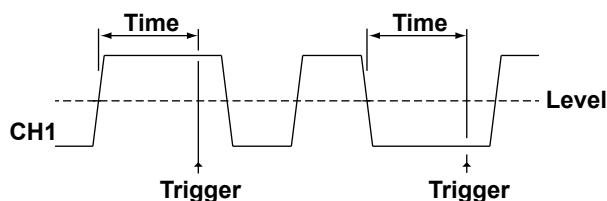
**Trigger Source (Source)**

Select the trigger source from the following: CH1 to CH4 or LOGIC. (The selectable settings vary depending on the model.) If you set the trigger source to LOGIC, set the source bit.

Configure the polarity, HF rejection, noise rejection, and trigger level settings for the selected trigger source.

Polarity (Polarity)

Select which trigger source polarity will cause the comparison with the timeout period. The trigger source polarity is based on the trigger level.

	Pos (positive polarity)
	Neg (negative polarity)
	Pos (positive polarity) or Neg (negative polarity)

Timeout Period (Time)

Selectable range: 4ns to 10s

Resolution: 2 ns

Level (Level), HF Rejection (HF Rejection), Noise Rejection (Noise Rejection)

Set these items for the trigger source.

These items are the same as those of the edge trigger.

▶ [See here.](#)

4 Triggering

Trigger Position (POSITION), Trigger Delay (DELAY), Trigger Hold-Off (Holdoff)

These items are the same as those of the edge trigger.

▶ [See here.](#)



- The instrument may not trigger properly if the spacing between signals or the time detection width is less than 1 ns.
- Under standard operating conditions, the time accuracy immediately after calibration is as follows:
CH1 to CH4: $\pm(0.002\% \text{ of setting} + 450 \text{ ps})$
LOGIC: $\pm(0.002\% \text{ of setting} + 1 \text{ ns})$

Window Trigger [ENHANCED]

Window refers to a range set by upper level and lower level. The instrument triggers when the waveform moves from inside (IN) the window to outside (OUT) the window or from outside (OUT) to the inside (IN) or when the relationship between the time that the waveform stays in the IN or OUT condition and the specified reference time meets the selected time condition. When the time condition is timeout, the instrument triggers when a timeout occurs.

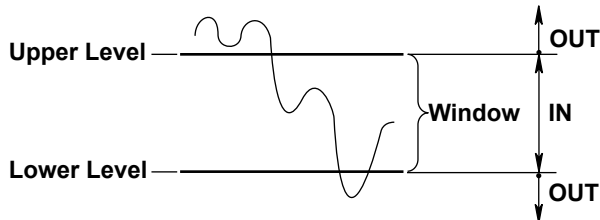

Example

Source: CH1, Polarity:
Time Qualification: Less than ($t < \text{Time}$)

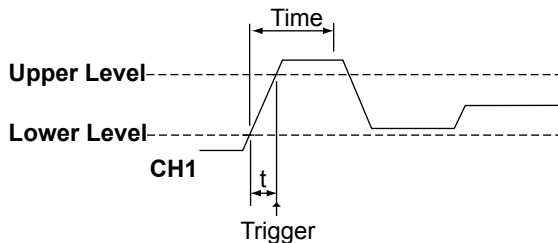

Trigger Source (Source)

Select the trigger source from the following: CH1 to CH4. (The selectable settings vary depending on the model.) Configure the trigger slope, HF rejection, noise rejection, and trigger level settings for the selected trigger source.

Polarity (Polarity)

Select the polarity from the following. The polarity varies depending on the time condition.

- Without a time condition

When the trigger source level enters the specified range (window)

When the trigger source level goes outside of the specified range (window)

- With a time condition

When the trigger source level remains inside the specified range (window)

When the trigger source level remains outside the specified range (window)

Reference Range (Upper Level/Lower Level)

Set the upper and lower levels of the reference range.

Time Condition (Time Qualification)

Set whether the trigger source must be inside (IN) the specified range or outside (OUT) the specified range (Window) and what kind of relationship must be established with the specified reference times (Time or Time1 and Time2) for the instrument to trigger.

None	Without a time condition
More than	When the time that the waveform stays inside or outside the window is longer than the specified reference time (Time)
Less than	When the time that the waveform stays inside or outside the window is shorter than the specified reference time (Time)
Inside	When the time that the waveform stays inside or outside the window is longer than reference time Time1 and shorter than reference time Time2.
Outside	When the time that the waveform stays inside or outside the window is shorter than reference time Time1 or longer than reference time Time2.
Timeout	When the time that the waveform stays inside or outside the window is longer than the specified reference time (Time)

Reference Times (Time or Time1 and Time2)

The selectable range for Time or Time1 and Time2 varies depending on the time condition.

More than	Time: 2 ns to 10 s
Less than	Time: 4 ns to 10 s
Inside	Time1: 2 ns to [10 s - 2 ns], Time2: 4 ns to 10 s
Outside	Time1: 2 ns to [10 s - 2 ns], Time2: 4 ns to 10 s
Timeout	Time1: 4 ns to 10 s

Resolution: 2 ns

HF Rejection (HF Rejection), Noise Rejection (Noise Rejection)

Set these items for the trigger source.

These items are the same as those of the edge trigger.

▶ [See here.](#)

Trigger Position (POSITION), Trigger Delay (DELAY), Trigger Hold-Off (Holdoff)

These items are the same as those of the edge trigger.

▶ [See here.](#)



- The instrument may not trigger properly if the spacing between signals or the time detection width is less than 1 ns.
- Under standard operating conditions, the time accuracy immediately after calibration is $\pm(0.002\%$ of setting + 450 ps).

Window OR Trigger [ENHANCED]

The instrument triggers on the OR logic of the ranges (window) of multiple trigger sources.

Example

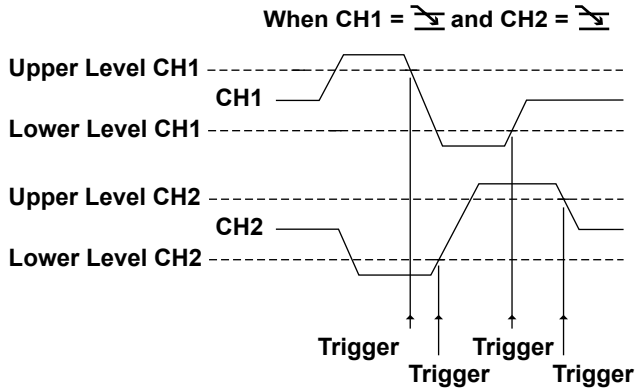

Required Condition (Pattern)



Set the trigger sources and trigger slopes.

Trigger Sources

Select the trigger sources from the following: CH1 to CH4 or All. (The selectable settings vary depending on the model.) If you select All, CH1 to CH4 become trigger sources.

Polarity

Select the polarity from the following.

	When the trigger source level enters the specified voltage span (window)
	When the trigger source level goes outside of the specified voltage span (window)

Trigger Levels (Levels)

Set the range, HF rejection, noise rejection, trigger position, trigger delay, and trigger hold-off.

Range (Upper Level/Lower Level)

Set the upper and lower levels of the range.

HF Rejection (HF Rejection), Noise Rejection (Noise Rejection)

Set these items for the trigger source.

These items are the same as those of the edge trigger.

▶ [See here.](#)

Trigger Position (POSITION), Trigger Delay (DELAY), Trigger Hold-Off (Holdoff)

These items are the same as those of the edge trigger.

▶ [See here.](#)

Interval Trigger [ENHANCED]

The instrument triggers when the relationship between the trigger source's period (i.e., the interval between edges) and the specified reference times meets the selected time condition. When the time condition is timeout, the instrument triggers when a timeout occurs.

Example

Source: CH1 \uparrow , Time Qualification: More than ($t > \text{Time}$)

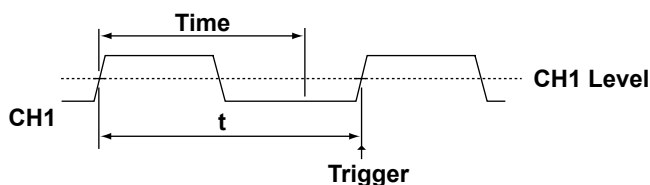

Trigger Source (Source)

Select the trigger source from the following: CH1 to CH4 or LOGIC. (The selectable settings vary depending on the model.) If you set the trigger source to LOGIC, set the source bit.

Trigger Slope (Slope)

For the signal assigned to be the trigger source, select which trigger slope to compare with the reference time.

\uparrow	When the trigger source changes from a level below the trigger level to a level above the trigger level (rising)
\downarrow	When the trigger source changes from a level above the trigger level to a level below the trigger level (falling)

Time Condition (Time Qualification)

Set what kind of relationship must be established between the trigger source's period and the specified reference times (Time, Time1, and Time2) for the instrument to trigger.

More than	The period must be longer than the specified reference time (Time).
Less than	The period must be shorter than the specified reference time (Time).
Inside	The period must be longer than reference time Time1 and shorter than reference time Time2.
Outside	The period must be shorter than reference time Time1 or longer than reference time Time2.
Timeout	The period must be longer than the reference time specified (Time).

Reference Times (Time or Time1 and Time2)

The selectable range for Time or Time1 and Time2 varies depending on the time condition.

More than	Time: 2 ns to 10 s
Less than	Time: 4 ns to 10 s
Inside	Time1: 2 ns to [10 s - 2 ns], Time2: 4 ns to 10 s
Outside	Time1: 2 ns to [10 s - 2 ns], Time2: 4 ns to 10 s
Timeout	Time1: 4 ns to 10 s

Resolution: 2 ns

Level (Level), HF Rejection (HF Rejection), Noise Rejection (Noise Rejection)

Set these items for each trigger source.

These items are the same as those of the edge trigger.

▶ [See here.](#)

Trigger Position (POSITION), Trigger Delay (DELAY), Trigger Hold-Off (Holdoff)

These items are the same as those of the edge trigger.

▶ [See here.](#)

4 Triggering



- The instrument may not trigger properly if the spacing between signals or the time detection width is less than 1 ns.
 - Under standard operating conditions, the time accuracy immediately after calibration is as follows:
CH1 to CH4: $\pm(0.002\% \text{ of setting} + 450 \text{ ps})$
LOGIC: $\pm(0.002\% \text{ of setting} + 1 \text{ ns})$
-

Serial Bus Trigger [ENHANCED]

The instrument has trigger features that capture the following ten types of serial bus signals. Of the ten types, FlexRay, CAN, CAN FD, LIN, CXPI, SENT, UART, I2C, and SPI bus triggers are options available only for 4-channel models.

FlexRay Bus Trigger

The FlexRay bus trigger is used to capture FlexRay bus signals. FlexRay is an automotive LAN communication protocol established by the FlexRay Consortium.

CAN Bus Trigger

The CAN bus trigger is used to capture CAN bus signals.

Controller Area Network (CAN) is a serial communication protocol that has been standardized internationally by the ISO (International Organization for Standardization). The instrument is equipped with a symbolic trigger function.*

* Using YOKOGAWA free software, you can convert a CANdb file (.dbc) to a physical value/symbol definition file, (.sbl), load the file into the instrument, and use it as a set of trigger conditions. You can obtain the free software from the YOKOGAWA website (<http://www.yokogawa.com/tm/>).

CANdb files (.dbc) are signal definition database files created using the CANdb or CANdb++ software produced by Vector Informatik.

CAN FD Bus Trigger

The CAN FD bus trigger is used to capture CAN FD bus signals.

CAN FD is an abbreviation for CAN with Flexible Data Rate. It is based on CAN and supports high-speed data-phase transfer rates. The length of data that can be embedded in a single Data Field is expanded to up to 64 bytes, and the CRC generator polynomial is also expanded. As with CAN, symbolic triggering is possible.

LIN bus trigger

The LIN bus trigger is used to capture LIN bus signals.

A Local Interconnect Network (LIN) is a serial communication protocol mainly used in automobiles.

CXPI Bus Trigger

The CXPI bus trigger is used to capture CXPI bus signals.

CXPI is an acronym for Clock Extension Peripheral Interface and is an on-vehicle LAN communication protocol used for human machine interface (HMI) and other interfaces of automotive electronic systems.

SENT Trigger

The SENT bus trigger is used to capture SENT signals.

SENT is an abbreviation for Single Edge Nibble Transmission. It is a point-to-point unidirectional serial communication protocol. The instrument supports SAE J2716 ARP2016 and earlier versions.

UART trigger

The UART trigger is used to capture UART signals.

A Universal Asynchronous Receiver Transmitter (UART) is an integrated circuit that performs serial-to-parallel conversion and parallel-to-serial conversion. UART signals are generally used in inter-device communication such as with EIA RS-232.

4 Triggering

I²C bus trigger

The I²C bus trigger is used to capture I²C bus signals.

An Inter Integrated Circuit (I²C) bus is a bi-directional bus for inter-IC communications.

SPI bus trigger

The SPI bus trigger is used to capture SPI bus signals.

A Serial Peripheral Interface (SPI) is a synchronous serial bus that is widely used for inter-IC communications and data communications.

User-Defined Trigger

The user-defined trigger is used to capture user-defined serial bus signals.

The instrument synchronizes to the selected clock signal and detects a serial data pattern. You can specify up to 128 bits for the serial data pattern used for triggering. You can set the CS signal, which controls the period over which the data source is checked, and the latch source, which specifies when patterns are compared.

Auto Setup

If you specify the serial bus type and the trigger source, the instrument can automatically configure the bit rate and source level settings and then trigger based on those settings. The auto setup feature will not work properly on some input signals. This feature is in the serial bus signal search feature.

FlexRay Bus Trigger [ENHANCED, option]

The instrument triggers based on the trigger conditions of a particular frame or type of data in a FlexRay bus signal.

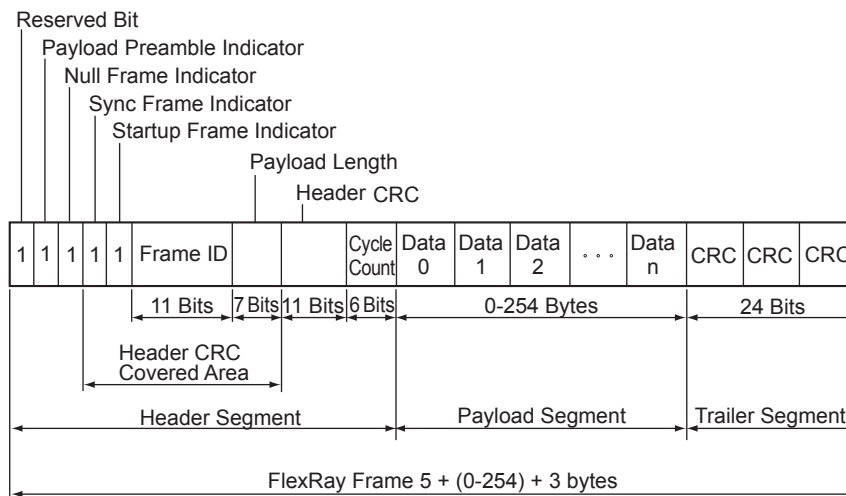

Trigger Mode (Mode)

Select the FlexRay trigger mode from one of the settings below.

Frame Start: Triggers on the start of a frame

Error: Triggers on errors

ID/Data: Triggers on the AND of the ID bit pattern and Data pattern

ID OR: Triggers on the OR of multiple ID bit patterns

Frame Start

The instrument triggers on the start of FlexRay bus signal frames.

Error

The instrument triggers when it detects various types of errors.

- **Error Type (Error Type Or)**

Select the types of errors to detect from the following. The instrument triggers if any of the selected errors is detected.

CRC	When a Header CRC or Frame CRC error is detected
BSS	When a BSS error is detected (there is no BSS falling edge at the specified position)
FES	When an FES error is detected (there is no FES rising edge at the specified position)

ID/Data

The instrument triggers on the AND of Frame Start, Indicator, ID, Cycle Count, Data1, and Data2.

- **Trigger Condition (Condition Setup)**

On the Condition Setup screen, set the Indicator, ID, Cycle Count, Data1, and Data2 trigger conditions.

Frame Start

The instrument triggers on the start of FlexRay bus signal frames. Frame Start of ID/Data is always selected as a trigger condition.

Indicator

You can use the states of four indicators as trigger conditions. The Indicator trigger condition is met when the input-signal Indicator bit pattern matches the specified bit pattern.

Bit Pattern (Indicator Setup)

Select the bit patterns of the four indicators from one of the following settings.

Payload Preamble	
X	Don't care.
0	There is no option header in the payload segment.
1	There is a network management vector in the payload segment (static segment). There is a message ID in the payload segment (dynamic segment).
Null Frame	
X	Don't care.
0	There is invalid data included in the payload segment.
1	There is valid data included in the payload segment.
Sync Frame	
X	Don't care.
0	The frame is not a sync frame.
1	The frame is a sync frame.
Startup Frame	
X	Don't care.
0	The frame is not a startup frame.
1	The frame is a startup frame.

4 Triggering

ID

You can use an 11-bit ID value as a trigger condition.

Comparison Condition (Condition)

The frame ID trigger condition is met when the relationship between the reference value and the input-signal ID value matches the specified comparison condition.

ID=a ¹	When the value is equal to the reference value
ID≠a ¹	When the value is not equal to the reference value
a≤ID ¹	When the value is greater than or equal to the reference value
ID≤b ¹	When the value is less than or equal to the reference value
a≤ID≤b ²	When the value is within the reference range (including the reference values)
ID<a, b<ID ²	When the value is outside the reference range (excluding the reference values)

1 Set one reference value

2 Set two reference values

Reference Values (a and b)

You can set the reference values within the range of 1 to 2047.

Cycle Count

You can use a 6-bit cycle-count value as a trigger condition.

Comparison Condition (Condition) and Reference Values (a and b)

The cycle-count trigger condition is met when the relationship between the reference values and the input-signal cycle-count value matches the specified comparison condition. The comparison conditions are the same as those listed for Frame ID. You can set the reference values within the range of 0 to 63.

Data1/Data2

You can use the value of up to 8 consecutive bytes of data from Data 0 to Data 253 as a trigger condition.

Data Length (Size)

Set how many consecutive data bytes of the payload segment will be compared.

Selectable range: 1 to 8 bytes

Comparison Start Position (Position)

Set the comparison start position. For example, to start from Data1 in the payload segment, set this value to 1.

Selectable range: 0 to 253 bytes

Comparison Condition (Condition)

The data trigger condition is met when the relationship between the reference values and the input-signal data value matches the specified comparison condition.

True	When the value matches the data pattern
False	When the value does not match the data pattern
Data=a ¹	When the value is equal to the reference value
Data≠a ¹	When the value is not equal to the reference value
a≤Data ¹	When the value is greater than or equal to the reference value
Data≤b ¹	When the value is less than or equal to the reference value
a≤Data≤b ²	When the value is within the reference range (including the reference values)
Data<a, b<Data ²	When the value is outside the reference range (excluding the reference values)

1 Set one reference value

2 Set two reference values

Data Pattern (Hex/Bin)

If the comparison condition is set to True or False, set the data pattern for the specified data size in hexadecimal (Hex) or binary (Bin) notation.

If you specify X in the pattern, the condition is assumed to be met regardless of the corresponding bit status.

If a binary pattern contains any Xs, the corresponding hexadecimal display will be "\$."

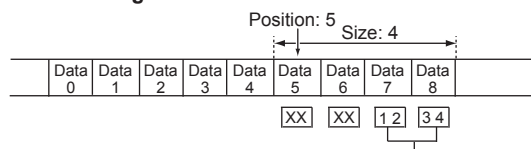
Example When the Comparison Start Position Is Set to 5 and the Data Length Is Set to 4

Example when out of the four bytes, the lower 2 bytes is set to 1234

Reference Values (a and b)

If the comparison condition is set to Data = A, Data ≠ a, a ≤ Data, Data ≤ b, a ≤ Data ≤ b, or "Data < a or b < Data," set the reference values in decimal notation. You must set the byte order (Endian), sign (Sign), and comparison range (MSB or LSB). The selectable ranges are as follows:

Unsigned (Unsign)	0 to 9E+18 The selectable maximum value is limited by the data length and bit position, which is determined by the Size and MSB/LSB settings, respectively.
Signed (Sign)	-9E+18 to 9E+18 The selectable minimum and maximum values are limited by the data length and bit position, which are determined by the Size and MSB/LSB settings, respectively.

The value is displayed in scientific notation when the number of digits exceed seven (example: 1234567E+10).

Byte Order (Endian)

Set the data byte order to big endian (Big) or little endian (Little).

Sign (Sign)

Set whether to use a signed (Sign) or unsigned (Unsign) data format.

The selectable range of data reference values varies depending on whether the data is signed or unsigned.

Comparison Range (MSB/LSB)

Set the MSB (MSB) or LSB (LSB) bit positions for the data that you will compare.

Selectable range: 0 to (the number of bytes of data × 8 - 1). The maximum value is 63.

▶ [See here.](#)

ID OR

The instrument triggers when ID or Cycle Count matches any of the patterns that you set in IDs 1 to 4.

Of ID1 to ID4, IDs whose check boxes are selected are used as trigger conditions. The instrument triggers when (1) the relationship between an ID reference value and the input-signal ID value matches the specified comparison condition and (2) the relationship between the cycle-count reference values and the input-signal cycle-count value matches the specified comparison condition.

The ID and cycle-count comparison conditions and reference values are the same as those for the ID/Data setting, except that for the cycle count, the comparison condition can be set to "Don't care" (so that the cycle count is not used as a trigger condition).

▶ [See here.](#)

4 Triggering

Source (Source)

Select the trigger source. After selecting the trigger source, configure the trigger level, hysteresis, bit rate, bus channel assignment, HF rejection, and other settings.

Trigger Level (Level)

You can set the FlexRay bus signal trigger level for each channel from CH1 to CH4.

Set the trigger level between the levels set for Idle and Data_0 so that the trigger circuit recognizes Data_1 and Idle as H and Data_0 as L.

- You can set the trigger level in 0.01 division steps to a value that fits within the 8 divisions of the screen. For example, when the voltage scale is 200 mV/division, you can set the trigger level in 2 mV steps.
- You can reset the trigger level to the current offset voltage by pressing RESET.

Hysteresis (Hysteresis)

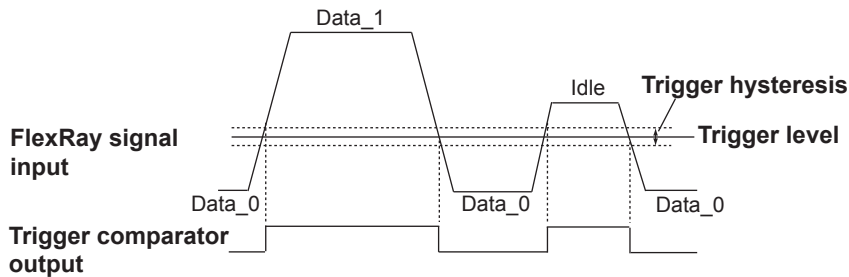

Bit Rate (Bit Rate)

Select the FlexRay bus signal's transfer rate from one of the settings below.

2.5 Mbps, 5 Mbps, 10 Mbps

Bus Channel Assignment (Channel)

Select whether to use channel A or B of the FlexRay bus signal.

HF Rejection (HF Rejection)

Set these items for the trigger source.

This item is the same as those of the edge trigger.

▶ [See here.](#)

Trigger Point

The trigger occurs near the BSS falling edge immediately after all the trigger conditions are met. The only exception is that the trigger occurs near the FES rising edge when the trigger mode is set to Error, there is no CRC error in the FlexRay bus signal header, and there is only a CRC error in the frame.

Frame Start mode

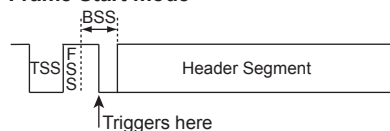

BSS: Byte Start Sequence
FES: Frame End Sequence

Error mode

- When there is a CRC error in the header
- When there is a CRC error in the frame

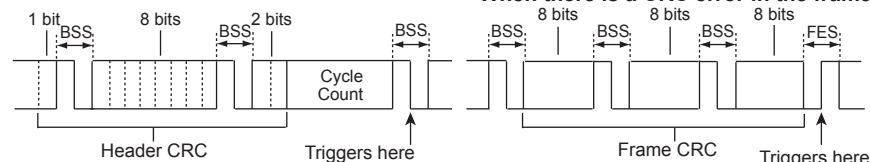

- When there is a BSS error

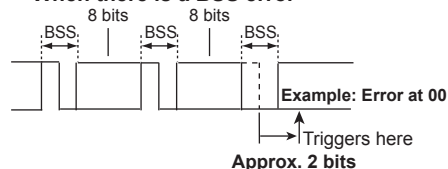

- When there is an FES error

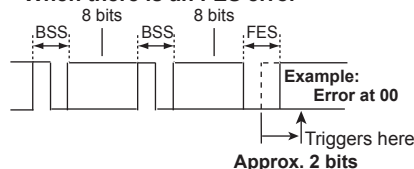

ID/Data mode

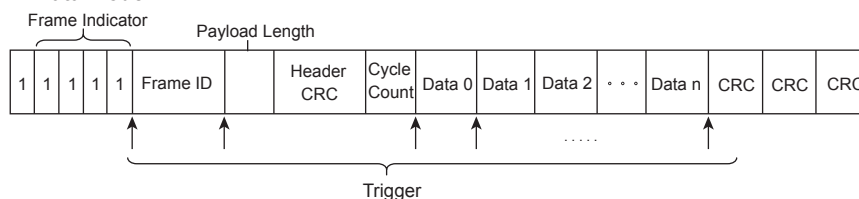

When the trigger mode is set to Error, the instrument uses its internal sampling clock for sampling, so jitter equal to one period of the sampling clock arises. One period of the sampling clock is a period of time equal to 1/8 of the bit width at the specified bit rate. For example, when the bit rate is 5 Mbps, the jitter is 25 ns.

Digitalization in the Trigger Circuit

After the input signal from the FlexRay bus is digitized by the trigger comparator, the trigger circuit samples it using the internal clock. Then noise is removed by the majority filter in the Voting Window.

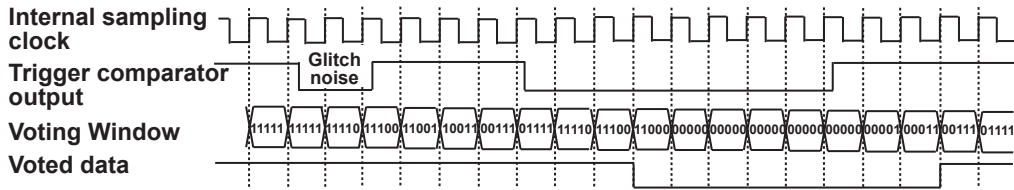

1 bit is equal to 8 sampling clock periods. The sampling counter is reset at the BSS falling edge of the voted data. The voted data value when the value of this sampling counter reaches 5 is used as the bit value for detecting the triggering conditions.

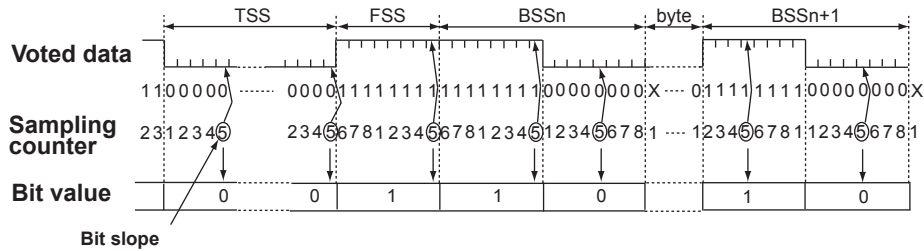

CAN Bus Trigger [ENHANCED, option]

The instrument triggers based on the trigger conditions of a particular frame or type of data in a CAN bus signal.

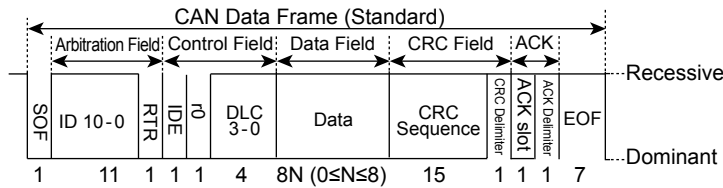

Trigger Mode (Mode)

Select the CAN bus trigger mode from one of the settings below.

SOF: Triggers on the start of a frame

Error: Triggers on errors

ID/Data: Triggers on the AND of the ID bit pattern and Data pattern

ID OR: Triggers on the OR of multiple ID bit patterns

SOF(Start of Frame)

The instrument triggers on the start of CAN bus signal frames.

Error

The instrument triggers on error frames (when the error flag is active) or when it detects various errors.

- Error Type (Error Type Or)**

Select the types of errors to detect from the following. The instrument triggers if any of the selected errors is detected.

Error Frame	When an active error flag (indicated by six consecutive dominant bits) is detected
Stuff	When stuff bits are not inserted properly
CRC	When a CRC error is detected

ID/Data

The instrument triggers based on data frames and remote frames in the standard format (Standard) and the extended format (Extend).

The instrument triggers on the AND of the SOF, ID, frame type (Remote Frame or Data Frame), Data, and ACK conditions.



- If you specify X in the ID bit pattern or data pattern, the condition is assumed to be met regardless of the corresponding bit status.
- In a bit pattern or data pattern setting, if a binary pattern contains any Xs, the corresponding hexadecimal display will be "\$."

- **Trigger Condition (Condition Setup)**

On the Condition Setup screen, set the trigger conditions such as the ID, frame type (Remote Frame or Data Frame) and data.

Frame Format

Select the frame format.

- Standard: Standard format
- Extend: Extended format

SOF

Triggers on the start of a CAN bus signal frame when the trigger condition is set to SOF only. SOF of ID/Data is always selected as a trigger condition.

ID**Input Format (Input format)**

Select the ID input format from one of the settings below.

- Pattern: Set the bit pattern of each ID in hexadecimal or binary notation.
- Message: Select this setting to set the ID or Data trigger conditions by using messages and signals that are defined in the symbol definition file (sbl).

Bit Pattern (Hex/Bin)

Set the 11-bit standard format ID bit pattern or the 29-bit extended format ID bit pattern in hexadecimal (Hex) or binary (Bin) notation. The ID trigger condition is met when the input signal ID bit pattern matches the specified bit pattern. You can only set these items when you set the trigger source frame to Pattern.

Remote Frame/Data Frame

Set the trigger source frame to Remote Frame or Data Frame.

Data

You can set a trigger condition based on the data field value. Specify the DLC, Condition, and data pattern settings. You can only set these items when you set the trigger source frame to Data Frame.

DLC(Data Length Code)

Set the data length of the data field. The DLC trigger condition is met when the specified value matches the input signal DLC value.

Selectable range: 0 to 8 bytes

4 Triggering

Comparison Condition (Condition)

The data trigger condition is met when the result of comparing the data pattern or reference value to the input signal's data field meets the specified comparison condition.

True	When the value matches the data pattern
False	When the value does not match the data pattern
Data=a ¹	When the value is equal to the reference value
Data≠a ¹	When the value is not equal to the reference value
a≤Data ¹	When the value is greater than or equal to the reference value
Data≤b ¹	When the value is less than or equal to the reference value
a≤Data≤b ²	When the value is within the reference range (including the reference values)
Data<a, b<Data ²	When the value is outside the reference range (excluding the reference values)

1 Set one reference value

2 Set two reference values

Data Pattern (Hex/Bin)

If the comparison condition is set to True or False, set the data pattern for the data whose length was set with DLC in hexadecimal (Hex) or binary (Bin) notation.

Reference Values (a and b)

If the comparison condition is set to Data = A, Data ≠ a, a ≤ Data, Data ≤ b, a ≤ Data ≤ b, or "Data < a or b < Data," set the reference values in decimal notation. You must set the byte order (Endian), sign (Sign), and comparison range (MSB or LSB). The selectable ranges are as follows:

Unsigned (Unsign)	0 to 9E+18 The selectable maximum value is limited by the data length and bit position, which are determined by the DLC and MSB/LSB settings, respectively.
Signed (Sign)	-9E+18 to 9E+18 The selectable minimum and maximum values are limited by the data length and bit position, which are determined by the DLC and MSB/LSB settings, respectively.

The value is displayed in scientific notation when the number of digits exceed seven (example: 1234567E+ 10).



If the comparison condition is a ≤ Data ≤ b or "Data < a or b < Data," the two reference values are automatically adjusted so that the lower limit is less than or equal to the upper limit.

Byte Order (Endian)

Set the byte order of the data stream to Big Endian (Big) or Little Endian (Little). The following figure illustrates a 4-byte data stream on the bus. The data field value is 12345678 in hexadecimal notation.

Big endian

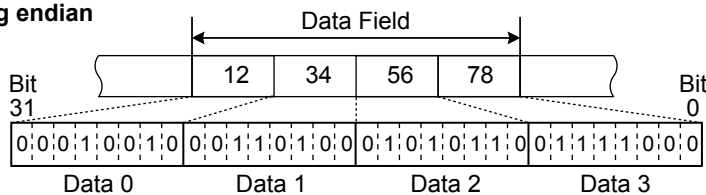

Little endian

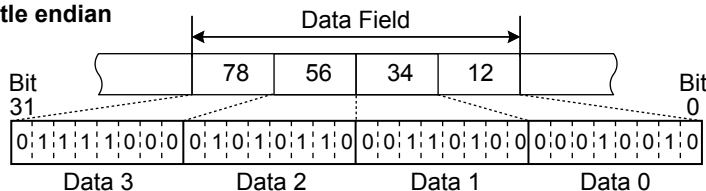

Sign (Sign)

Set whether to use a signed (Sign) or unsigned (Unsign) data format.

The selectable range of data reference values varies depending on whether the data is signed or unsigned.

Comparison Range (MSB/LSB)

Set the MSB (MSB) or LSB (LSB) bit positions for the data that you will compare. For example, if you want to compare bits 5 through 20 of a 4-byte data value (12345678: hexadecimal), set the MSB to 20 and the LSB to 5. In this case, the bits that are compared are those that are shaded in the following figure.

Selectable range: 0 to (the number of bytes of data × 8 – 1). The maximum value is 63.

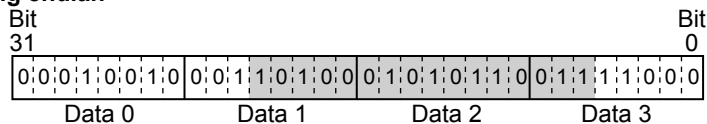
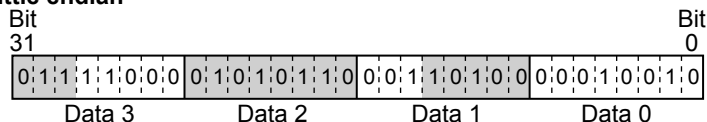
Big endian**Little endian****ACK Mode**

You can set a trigger condition based on the ACK slot state. The ACK trigger condition is met when the specified state matches the input signal ACK slot state.

NON ACK	When the status is recessive
ACK	When the status is dominant
NON or ACK	When the status is recessive or dominant

Message/Signal

The messages and symbols in the physical value/symbol definition file (.sbl) that has been loaded into the instrument can be used to set the trigger condition.* Messages and signals can be used when the ID input format is set to Message.

* Physical value/symbol definition files (.sbl) are derived by converting CANdb files (.dbc).

Message

Select the ID from the Message list in the sbl file that has been loaded. The message trigger condition is met when the selected message matches the input signal ID.

Signal

Select the data from the Signal list in the sbl file that has been loaded. The signal trigger condition is met when the selected signal matches the input signal data.

Comparison Condition (Condition) and Reference Values (a and b)

The signal trigger condition is met when the result of comparing the reference values to the input signal data meets the specified comparison condition.

The method of setting the comparison condition and reference values (a and b) is the same as with the ID/Data mode when the input format is set to Pattern. However, you cannot set the comparison condition to True or False.



The values loaded from the sbl file are used for the Endian, Sign, MSB/LSB, and ACK items.

4 Triggering

ID OR

The instrument triggers based on data frames and remote frames in the standard format (Standard) and the extended format (Extend).

The instrument triggers on the AND of the SOF, multiple IDs, frame type (Remote Frame or Data Frame), and ACK conditions.

The ID trigger condition is met when the ID matches any of the patterns that you set in ID1 to ID4.

- **Trigger Condition (Condition Setup)**

On the Condition Setup screen, set the ID, ACK, and other trigger conditions.

Frame Format

Select the frame format. This setting applies to ID1 to ID4.

- Standard: Standard format
- Extend: Extended format

SOF

Triggers on the start of a CAN bus signal frame when the trigger condition is set to SOF only. SOF of ID OR is always selected as a trigger condition.

ID Input Format (ID Input format)

Select the ID input format from one of the settings below.

- Pattern: Set the bit pattern of each ID in hexadecimal or binary notation.
- Message: Select this setting to set the ID trigger conditions by using messages that are defined in the symbol definition file (.sbl).

ID1 to ID4

You can set up to four IDs. IDs whose check boxes are selected are used as trigger conditions.

The ID trigger condition is met when the input signal ID bit pattern matches any of the specified ID bit patterns. The method for setting the bit pattern of each ID is the same as with the ID/Data setting.

▶ [See here.](#)

Remote Frame/Data Frame

Set the trigger source frame to Remote Frame or Data Frame.

ACK Mode

You can set a trigger condition based on the ACK slot state. The ACK trigger condition is met when the specified state matches the input signal ACK slot state.

NON ACK	When the status is recessive
ACK	When the status is dominant
NON ACK or ACK	When the status is recessive or dominant

Message

The messages in the physical value/symbol definition file (.sbl) that has been loaded into the instrument can be used to set the trigger condition. Messages can be used when the ID input format is set to Message. The method for setting the message is the same as with the ID/Data setting.

▶ [See here.](#)

Source (Source)

Select the trigger source. After selecting the trigger source, configure the trigger level, hysteresis, bit rate, recessive level, HF rejection, sample point, and other settings.

Source (Source)

Set the trigger source to one of the settings below.

CH1 to CH4

Bit Rate (Bit Rate)

Select the CAN bus signal's transfer rate from one of the settings below.

33.3 kbps, 83.3 kbps, 125 kbps, 250 kbps, 500 kbps, 1 Mbps, User Define

If you select User Define, set the transfer rate in the range of 10 kbps to 1 Mbps in 0.1-kbps steps.

Recessive Level (Recessive)

Select the recessive level from one of the settings below. In either setting, the logical value of the recessive level is 1, and the logical value of the dominant level is 0.

H	The recessive level is greater than the dominant level.
L	The recessive level is less than the dominant level.

Sample Point (Sample Point)

You can set the reference that will be used to determine the bus level (recessive or dominant) in the range of 18.8 to 90.6% in 3.1% steps.

The instrument's CAN bus signal trigger circuit samples the input CAN bus signal using the internal clock and detects the point of change from recessive to dominant. Set the sample point as a percentage, with the detected point of change equal to 0% and the point that is bit time after the point of change equal to 100%. The bit time is the inverse of the set bit rate.

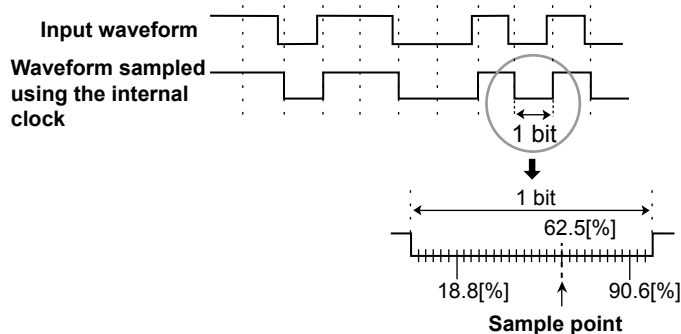
If the sample point is set to 62.5%**Level (Level), HF Rejection (HF Rejection)**

Set these items for the trigger source.

These items are the same as those of the edge trigger.

▶ [See here.](#)

Hysteresis (Hysteresis)

You can apply a hysteresis to the detection level so that level changes within the range will not be detected as edges.

Selectable range: 0.3 div to 8.0 div

Resolution: 0.1 div

Frame Format and Trigger Point

The following figures illustrate the formats and trigger points of the various frames.

Data Frame (Data Frame)

- Standard format

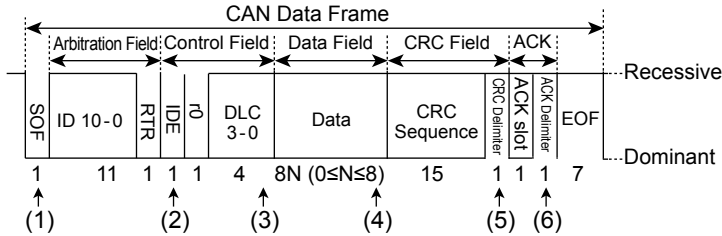

- Extended format

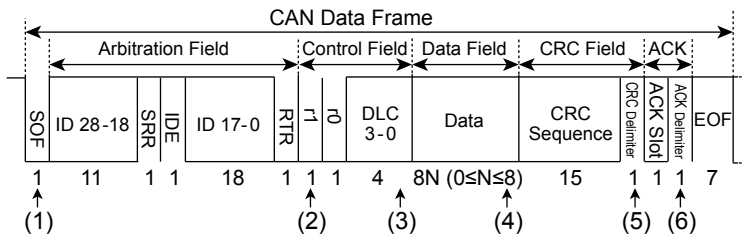

Positions (1) to (6) above are trigger points for the following conditions.

- (1) SOF
- (2) ID
- (3) Data Frame (when DLC = 0)
- (4) Data Frame (when DLC ≠ 0)
- (5) CRC Error
- (6) ACK

Remote Frame (Remote Frame)

- Standard format

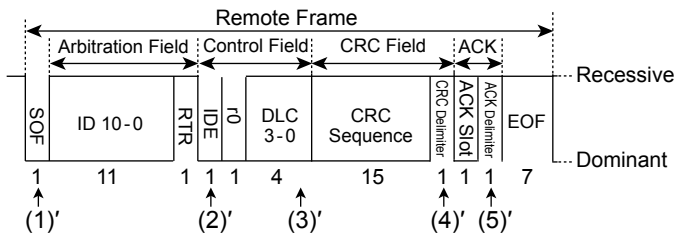

- Extended format

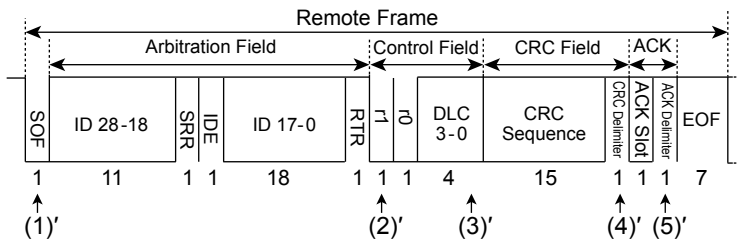

Positions (1)' and (5)' above are trigger points for the following conditions.

- (1)' SOF
- (2)' ID
- (3)' Remote Frame (when DLC = 0)
- (4)' CRC Error
- (5)' ACK

Error Frame

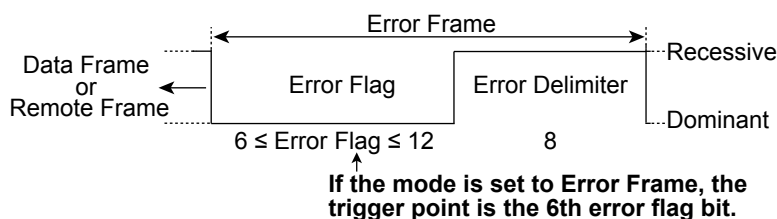

Stuff Error (Stuff Error)

The trigger point is the sample point of the bit that violates the bit stuffing rule.

CRCError (CRC Error)

CRC errors are indicated in the data-frame and remote-frame figures.



If multiple field types and frame types are combined, the trigger point is the point where the last type appears on the time axis.

High speed CAN (ISO11898) and Low speed CAN (ISO11519-2)

The primary standards for the CAN physical layer are High-speed CAN (ISO11898) and Low-speed CAN (ISO11519-2).

As shown in the following figure, the bus level is determined by the potential difference between two buses, CAN_High and CAN_Low, in either standard.

High speed CAN (ISO11898)

Transfer rate: 1 Mbps or less

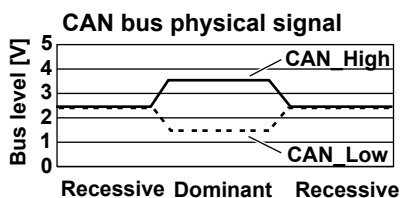
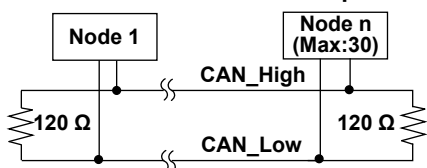

Low speed CAN (ISO11519-2)

Transfer rate: 125 kbps or less

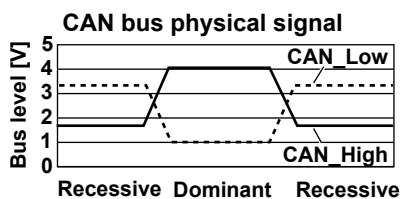
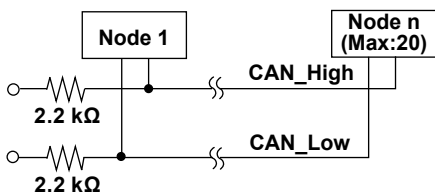

CAN FD Bus Trigger [ENHANCED, option]

The instrument triggers based on the trigger conditions of a particular frame or type of data in a CAN FD bus signal (ISO 11898-1: 2015 or non-ISO).

CAN FD (ISO 11898-1: 2015)

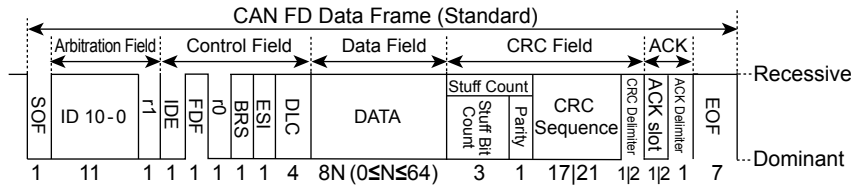

CAN FD (non-ISO)

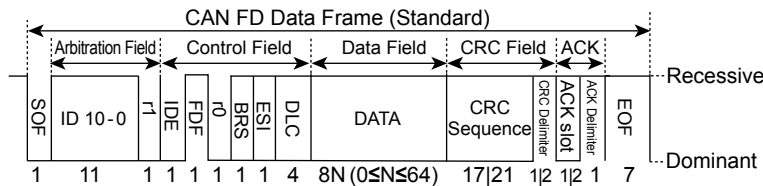

Trigger Mode (Mode)

Select the CAN FD bus trigger mode from one of the settings below.

SOF: Triggers on the start of a frame

Error: Triggers on errors

ID/Data: Triggers on the AND of the ID bit pattern and Data pattern

ID OR: Triggers on the OR of multiple ID bit patterns

FDF: Triggers on the FDF bit state

ESI (ErrorPassive): Triggers when the ESI bit is recessive (error passive)

SOF(Start of Frame)

The instrument triggers on the start of CAN FD bus signal frames.

Error

The instrument triggers on an error (when the error flag is active) or when it detects various errors.

- CAN FD Standard (FD Standard)**

Select the compliant standard for the CAN FD bus signal to be applied.

ISO:ISO 11898-1: Captured as a 2015-compliant CAN FD bus signal.

non-ISO:ISO 11898-1: Captured as a CAN FD bus signal compliant to a standard before 2015.

- Error Type (Error Type Or)**

Select the types of errors to detect from the following. The instrument triggers if any of the selected errors is detected.

Error Frame	When an active error flag (indicated by six consecutive dominant bits) is detected
Stuff	When stuff bits are not inserted properly
Fixed Stuff	When fixed CRC stuff bits are not inserted properly
CRC	When a CRC error is detected If the aforementioned CAN FD standard is set to ISO, select the CRC error factor from one of the settings below. You can also select both. Stuff Count, CRC Sequence

ID/Data

The instrument triggers based on data frames and remote frames in the standard format (Standard) and the extended format (Extend).

The instrument triggers on the AND of the SOF, ID, frame type (Remote Frame or Data Frame), Data, and ACK conditions.



- If you specify X in the ID bit pattern or data pattern, the condition is assumed to be met regardless of the corresponding bit status.
- In a bit pattern or data pattern setting, if a binary pattern contains any Xs, the corresponding hexadecimal display will be "\$."

- **Trigger Condition (Condition Setup)**

On the Condition Setup screen, set the trigger conditions such as the ID, frame type (Remote Frame or Data Frame) and data.

Frame Format

Select the frame format.

- Standard: Standard format
- Extend: Extended format

SOF

Triggers on the start of a CAN FD bus signal frame when the trigger condition is set to SOF only. SOF of ID/Data is always selected as a trigger condition.

ID**Input Format (Input format)**

Select the ID input format from one of the settings below.

- Pattern: Set the bit pattern of each ID in hexadecimal or binary notation.
- Message: Select this setting to set the ID or Data trigger conditions by using messages and signals that are defined in the symbol definition file (sbl).

Bit Pattern (Hex/Bin)

Set the 11-bit standard format ID bit pattern or the 29-bit extended format ID bit pattern in hexadecimal (Hex) or binary (Bin) notation. The ID trigger condition is met when the input signal ID bit pattern matches the specified bit pattern. You can only set these items when you set the trigger source frame to Pattern.

Remote Frame/Data Frame

Set the trigger source frame to Remote Frame or Data Frame.

Data

You can set a trigger condition based on the data field value. Specify the size, position, condition, and data pattern settings. You can only set these items when you set the trigger source frame to Data Frame.

Comparison Size (Size)

Set the data length to be compared. The data pattern with the specified data length is compared to the input signal data pattern. If "0" is specified, the instrument triggers regardless of the input signal's data field value.

Selectable range: 0 to 8 bytes

Comparison Start Position (Position)

Set the position to start comparing the data pattern. The left end of the data field is position 0.

Selectable range: 0 to 63 bytes

4 Triggering



- If the comparison size (Size) is set to 0, comparison start position (Position) cannot be set.
 - The selectable range for position is limited so that Size + Position is less than or equal to 64.
-

Comparison Condition (Condition)

The data trigger condition is met when the result of comparing the data pattern or reference value to the input signal's data field meets the specified comparison condition.

True	When the value matches the data pattern
False	When the value does not match the data pattern
Data=a ¹	When the value is equal to the reference value
Data≠a ¹	When the value is not equal to the reference value
a≤Data ¹	When the value is greater than or equal to the reference value
Data≤b ¹	When the value is less than or equal to the reference value
a≤Data≤b ²	When the value is within the reference range (including the reference values)
Data<a, b<Data ²	When the value is outside the reference range (excluding the reference values)

1 Set one reference value

2 Set two reference values

Data Pattern (Hex/Bin)

If the comparison condition is set to True or False, set the data pattern for the specified data size in hexadecimal (Hex) or binary (Bin) notation.

Reference Values (a and b)

If the comparison condition is set to Data = A, Data ≠ a, a ≤ Data, Data ≤ b, a ≤ Data ≤ b, or "Data < a or b < Data," set the reference values in decimal notation. You must set the byte order (Endian), sign (Sign), and comparison range (MSB or LSB).

The selectable ranges are as follows:

Unsigned (Unsign)	0 to 9E+18 The selectable maximum value is limited by the data length and bit position, which are determined by the Size and MSB/LSB settings, respectively.
Signed (Sign)	-9E+18 to 9E+18 The selectable minimum and maximum values are limited by the data length and bit position, which are determined by the Size and MSB/LSB settings, respectively.

The value is displayed in scientific notation when the number of digits exceed seven (example: 1234567E+10).



If the comparison condition is a ≤ Data ≤ b or "Data < a or b < Data," the two reference values are automatically adjusted so that the lower limit is less than or equal to the upper limit.

Byte Order (Endian), Sign (Sign), and Comparison Range (MSB/LSB)

These items are the same as those of the CAN bus trigger.

▶ [See here.](#)

ACK Mode

This item is the same as that of the CAN bus trigger.

▶ [See here.](#)

Message/Signal

This item is the same as that of the CAN bus trigger.

▶ [See here.](#)

ID OR

This item is the same as that of the CAN bus trigger.

▶ [See here.](#)

FDF

Set the FDF bit state as a trigger condition.

0 (CAN): When the FDF bit is dominant, the instrument assumes that the frame is a CAN bus signal frame and triggers.

1 (CAN FD): When the FDF bit is recessive, the instrument assumes that the frame is a CAN FD bus signal frame and triggers.

ESI(ErrorPassive)

The instrument triggers when the ESI bit is recessive (error passive).

Source (Source)

Select the trigger source. After selecting the trigger source, configure the trigger level, hysteresis, bit rate, recessive level, HF rejection, and sample point.

Source (Source)

Set the trigger source to one of the settings below.

CH1 to CH4

Bit Rate (Bit Rate)

Select the CAN FD bus signal's arbitration phase data transfer rate from one of the settings below.

250kbps, 500kbps, 1Mbps, User Define

If you select User Define, set the transfer rate in the range of 20 kbps to 1 Mbps in 0.1-kbps steps.

Sample Point (Sample Point)

You can set the reference that will be used to determine the bus level (recessive or dominant) of the CAN FD bus signal's arbitration phase in the range of 18.8 to 90.6% in 0.1% steps. The idea of sample point is the same as CAN bus signals.

▶ [See here.](#)

Data Bit Rate (Data Bit Rate)

Select the CAN FD bus signal's data phase data transfer rate from one of the settings below.

500kbps, 1Mbps, 2Mbps, 4Mbps, 5Mbps, 8Mbps, User Define

If you select User Define, set the transfer rate in the range of 250 kbps to 10 Mbps in 0.1-kbps steps.

The data bit rate can be set as high as 16 times the arbitration phase bit rate.

Sample Point of the Data Phase (Sample Point)

You can set the reference that will be used to determine the bus level (recessive or dominant) of the CAN FD bus signal's data phase in the range of 18.8 to 90.6% in 0.1% steps. The idea of sample point is the same as CAN bus signals.

▶ [See here.](#)



If the data bit rate exceeds 16 times the bit rate, the rates are automatically adjusted according to the last set value so that the relationship "data bit rate \leq bit \times 16" is maintained.

4 Triggering

Recessive Level (Recessive)

This item is the same as that of the CAN bus trigger.

▶ [See here.](#)

Level (Level), HF Rejection (HF Rejection)

Set these items for the trigger source.

These items are the same as those of the edge trigger.

▶ [See here.](#)

Hysteresis (Hysteresis)

This item is the same as that of the CAN bus trigger.

▶ [See here.](#)

Frame Format and Trigger Point

The following figures illustrate the formats and trigger points of the various frames.

Data Frame (Data Frame)

• Standard format

CAN FD (ISO 11898-1: 2015)

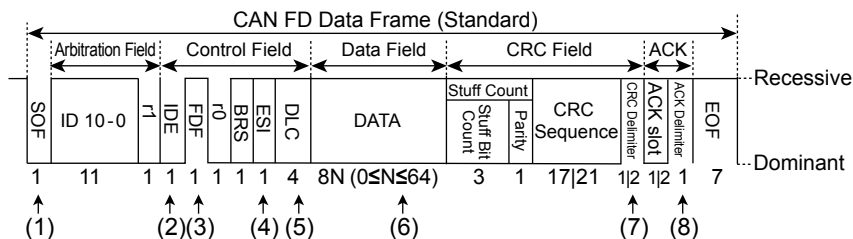

CAN FD (non-ISO)

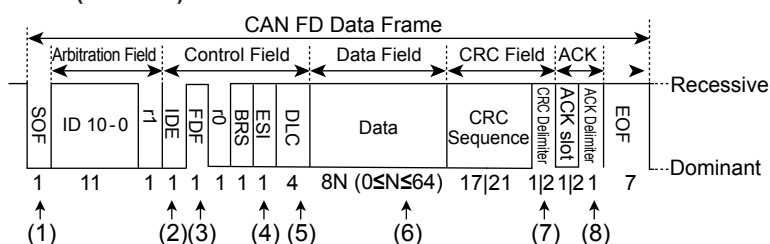

• Extended format

CAN FD (ISO 11898-1: 2015)

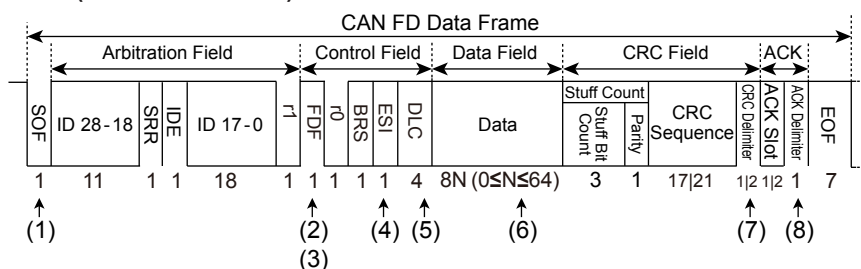

CAN FD (non-ISO)

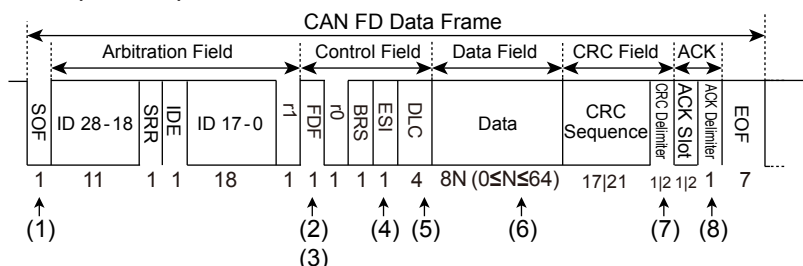

Positions (1) to (8) above are trigger points for the following conditions.

- | | |
|---------|---|
| (1) SOF | (5) Data Frame (when Size = 0) |
| (2) ID | (6) Data Frame (when Size ≠ 0) ¹ |
| (3) FDF | (7) CRC Error ² |
| (4) ESI | (8) ACK ³ |

1 Where the data patterns match.

2 If the CAN FD standard (FD Standard) is set to ISO, the detected point for both stuff count and CRC sequence errors are at the CRC Delimiter position.

3 If both CRC Delimiter and ACK Slot are 2 bits long, the trigger point is the second bit of ACK Slot. The detected point when you use the search feature of the instrument is the ACK Delimiter position regardless of the CRC Delimiter or ACK Slot condition.

4 Triggering

Remote Frame (Remote Frame)

This is the same as the CAN bus trigger.

▶ [See here.](#)

Error Frame (Error Frame)

This is the same as the CAN bus trigger.

▶ [See here.](#)

Stuff Error (Stuff Error, Fixed Stuff)

The trigger point is the sample point of the bit that violates the bit stuffing rule.

CRC Error (CRC Error)

CRC errors are indicated in the data-frame and remote-frame figures.



If multiple field types and frame types are combined, the trigger point is the point where the last type appears on the time axis.

LIN Bus Trigger [ENHANCED, option]

The instrument triggers based on the conditions of a particular field or type of data in a LIN bus signal. The following figure shows the LIN bus signal frame format.

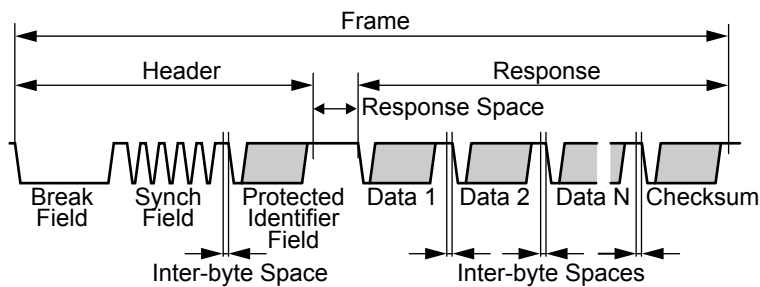

Trigger Mode (Mode)

Select the LIN bus trigger mode from one of the settings below.

Break Synch: Triggers on a break field or synch field

Error: Triggers on errors

ID/Data: Triggers on the AND of the ID bit pattern and Data pattern

ID OR: Triggers on the OR of multiple ID bit patterns

Break Synch

The instrument triggers when it detects a break field and then a synch field (Break Field + Synch Field).

- **Break Length**

Select the low-pulse bit length that is used to detect breaks from one of the options below.

10 or longer, 11 or longer, 12 or longer, or 13 or longer



If the instrument detects a break field and then a synch field (Break Field + Synch Field) in the middle of a LIN bus frame, it discards the frame and triggers the next time it detects a protected identifier field.

Error

The instrument triggers when it detects various types of errors.

- **Error Type (Error Type Or)**

Select the types of errors to detect from the following. The instrument triggers if any of the selected errors is detected.

Parity	<p>The instrument calculates the parity of the protected identifier field. If the result does not satisfy the following equations, the instrument triggers on the protected identifier field's stop bit position.</p> <p>Even Parity Check: $ID0 \text{ xor } ID1 \text{ xor } ID2 \text{ xor } ID4 \text{ xor } P0 = 0$ $P0 = ID0 \text{ xor } ID1 \text{ xor } ID2 \text{ xor } ID4$</p> <p>ODD Parity Check: $ID1 \text{ xor } ID3 \text{ xor } ID4 \text{ xor } ID5 \text{ xor } P1 = 1$ $P1 = \neg(ID1 \text{ xor } ID3 \text{ xor } ID4 \text{ xor } ID5)$</p>
Sync	<p>If the synch field is not 0x55, the instrument triggers on the synch field's stop bit position.</p>

ID/Data

The instrument triggers on the AND of ID and Data conditions.



- If you specify X in the ID bit pattern or data pattern, the condition is assumed to be met regardless of the corresponding bit status.
- In a bit pattern or data pattern setting, if a binary pattern contains any Xs, the corresponding hexadecimal display will be "\$."

- **Trigger Condition (Condition Setup)**

On the Condition Setup screen, set the ID, data, and other trigger conditions.

Break Synch

Triggers on a synch field that comes after a break field when the trigger condition is set to Break Synch only. Break Synch of ID/Data is always selected as a trigger condition.

ID

Set the bit pattern for the 6-bit protection ID (ID0 to ID5) in the protected identifier field in hexadecimal or binary notation. The ID trigger condition is met when the input signal ID bit pattern matches the specified bit pattern.

- Hex: Select this setting to set the ID bit pattern in hexadecimal notation.
- Bin: Select this setting to set the ID bit pattern in binary notation.

4 Triggering

Data Frame

You can specify a value from Data 1 to Data 8 as a trigger condition.

Data Length (Size)

Set how many consecutive data bytes will be compared.

Selectable range: 1 to 8 bytes

Comparison Condition (Condition)

The data trigger condition is met when the relationship between the data pattern or the reference value and the input signal data value matches the specified comparison condition.

True	When the value matches the data pattern
False	When the value does not match the data pattern
Data=a ¹	When the value is equal to the reference value
Data≠a ¹	When the value is not equal to the reference value
a≤Data ¹	When the value is greater than or equal to the reference value
Data≤b ¹	When the value is less than or equal to the reference value
a≤Data≤b ²	When the value is within the reference range (including the reference values)
Data<a, b<Data ²	When the value is outside the reference range (excluding the reference values)

1 Set one reference value

2 Set two reference values

Data Pattern (Hex/Bin)

If the comparison condition is set to True or False, set the data pattern for the specified data size in hexadecimal (Hex) or binary (Bin) notation.

Reference Values (a and b)

If the comparison condition is set to Data = A, Data ≠ a, a ≤ Data, Data ≤ b, a ≤ Data ≤ b, or “Data < a or b < Data,” set the reference values in decimal notation. You must set the byte order (Endian), sign (Sign), and comparison range (MSB or LSB). The selectable ranges are as follows:

Unsigned (Unsign)	0 to 9E+18 The selectable maximum value is limited by the data length and bit position, which are determined by the Data Size and MSB/ LSB settings, respectively.
Signed (Sign)	-9E+18 to 9E+18 The selectable minimum and maximum values are limited by the data length and bit position, which are determined by the Data Size and MSB/ LSB settings, respectively.

The value is displayed in scientific notation when the number of digits exceed seven (example: 1234567E+10).



If the comparison condition is a ≤ Data ≤ b or “Data < a or b < Data,” the two reference values are automatically adjusted so that the lower limit is less than or equal to the upper limit.

Byte Order (Endian)

Set the data byte order to big endian (Big) or little endian (Little).

Sign (Sign)

Set whether to use a signed (Sign) or unsigned (Unsign) data format.

The selectable range of data reference values varies depending on whether the data is signed or unsigned.

Comparison Range (MSB/LSB)

Set the MSB (MSB) or LSB (LSB) bit positions for the data that you will compare.

Selectable range: 0 to (the number of bytes of data × 8 – 1). The maximum value is 63.

▶ [See here.](#)

ID OR

The instrument triggers when the ID matches any of the patterns that you set in ID1 to ID4.

- **Trigger Condition (Condition Setup)**

On the Condition Setup screen, set the ID trigger conditions.

Break Synch

Triggers on a synch field that comes after a break field when the trigger condition is set to Break Synch only. Break Synch of ID OR is always selected as a trigger condition.

ID

ID1 to ID4

IDs whose check boxes are selected are used as trigger conditions.

The ID trigger condition is met when the input signal ID bit pattern matches any of the specified ID bit patterns. The method for setting the bit pattern of each ID is the same as with the ID/Data setting.

▶ [See here.](#)

Source (Source)

Select the trigger source. After selecting the trigger source, configure the bit rate, sample point, HF rejection, trigger level, hysteresis, and other settings.

Source (Source)

Set the trigger source to one of the settings below.

CH1 to CH4

Bit Rate (Bit Rate)

Select the LIN bus signal's transfer rate from one of the settings below.

1200 bps, 2400 bps, 4800 bps, 9600 bps, 19200 bps, User Define

If you select User Define, set the transfer rate in the range of 1000 bps to 20000 bps in 10-bps steps.

Sample Point (Sample Point)

You can set the reference that will be used to determine the bus level in the range of 18.8 to 90.6% in 3.1% steps.

The instrument's LIN bus signal trigger circuit samples the input LIN bus signal using the internal clock and detects the point of level change. Set the sample point as a percentage, with the detected point of change equal to 0% and the point that is bit time after the point of change equal to 100%. The bit time is the inverse of the set bit rate.

▶ [See here.](#)

Level (Level), HF Rejection (HF Rejection)

Set these items for the trigger source.

These items are the same as those of the edge trigger.

▶ [See here.](#)

Hysteresis (Hysteresis)

This item is the same as that of the CAN bus trigger.

▶ [See here.](#)

Trigger Point

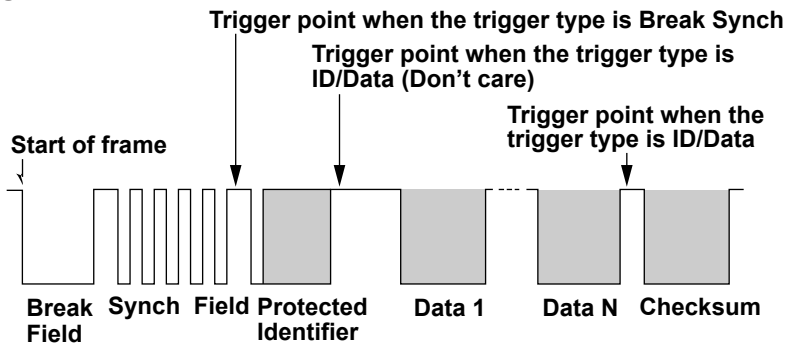

CXPI Bus Trigger [ENHANCED, option]

The trigger function uses the start of a CXPI bus signal frame or the combination of the start of a frame and the bit pattern (PID or PTYPE field) at the start of the frame. The following figure shows the CXPI bus signal frames.

Normal Frame

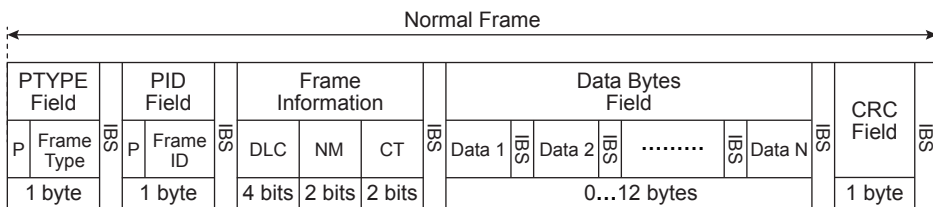

Long Frame

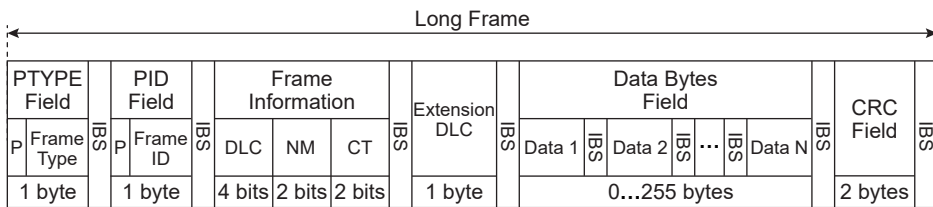

PTYPE at the start of each frame is an option for the polling method.

When the option is not used, the start of the frame is a PID. Refer to this figure along with the figures in "Trigger Point."

Trigger Mode (Mode)

Select the CXPI bus trigger mode from one of the settings below.

SOF: Triggers on the start of a frame

Error: Triggers on errors

PTYPE: Triggers on PTYPE

ID/Data: Triggers on the position where the AND condition of the ID bit pattern, frame information, and data pattern is met

ID OR: Triggers on the OR of multiple ID bit patterns

Wakeup/Sleep: Triggers on wakeup pulses, wakeup states, sleep frames, and sleep states

SOF(Start of Frame)

The instrument triggers on the start of CXPI bus signal frames.

Triggers can be activated on SOF alone.

* The start of a frame is found by detecting a logic 0 following 20 or more consecutive bits of logic 1's.

Error

The instrument triggers when it detects various types of errors.

- **Error Type (Error Type Or)**

Select the types of errors to detect from the following. The instrument triggers if any of the selected errors is detected.

Parity	When a parity error is detected
CRC	When a CRC error is detected
Data Length	When the DLC value and the number of data pieces in the data field (data length) do not match
Framing	When the logical value of the stop bit of a field or the stop bit of data is 0
IBS	When the number of IBS bits is 10 or more
Clock	When the clock width exceeds the specified tolerance

PTYPE

The instrument triggers on PTYPE.

Every PTYPE: The instrument triggers on every PTYPE.

No Response: The instrument triggers when a PID is not detected after PTYPE.

ID/Data

The instrument triggers on the AND of SOF, ID, frame information, and data.



- If you specify X in the ID bit pattern, frame information, or data pattern, the condition is assumed to be met regardless of the corresponding bit or item status.
- In a bit pattern or data pattern setting, if a binary pattern contains any Xs, the corresponding hexadecimal display will be "\$."

- **SOF**

The instrument triggers on the start of a CXPI bus signal frame when the trigger condition is set to SOF only. SOF of ID/Data is always selected as a trigger condition.

- **ID**

- **with PTYPE**

The instrument triggers on whether a frame contains PTYPE.

- Yes: Triggers on the ID of a frame containing PTYPE
- No: Triggers on the ID of a frame not containing PTYPE
- X: Triggers on the ID regardless of the presence of PTYPE

- **Bit Pattern (Hex/Bin)**

Set the 7-bit ID bit pattern in hexadecimal (Hex) or binary (Bin) notation. The instrument triggers when the specified bit pattern matches the input signal's ID bit.

- **Frame Information**

The instrument triggers on the wakeup and sleep indicators of frame information and CT bit value.

- Wakeup: Set the wakeup indicator bit value to 0, 1, or X.
- Sleep: Set the sleep indicator bit value to 0, 1, or X.
- CT: Set the counter bit value to a value from 0 to 3 or X.

4 Triggering

- **Data**

The instrument triggers by detecting a data value. Specify the size, position, and condition.

Comparison Size (Size)

Set the data length to be compared. The data pattern with the specified data length is compared to the input signal data pattern. If "0" is specified, the instrument assumes that a point has been detected regardless of the input signal's data value.

Selectable range: 0 to 8 bytes

Comparison Start Position (Position)

Set the data pattern start point. The left end of the data is position 0.

Selectable range: 0 to 254 bytes



- If the comparison size (Size) is set to 0, comparison start position (Position) cannot be set.
 - The selectable range for position is limited so that Size + Position is less than or equal to 255.
-

Comparison Condition (Condition)

The data trigger condition is met when the relationship between the data pattern or the reference value and the input signal data value matches the specified comparison condition.

True	When the value matches the data pattern
False	When the value does not match the data pattern
Data=a ¹	When the value is equal to the reference value
Data≠a ¹	When the value is not equal to the reference value
a≤Data ¹	When the value is greater than or equal to the reference value
Data≤b ¹	When the value is less than or equal to the reference value
a≤Data≤b ²	When the value is within the reference range (including the reference values)
Data<a, b<Data ²	When the value is outside the reference range (excluding the reference values)

1 Set one reference value

2 Set two reference values

Data Pattern

If the comparison condition is set to True or False, set the data pattern for the specified size in hexadecimal (Hex) or binary (Bin) notation.

Reference Values (a and b)

If the comparison condition is set to Data = A, Data ≠ a, a ≤ Data, Data ≤ b, a ≤ Data ≤ b, or "Data < a or b < Data," set the reference values in decimal notation. You must set the byte order (Endian), sign (Sign), and comparison range (MSB or LSB).

The selectable ranges are as follows:

Unsigned (Unsign)	0 to 9E+18 The selectable maximum value is limited by the data length and bit position, which are determined by the Size and MSB/LSB settings, respectively.
Signed (Sign)	-9E+18 to 9E+18 The selectable minimum and maximum values are limited by the data length and bit position, which are determined by the Size and MSB/LSB settings, respectively.

The value is displayed in scientific notation when the number of digits exceed seven (example: 1234567E+10).



If the comparison condition is $a \leq \text{Data} \leq b$ or “Data < a or b < Data,” the two reference values are automatically adjusted so that the lower limit is less than or equal to the upper limit.

Byte Order (Endian), Sign (Sign), and Comparison Range (MSB/LSB)

This item is the same as that of the CAN bus trigger.

▶ [See here.](#)

ID OR

The instrument triggers on the AND condition of SOF and multiple IDs.

The ID trigger condition is met when the ID matches any of the patterns that you set in ID1 to ID4.

- **Trigger Condition (Condition Setup)**

On the Condition Setup screen, set the PTYPE, ID, and other trigger conditions.

SOF

The instrument triggers on the start of a CXPI bus signal frame when the trigger condition is set to SOF only. SOF of ID OR is always selected as a trigger condition.

ID

- **with PTYPE**

The instrument triggers on whether a frame contains PTYPE.

Yes: Triggers on the ID of a frame containing PTYPE

No: Triggers on the ID of a frame not containing PTYPE

X: Triggers on the ID regardless of the presence of PTYPE

- **ID1 to ID4**

You can set up to four IDs. IDs whose check boxes are selected are used as trigger conditions.

The ID trigger condition is met when the input signal ID bit pattern matches any of the specified ID bit patterns. The method for setting the bit pattern of each ID is the same as with the ID/Data setting.

Wakeup/Sleep

The instrument triggers on any of the following: wakeup pulses, wakeup states, sleep frames, or sleep states.

- **Trigger Type (Type)**

Wakeup Pulse	When a pulse in the dominant period between 250 μ s and 2500 μ s is detected
Wakeup	When a transition from a state in which there is no clock after a sleep detection to a state in which there is a clock is detected
Sleep Frame	When the sleep frame ID value is 1F (hexadecimal)
Sleep	When 5 ms elapses after a transition is made from a state in which there is a clock to a state in which there is no clock

Source (Source)

Select the trigger source. After selecting the trigger source, configure the bit rate, T Sample, clock tolerance, HF rejection, trigger level, hysteresis, and other settings.

Source (Source)

Set the trigger source to one of the settings below.

CH1 to CH4

4 Triggering

Bit Rate (Bit Rate)

Select the CXPI bus signal's transfer rate from one of the settings below.

4800bps, 9600bps, 19200bps, User Define

If you select User Define, set the transfer rate in the range of 4000 bps to 50000 bps in 10-bps steps.

T Sample(T Sample)

Set the sum value, T Sample, for determining the logical value of the current bit.

The value in which T Sample is added to the low width of logical value 1 detected with the last bit is used as the threshold to determine the value as follows:

- Logical value 1 when the low width of the current bit is less than or equal to the threshold
- Logical value 0 when the low width of the current bit is greater than the threshold

Selectable range: 0.010 Tbit to 0.300 Tbit

Resolution: 0.001 Tbit

* Tbit is the time width of a bit calculated from the bit rate.

Clock Tolerance(Clock Tolerance)

Set the tolerance of the clock width calculated from the bit rate.

Selectable range: $\pm 0.5\%$ to $\pm 5.0\%$

Resolution: 0.1%

Level (Level), HF Rejection (HF Rejection)

Set these items for the trigger source.

These items are the same as those of the edge trigger.

▶ [See here.](#)

Hysteresis (Hysteresis)

This item is the same as that of the CAN bus trigger.

▶ [See here.](#)

Trigger Point

The following figure shows the trigger points.

• Normal Frame

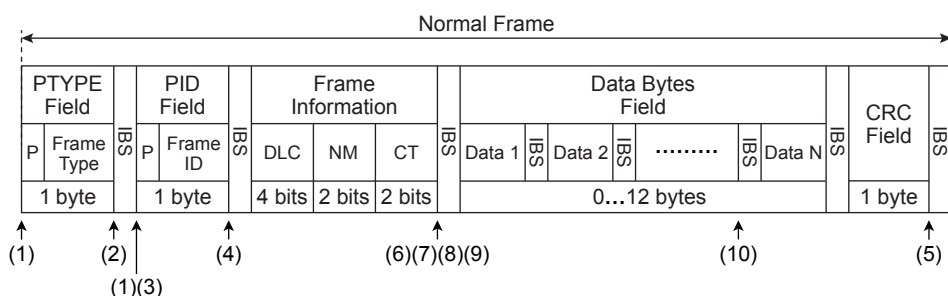

PTYPE is an option for the polling method.

Positions (1) to (9) above are trigger points for the following conditions.

(1) SOF	End position of the start bit of a PTYPE or PID field
(2) Every PTYPE	End position of the stop bit of a PTYPE field
(3) No Response	End position of the 10th consecutive bit with logical value 1 counted from the end position of the stop bit of the PTYPE field
(4) ID	End position of the stop bit of a PID field
(5) Sleep frame	End position of the stop bit of a CRC field
(6) Wakeup	End position of the stop bit of a frame information field
(7) Sleep	End position of the stop bit of a frame information field
(8) CT	End position of the stop bit of a frame information field
(9) Data (when Size = 0)	End position of the stop bit of a frame information field
(10) Data (when Size ≠ 0)	End position of the stop bit of a specified data bytes field

Error Trigger Points

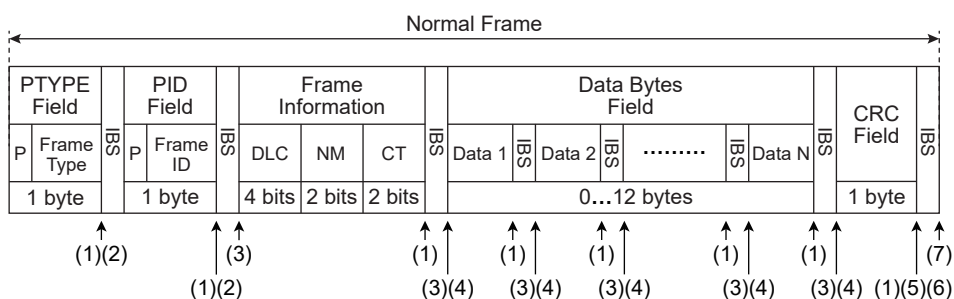

Positions (1) to (7) above are trigger points for the following errors.

(1) Framing Error	End position of the bit corresponding to the stop bit of each field
(2) Parity Error	End position of a PTYPE or PID stop bit
(3) IBS Error	End position of the 10th consecutive logical value 1 bit from the end position of the stop bit of each field (excluding PTYPE)
(4) Data Length Error (When data length < DLC)	End position of the 10th consecutive bit with logical value 1 counted from the end position of the stop bit of the last data bytes field
(5) CRC Error	End position of the stop bit of a CRC field
(6) Counter Error*	End position of the stop bit of a CRC field
(7) Data Length Error (When data length > DLC)	End position of the start bit of an exceeding byte field

* Counter Error is not a trigger point but a counter error detection point.

4 Triggering

• Long Frame

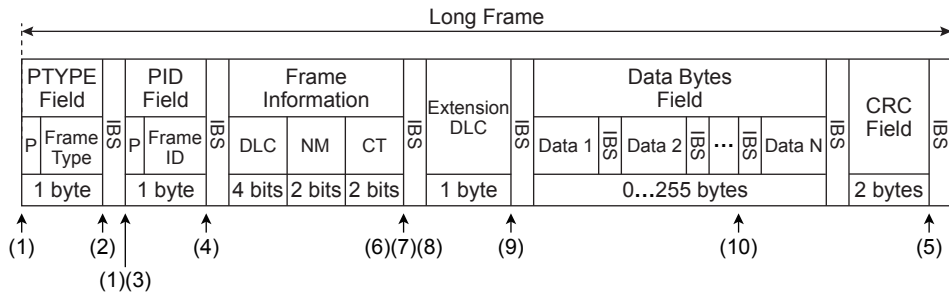

PTYPE is an option for the polling method.

Positions (1) to (9) above are trigger points for the following conditions.

(1) SOF	End position of the start bit of a PTYPE or PID field
(2) Every PTYPE	End position of the stop bit of a PTYPE field
(3) No Response	End position of the 10th consecutive bit with logical value 1 counted from the end position of the stop bit of the PTYPE field
(4) ID	End position of the stop bit of a PID field
(5) Sleep frame	End position of the stop bit of a CRC field
(6) Wakeup	End position of the stop bit of a frame information field
(7) Sleep	End position of the stop bit of a frame information field
(8) CT	End position of the stop bit of a frame information field
(9) Data (when Size = 0)	End position of the stop bit of a extension DLC field
(10) Data (when Size ≠ 0)	End position of the stop bit of a specified data bytes field

Error Trigger Points

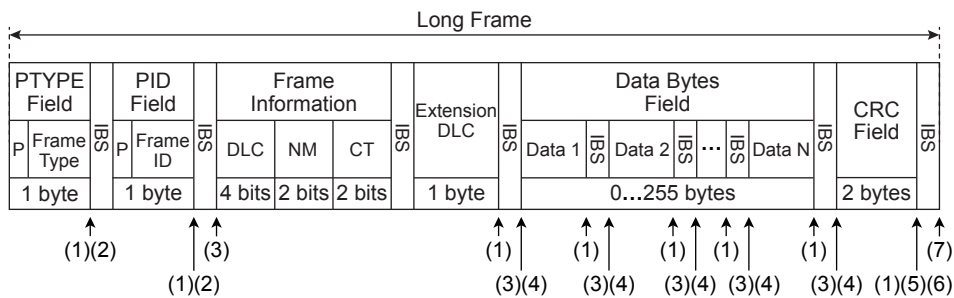

Positions (1) to (7) above are trigger points for the following errors.

(1) Framing Error	End position of the bit corresponding to the stop bit of each field
(2) Parity Error	End position of a PTYPE or PID stop bit
(3) IBS Error	End position of the 10th consecutive logical value 1 bit from the end position of the stop bit of each field (excluding PTYPE)
(4) Data Length Error (When data length < DLC)	End position of the 10th consecutive bit with logical value 1 counted from the end position of the stop bit of the last data bytes field
(5) CRC Error	End position of the stop bit of a CRC field
(6) Counter Error*	End position of the stop bit of a CRC field
(7) Data Length Error (When data length > DLC)	End position of the start bit of an exceeding byte field

* Counter Error is not a trigger point but a counter error detection point.

- **Wakeup Pulse**

The trigger point is the rising edge after a dominant period ranging from 250 μ s to 2500 μ s.

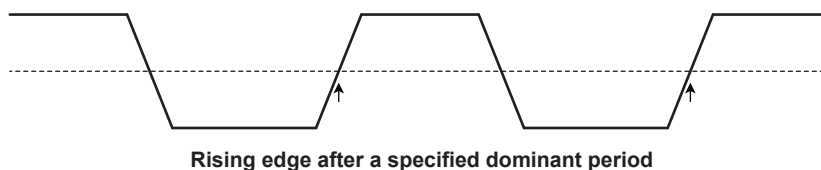

- **Wakeup/Sleep**

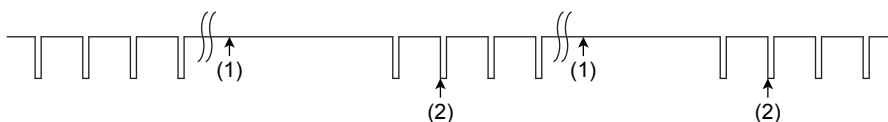

Positions (1) and (2) above are trigger points for the following conditions.

(1) Sleep	Position at 5 ms from the last falling edge of the ending clock
(2) Wakeup	Clock detection position after sleep (where 1 clock is guaranteed)

- **Clock Error**

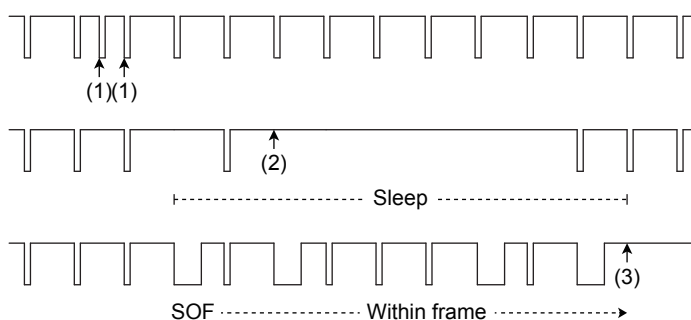

Positions (1) to (3) above are trigger points for the following conditions.

(1) Clock Error	Position where a clock less than clock error $1 \text{ Tbit} \times (1 - (\text{absolute value of clock tolerance})/100)$
(2) Clock Error	Position at $1 \text{ Tbit} \times + (\text{absolute value of clock tolerance})/100$ from the falling edge detected during sleep
(3) Clock Error	Position at $1 \text{ Tbit} \times (1 + (\text{absolute value of clock tolerance})/100)$ from the last falling edge of the ending clock within the frame

SENT Trigger [ENHANCED, option]

The instrument triggers on a specific pulse or nibble (Nibble) in a SENT signal. The following figure shows the SENT signal frame format.

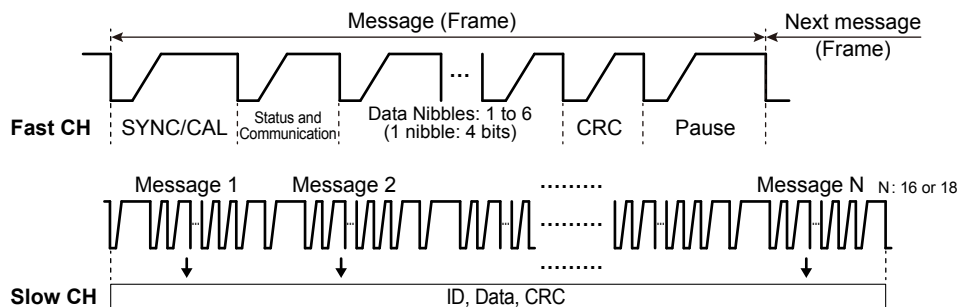

The instrument's SENT signal trigger circuit detects the section of the signal where the period between successive falling edges of the signal is 56 clock ticks* (including the specified clock tolerance) as SYNC/CAL. If consecutive 56-clock-tick signals occur, the last signal is detected as SYNC/CAL. The previous signals are handled as pause pulses or errors.

* In SENT signals, the reference clock period is expressed in clock ticks. The time between consecutive falling edges of the signal is counted using this period in order to detect SYNC/CAL and calculate nibble values.

Trigger Mode (Mode)

Select the SENT trigger mode from one of the settings below.

Every Fast CH: Triggers when a fast channel message is detected

Fast CH S&C: Triggers on the status and communication bit pattern

Fast CH Data: Triggers on the AND of the fast channel data

Every Slow CH: Triggers when a slow channel message is detected

Slow CH ID/ Data: Triggers on the AND of the slow channel ID and data

Error: Triggers on errors

Every Fast CH

The instrument triggers when it detects a fast channel message.

Fast CH S&C

The instrument triggers on the fast channel status and communication bit pattern.



- If you specify X in the bit pattern or data pattern, the condition is assumed to be met regardless of the corresponding bit status.
- In a bit pattern or data pattern setting, if a binary pattern contains any Xs, the corresponding hexadecimal display will be "\$."

- **Trigger Condition (Condition Setup)**

Set the 4-bit status and communication bit pattern in hexadecimal (Hex) or binary (Bin) notation. The trigger condition is met when the input signal status and communication bit pattern match the specified bit pattern.

Fast CH Data

The instrument triggers on the AND of fast channel Data conditions.

- **Data Type (Data Type)**

Select the fast channel data type from one of the settings below.

Nibble: Set a 4 to 24 bit data pattern in unit of nibbles (4 bits).

User: Set the data sizes of Data1 to Data4 in the range of 0 to 24 bits.

- **User Setup (User Setup)**

When the data type is USER, set the comparison conditions for Data1 to Data4, the data size, and nibble order.

Data size (Size): The total number of bits for Data1 to Data4 is up to 24. If you try to exceed the total number of bits, the data size of other pieces of Data is reduced.

Nibble order (Order): Select Big or Little.

When version is APR 2016 and Multiplexing is on, the data size of Data 1 is fixed to 4 bits to correspond to FC.

- **Trigger Condition (Condition Setup)**

Set the fast channel data trigger conditions.

When the data type is nibble

- **Comparison Condition (Condition)**

The data trigger condition is met when the result of comparing the data pattern to the input signal's data value meets the specified comparison condition.

True	When the value matches the data pattern
False	When the value does not match the data pattern

- **Data Pattern (Hex/Bin)**

Set the data pattern for the data nibble in hexadecimal (Hex) or binary (Bin) notation.

When the data type is User

- **Comparison Condition (Condition)**

The data trigger condition is met when the result of comparing the user-specified Data1 to Data4 values to the input signal's data value meets the specified comparison condition. Only the data pieces that were selected to be comparison conditions can be specified.

Data=a ¹	When the value is equal to the reference value
Data≠a ¹	When the value is not equal to the reference value
a≤Data ¹	When the value is greater than or equal to the reference value
Data≤b ¹	When the value is less than or equal to the reference value
a≤Data≤b ²	When the value is within the reference range (including the reference values)
Data<a, b<Data ²	When the value is outside the reference range (excluding the reference values)

1 Set one reference value

2 Set two reference values

- **Reference Values (a and b)**

Set the reference values in decimal notation.

Selectable range: 0 to 2^N-1

N: Data size (bits) assigned in User settings



If the comparison condition is $a \leq \text{Data} \leq b$ or "Data < a or b < Data," the two reference values are automatically adjusted so that the lower limit is less than or equal to the upper limit.

4 Triggering

Every Slow CH

The instrument triggers when it detects a slow channel message. To trigger using Every Slow CH, select the slow channel message type from one of the settings below.

This is selectable when the format version (explained later) is APR2016 or JAN2010.

- Short: Short message
- Enhanced: Enhanced message

Slow CH ID/Data

The instrument triggers on the AND of the slow channel ID and Data conditions.

- **Slow CH Type (Slow CH Type)**

This item is the same as that of “Every Slow CH” explained earlier.

▶ [See here.](#)

- **Trigger Condition (Condition Setup)**

Set the slow channel id/data trigger conditions.

When the message type is Short

- **Input Format (Input format)**

Set the ID and data pattern input format to Hex (hexadecimal) or Dec (decimal).

- Comparison Condition (Condition)

The data trigger condition is met when the result of comparing the ID and data reference values to the input signal’s ID and data values meets the specified comparison condition.

- Select whether to compare the ID or data. If you select both, the instrument triggers on the AND condition.
- Set the comparison conditions for ID and data.

Data	True ¹	When the value matches the specified data pattern
	False ¹	When the value does not match the specified data pattern
ID=a ²		When the value is equal to the reference value
Data=a ²		When the value is equal to the reference value
ID≠a ²		When the value is not equal to the reference value
Data≠a ²		When the value is not equal to the reference value
a≤ID ²		When the value is greater than or equal to the reference value
a≤Data ²		When the value is greater than or equal to the reference value
ID≤b ²		When the value is less than or equal to the reference value
Data≤b ²		When the value is less than or equal to the reference value
a≤ID≤b ³		When the value is within the reference range (including the reference values)
a≤Data≤b ³		When the value is within the reference range (including the reference values)
ID<a, b<ID ³		When the value is outside the reference range (excluding the reference values)
Data<a, b<Data ³		When the value is outside the reference range (excluding the reference values)

1 Set the data pattern for the data nibble in hexadecimal (Hex) or binary (Bin) notation. If the slow channel type is Short, set an 8 bit data pattern. If slow channel type is Enhanced and the ID and Data message format (explained later) ([Configuration bit](#)) is “12bit data, 8bit ID,” set a 12 bit data pattern. If the slow channel type Enhanced and the ID and Data message format is “16bit data, 4bit ID,” set a 16 bit data pattern.

2 Set one reference value

3 Set two reference values

- **Reference Values (a and b)**

Set the reference values in Hex (hexadecimal) or Dec (decimal) according to the input format. The selectable ranges are as follows:

ID		Data	
Hex	Dec	Hex	Dec
0 to F	0 to 15	00 to FF	0 to 255



If the comparison condition is $a \leq ID \leq b$, $a \leq Data \leq b$, “ID < a or b < ID,” or “Data < a or b < Data,” the two reference values are automatically adjusted so that the lower limit is less than or equal to the upper limit.

When the message type is Enhanced

- **Configuration bit**

Select the ID and data input format from one of the settings below.

- 12bit data, 8bit ID: When the data field is 12 bits and the message ID is 8 bits
- 16bit data, 4bit ID: When the data field is 16 bits and the message ID is 4 bits

- Input Format, Comparison Condition (Condition)

These are the same functions as when the message type is Short. ► [See here.](#)

- **Reference Values (a and b)**

Set the reference values in Hex (hexadecimal) or Dec (decimal) according to the input format. The selectable ranges are as follows:

Message Format	ID		Data	
	Hex	Dec	Hex	Dec
12bit data, 8bit ID	00 to FF	0 to 255	000 to FFF	0 to 4095
16bit data, 4bit ID	0 to F	0 to 15	0000 to FFFF	0 to 65535

Error

The instrument triggers when it detects various types of errors.

- **Error Type (Error Type OR)**

Select the types of errors to detect from the following. The instrument triggers if any of the selected errors is detected.

Successive CAL Pulses	The instrument triggers when successive SYNC/CAL pulses differ by 1/64 clock ticks or more. The comparison condition varies depending on the format setting (explained later).
Nibble Number	The instrument triggers when the number of nibbles in the message does not match the specified number of nibbles.. The specified number of nibbles varies depending on the number of data nibbles and the presence or absence of a pause pulse.
Nibble Data Value	The instrument triggers when any of the clock tick states of status and communication, Data, and CRC is outside the 12 to 27 clock tick range.
Fast CH CRC	The instrument triggers when it detects a fast channel CRC error.
Status and Communication	The instrument triggers when the status and Bit 0 or bit 1 is 1. Specify the bit to detect in the format settings (explained later).
Slow CH CRC	The instrument triggers when it detects a slow channel CRC error.

- **Slow CH Type (Slow CH Type)**

This item is the same as that of “Every Slow CH” explained earlier.

► [See here.](#)

4 Triggering

Format (Format)

Set the version and signal properties of the SENT signal.

Version

Set the version of the SENT signal.

APR2016: SENT signal complying with the version released in April 2016

JAN2010: SENT signal complying with the version released in January 2010

FEB2008 and older: SENT signal complying with the version released in February 2008 and earlier

Clock Tick

Set the reference clock period of SENT signals. The time between consecutive falling edges of the signal is counted using this period.

Selectable range: 1.00 μ s to 100.00 μ s

Resolution: 0.01 μ s

Clock Tolerance

Set the clock tick tolerance.

Selectable range: $\pm 1.0\%$ to $\pm 30.0\%$

Resolution: 0.1%

Data Nibbles

Set the number of data nibbles of fast channel messages.

Selectable range: 1 to 6

Pause Pulse

Select whether to include pause pulses in Fast CH messages. Select this for version APR2016 and JAN2010.

This is fixed to off for version FEB2008 and older.

ON: Pause pulses are included.

OFF: Pause pulses are not included.

CRC Type

Select the CRC type. Select this for version APR2016 and JAN2010. This is fixed to Legacy for version FEB2008 and older.

Recommended: CRC is added using the type recommended in version APR2016 or JAN2010.

Legacy: CRC is added using the type recommended in version FEB2008 and older.

Customize Error Factor

Select the method of detecting [error types](#) Successive CAL Pulses and Status and Communication.

- **Successive Calibration Pulses**

Select the method of detecting error type Successive CAL Pulses.

OFF: Errors are not detected.

Preferred Option: The calibration pulse of current frame is compared to the calibration pulse of the preceding frame to detect errors.

Option 2: The calibration pulse of current frame is compared to the calibration pulse of the last valid preceding frame to detect errors. However, if three consecutive errors are detected, the third calibration pulse is considered as valid.

- **Status and Communication**

Select the method of detecting error type Status and Communication. Select bit 0 or bit 1 or both. If you select both, errors are detected on the OR condition.

Bit 0: Bit 0 becoming 1 is detected as an error.

Bit 1: Bit 1 becoming 1 is detected as an error.

Source (Source)

Source (Source)

Set the trigger source to one of the settings below. If you select LOGIC, select the source bit. CH1 to CH4, LOGIC (Bit 0 to Bit 7)

Level (Level), HF Rejection (HF Rejection), Noise Rejection (Noise Rejection)*

Set these items for the trigger source.

These items are the same as those of the edge trigger.*

* You can set this only when the trigger source is set to LOGIC and the 701989 logic probe is connected.

▶ [See here.](#)

Hysteresis (Hysteresis)

You can set this only when the trigger source is CH1 to CH4.

This item is the same as that of the CAN bus trigger.

▶ [See here.](#)

Trigger Point

The following figures illustrate the trigger points. For other trigger points, see appendix 6.

▶ [See here.](#)

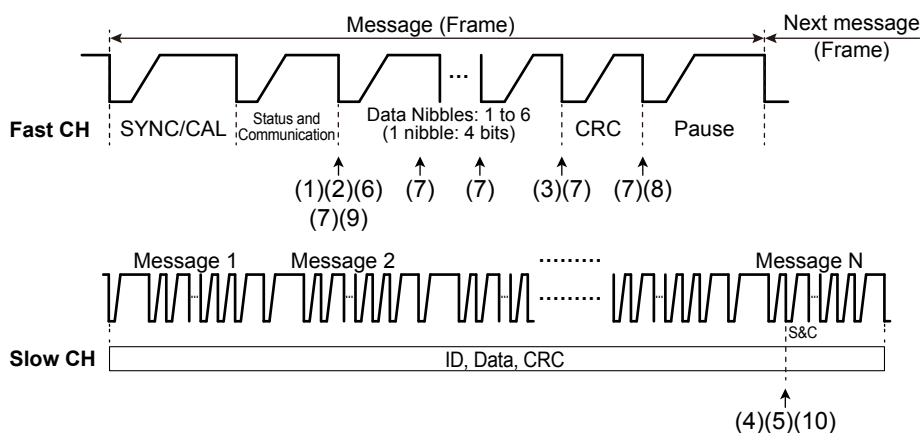

Positions (1) to (10) above are trigger points for the following conditions.

- (1) Every Fast CH
- (2) Fast CH S&C
- (3) Fast CH Data
- (4) Every Slow CH
- (5) Slow CH ID/Data
- (6) Successive CAL Pulses Error, detection method Option 2
- (7) Nibble Data Value Error
- (8) Fast CH CRC Error
- (9) Status and Communication Error
- (10) Slow CH CRC Error

UART Trigger [ENHANCED, option]

The instrument triggers on a UART signal. The following figure shows the UART signal data format for positive logic.

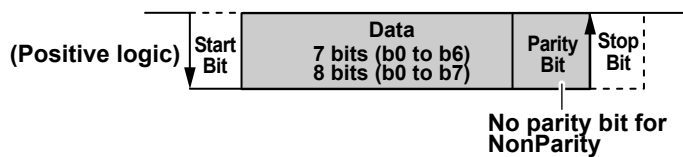

Trigger Mode (Mode)

Select the UART trigger mode from one of the settings below.

Every Data: Triggers on the data stop bit

Error: Triggers on errors

Data: Triggers on a data pattern

Every Data

The instrument triggers on the stop bit positions of all data frames.

Error

The instrument triggers when it detects various types of errors.

• Error Type (Error Type)

Select the types of errors to detect from the following. The instrument triggers if any of the selected errors is detected.

Framing	The instrument triggers when the logical stop bit value is zero.
Parity	When the instrument detects a parity error in a received character, the instrument triggers on the stop bit position. <ul style="list-style-type: none"> You can select which parity to check, odd or even. Errors will not occur if the parity bit is set to none.

Data

The instrument triggers on a specified data pattern.

• Trigger Condition (Condition Setup)

Data Length (Size)

Set how many consecutive data bytes will be compared.

Selectable range: 1 to 4 bytes

Comparison Condition (Condition)

The instrument triggers when the input signal data value matches the data pattern.

Input Format (Input Format)

For the data whose length was specified by Data Size, set the condition using a data pattern or ASCII character codes.

When using Pattern, set the data pattern using hexadecimal (Hex) or binary (Bin) notation.

If you use ASCII,

- Select whether uppercase and lowercase are considered when, as a trigger condition, the input signal data value is compared to the data pattern.
- Set the data pattern with the keyboard that appears on the screen.
- The special characters CR, LF, SP, and NUL are shown in single quotation marks. These special characters are counted as one character including the single quotation marks.
- The entered string, including the character codes for the case, is retained even if the input format is changed to Pattern. It is also retained when the format is changed from Pattern to ASCII.
- If a character code that does not exist on the keyboard is entered when the input format is Pattern and then the input format is changed to ASCII, a white square is displayed in the corresponding position.



When using binary or hexadecimal, if you set Xs in the data pattern, the corresponding bits will be considered satisfying the condition. If a binary pattern contains any Xs, the corresponding hexadecimal display will be "\$."

Source (Source)

Source (Source)

Set the trigger source to one of the settings below. If you select LOGIC, select the source bit. CH1 to CH4, LOGIC (Bit 0 to Bit 7)

Bit Rate (Bit Rate)

Select the UART signal's transfer rate from one of the settings below.

1200 bps, 2400 bps, 4800 bps, 9600 bps, 19200 bps, 38400 bps, 57600 bps, 115200 bps, User Define
If you select User Define, set the transfer rate in the range of 1000 bps to 10000000 bps in 100-bps steps.

Bit Order (Bit Order)

Set the bit order that is appropriate for the data stream.

When setting the data pattern, set the pattern MSB first regardless of the bit order setting.

MSB	When the data stream starts with the MSB
LSB	When the data stream starts with the LSB

Polarity (Polarity)

Select which bit state will be recognized to be logic 1.

	Positive logic
	Negative logic

Sample Point (Sample Point)

You can set the reference that will be used to determine the signal level in the range of 18.8 to 90.6% in 3.1% steps.

The instrument's UART signal trigger circuit samples the input UART signal using the internal clock and detects the point of level change. Set the sample point as a percentage, with the detected point of change equal to 0% and the point that is bit time after the point of change equal to 100%. The bit time is the inverse of the set bit rate.

▶ [See here.](#)

Level (Level), HF Rejection (HF Rejection), Noise Rejection (Noise Rejection)*

Set these items for the trigger source.

These items are the same as those of the edge trigger.*

* You can set this only when the trigger source is set to LOGIC and the 701989 logic probe is connected.

▶ [See here.](#)

Hysteresis (Hysteresis)

You can set this only when the trigger source is CH1 to CH4.

This item is the same as that of the CAN bus trigger.

▶ [See here.](#)

Format (Format)

You can select the data format from one of the settings below.

8bit No Parity	8-bit data (no parity bit)
7bit Parity	7-bit data + parity bit
8bit Parity	8-bit data + parity bit

Trigger Point

For all formats, in all modes, the trigger point is the stop bit after the trigger condition is met. If multiple data frames are specified, the trigger point is the stop bit of the last data byte.

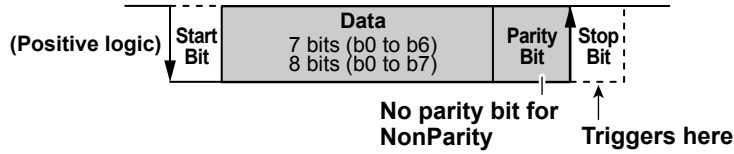

I²C Bus Trigger [ENHANCED, option]

The instrument triggers based on the I²C bus signal's start condition or the address pattern or data pattern trigger conditions. The following figure shows the I²C bus signal data format.

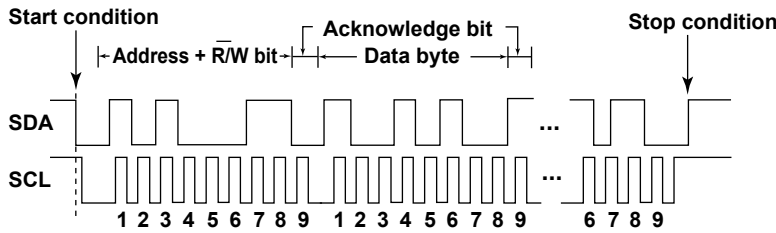

Serial Clock (SCL), Serial Data (SDA)

Source (Source)

Set the SCL and SDA source from one of the settings below. If you set the source to LOGIC, set the source bit (Bit0 to Bit7) and level.

CH1 to CH4, LOGIC (Bit 0 to Bit 7)

Level (Level), HF Rejection (HF Rejection), Noise Rejection (Noise Rejection)*

Set these items for the SCL and SDA sources. These items are the same as those of the edge trigger.*

* You can set this only when the trigger source is set to LOGIC and the 701989 logic probe is connected.

▶ See here.

Hysteresis (Hysteresis)

You can set this only when the trigger source is CH1 to CH4.

This item is the same as that of the CAN bus trigger.

▶ See here.

Trigger Mode (Mode)

Select I²C bus trigger mode from one of the settings below.

Every Start: Triggers on start or restart condition

Address Date: Triggers on the AND of address pattern and data pattern conditions

NON ACK: Triggers when the acknowledge bit is Nack (SDA is H)

General Call: Triggers on general call addresses

Start Byte: Triggers on the start byte master code

HS Mode: Triggers on the HS Mode master code

Every Start

When a start condition is detected, the instrument triggers on the SDA signal's falling edge.

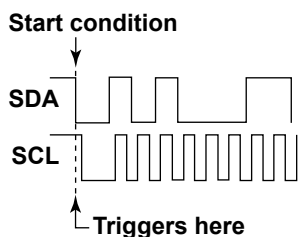

Address Data

The instrument triggers on the AND of Address and Data conditions.

If you do not select Address or Data, the instrument triggers on the start condition.

If you select only Address, the instrument triggers on the address acknowledge bit position.

If you select Data, the instrument triggers on the acknowledge bit position of the last byte of the applicable data.



If you specify X in the address or data pattern, the condition is assumed to be met regardless of the corresponding bit status.

In a address pattern or data pattern setting, if a binary pattern contains any Xs, the corresponding hexadecimal display will be "\$."

- **Trigger Condition (Condition Setup)**

On the Condition Setup screen, set the trigger conditions. The instrument triggers based on the Start (start condition), Address (address pattern), and Data (data pattern) items whose check box is selected.

Start (Start Condition)

If the only trigger condition is the start condition, when a start condition is detected, the instrument triggers on the SDA signal's falling edge.

Address

- **Type**

Set the address type to 7bit Address, 7bit + Sub Address, or 10bit Address.

- **Data Direction Bit Status (Direction)**

Set the data direction bit (R/W bit) to don't care (X), write (Write), or data request (Read). You can set this when the R/W bit is OFF.

- **Address Pattern (Hex/Bin)**

Set the address pattern for the data nibble in hexadecimal (Hex) or binary (Bin) notation. The address trigger condition is met when the specified address pattern matches the input signal address pattern.

If you set the input format to hexadecimal (Hex), the trigger condition is affected by whether the R/W bit is on or off.

7-bit Address Example

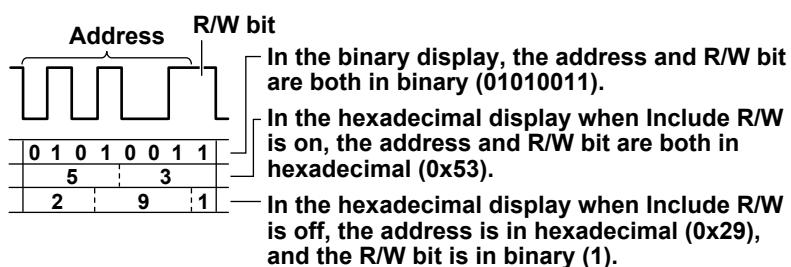

4 Triggering

Data

You can use a data pattern as a trigger condition.

- **Data Length (Size)**

Set how many consecutive data bytes will be compared.
Selectable range: 1 to 4 bytes

- **Comparison Start Position (Position)**

Set the comparison start position. The instrument skips the specified number of bytes and starts comparing from the next data byte. If you do not set the comparison start point, the data trigger condition is met when the input signal data pattern first matches the specified data pattern.
Selectable range: 0 to 9999 bytes

- **Comparison Condition (Condition)**

The data trigger condition is met when the relationship between the specified pattern and the input signal pattern meets the specified comparison condition.

True	When the patterns match
False	When the patterns do not match

- **Data Pattern (Hex/Bin)**

Set the data pattern for the specified data size in hexadecimal (Hex) or binary (Bin) notation.

- **R/W Bit Inclusion (Include R/W)**

Select whether to include or omit the R/W bit when you set the address pattern.

- ON: Include the R/W bit (address + R/W bit: hexadecimal or binary)
- OFF: Omit the R/W bit (address: hexadecimal or binary, R/W bit: set with Direction)



You can set R/W bit inclusion (Include R/W) under the conditions listed below. The setting is universal.

- When the I²C bus trigger type is Address Data.
 - When the I²C bus signal is being analyzed or searched.
-

Example (Address Data)

This example displays the data sequence at the byte level (hexadecimal notation) and indicates the trigger position. The following notations are used in the figure.

S: Start condition, P: Stop condition, Shading: Compared pattern

- **Trigger only on the address pattern**

Mode	Address Data
Address	7bit address, A4
Data	Don't care

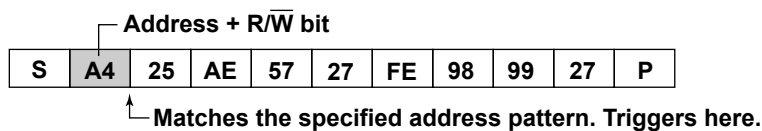

- **Trigger only on the data pattern**

Mode	Address Data
Address	Don't care
Data	Condition: True, Size: 2 bytes, Data pattern: 27 and AE

<When the position is not specified>

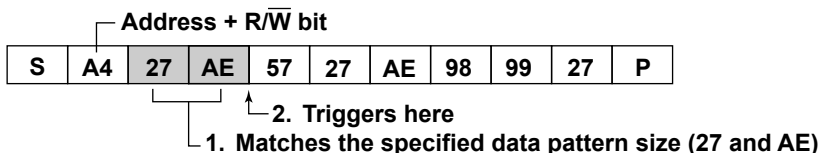

<When the position is set to 3>

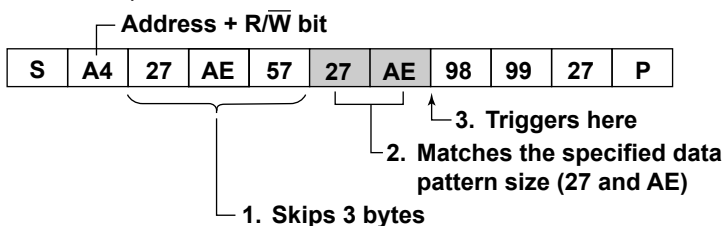

NON ACK

The instrument triggers when the acknowledge bit is Nack (when the SDA signal is high) at the acknowledge bit position.

You can select whether to use (OFF) or ignore (ON) the acknowledge bits that belong to the start byte (Start Byte), HS mode master code (HS Mode), and read access byte (Read Access).

General Call

When a general call address is detected, the instrument triggers on the acknowledge bit position of the second byte (address).

- **Trigger Condition (Condition Setup)**

On the Condition Setup screen, set the trigger conditions. The instrument triggers based on the general call and second byte items whose check box is selected.

General Call

The instrument triggers on the general call address (0000 0000). This is always set as a trigger condition.

Second Byte

You can use the second byte address pattern (the byte after the general call address) as a trigger condition. The second byte trigger condition is met when the input signal pattern matches the specified pattern. You can select the second byte address pattern (Type) from one of the settings below.

0000 0100	When the input signal pattern matches the pattern 0000 0100 (0x04)
0000 0110	When the input signal pattern matches the pattern 0000 0110 (0x06)
Master Address	When the input signal pattern matches the specified pattern, if you select Master Address, you can use the address or data pattern as a trigger condition.

Address/Data

When the second byte is set to Master Address, set the Address Data mode trigger condition.

▶ [See here.](#)

4 Triggering

Example (General Call)

This example displays the data sequence at the byte level (hexadecimal notation) and indicates the trigger position. The following notations are used in the figure.

S: Start condition, P: Stop condition, Shading: Compared pattern

- **Trigger only on the general call address**

Mode	General Call
Second Byte	Not selected

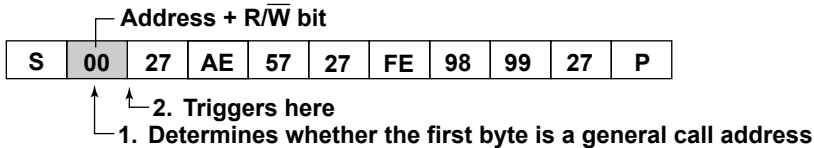

- **Trigger on a pattern whose second byte address is 06**

Mode	General Call
Second Byte	0000 0110

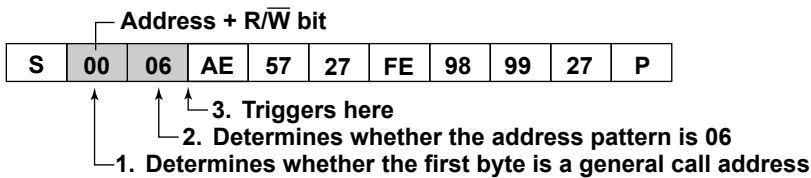

- **Trigger when the second byte address matches the specified pattern**

Mode	General Call
Second Byte	Master Address, Address pattern: 1010 1011 (0xAB)
Data	Condition: True, Size: 2 bytes, Data pattern: 2

<When the position is not specified>

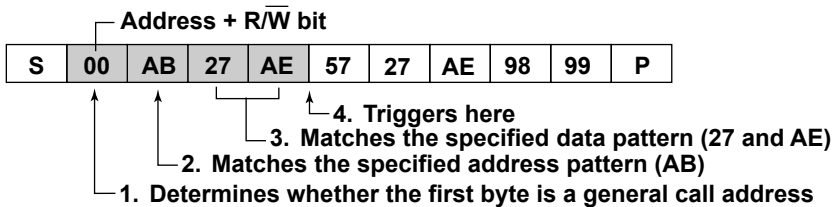

<When the position is set to 3>

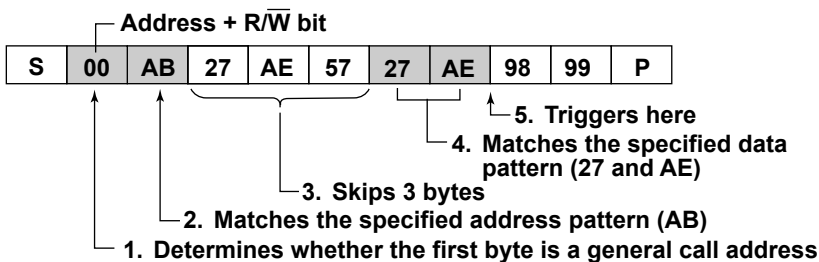

Start Byte

When a start byte master code (pattern: 0000 0001) is detected, the instrument triggers on the acknowledge bit position.

Example (Start Byte)

This example displays the data sequence at the byte level (hexadecimal notation) and indicates the trigger position. The following notations are used in the figure.

S: Start condition, Sr: Restart, P: Stop condition, Shading: Compared pattern

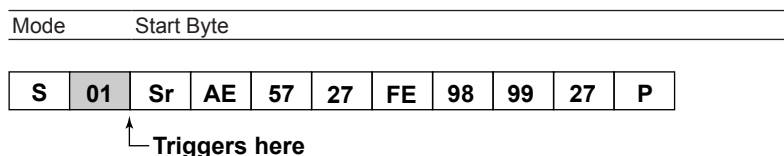
**HS Mode**

When an HS mode (high speed mode) master code (pattern: 0000 1XXX) is detected, the instrument triggers on the acknowledge bit position.

SPI Bus Trigger [ENHANCED, option]

The instrument triggers based on the conditions of SPI bus signal data patterns. The following figure shows the SPI bus signal timing chart.

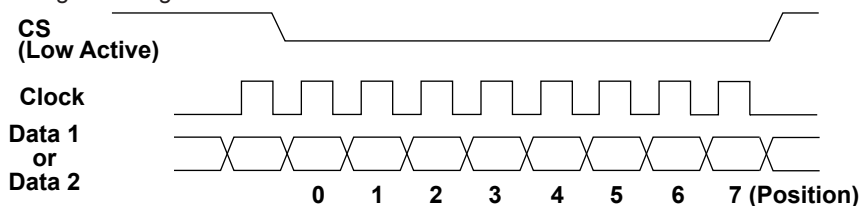
**Wiring System (Mode)**

Select from the following.

3 wire	The instrument triggers on the data pattern condition of one data line.
4 wire	The instrument triggers on the data pattern conditions of Data1 and Data2 lines. You can also use one of the two data lines as a trigger condition.

Clock (Clock)**Source (Source)**

Set the clock source to one of the settings below. If you select LOGIC, select the source bit. CH1 to CH4, LOGIC (Bit 0 to Bit 7)

Polarity (Polarity)

You can select which clock edge causes the data patterns to be compared.

\uparrow	On the rising edge
\downarrow	On the falling edge

4 Triggering

Data 1 or 2 (Data1/Data2)

You can use a data pattern as a trigger condition. When the wiring system is 3wire, only set Data1. When the wiring system is 4wire, set Data1 and Data2.

Source (Source)

Set the Data1 and Data2 sources from one of the settings below. If you select LOGIC, select the source bit. CH1 to CH4, LOGIC (Bit 0 to Bit 7)

CS(SS)

Source (Source)

Set the chip select source to one of the settings below. If you select LOGIC, select the source bit. CH1 to CH4, LOGIC (Bit 0 to Bit 7)

Active

You can select the chip select level for activating the data.

H	When the signal level is high
L	When the signal level is low

Trigger Condition (Condition Setup)

Bit Order (Bit Order)

Set the bit order that is appropriate for the data stream.

When setting the data pattern, set the pattern MSB first regardless of the bit order setting.

MSB	When the data stream starts with the MSB
LSB	When the data stream starts with the LSB

Data Length (Size)

Set how many consecutive data bytes will be compared.

Selectable range: 1 to 4 bytes

Comparison Start Position (Position)

Set the comparison start position. For example, to start comparing from the first data byte after the chip select signal is activated, specify zero. If you do not set the comparison start point, the data trigger condition is met when the input signal data pattern first matches the specified data pattern.

Selectable range: 0 to 9999 bytes

Comparison Condition (Condition)

The data trigger condition is met when the relationship between the specified pattern and the input signal pattern meets the specified comparison condition.

True	When the patterns match
False	When the patterns do not match

Data Pattern (Hex/Bin)

Set the data pattern for the specified data size in hexadecimal (Hex) or binary (Bin) notation.



If you specify X in the pattern, the condition is assumed to be met regardless of the corresponding bit status. If a binary pattern contains any Xs, the corresponding hexadecimal display will be "\$."

Level (Level), HF Rejection (HF Rejection), Noise Rejection (Noise Rejection)*

Set these items for Clock, Data1, Data2, and CS.

These items are the same as those of the edge trigger.*

* You can set this only when the trigger source is set to LOGIC and the 701989 logic probe is connected.

▶ [See here.](#)

Hysteresis (Hysteresis)

You can set this only when the trigger source is CH1 to CH4.

This item is the same as that of the CAN bus trigger.

▶ [See here.](#)

Trigger Point

The trigger point is determined by the clock polarity setting as follows:

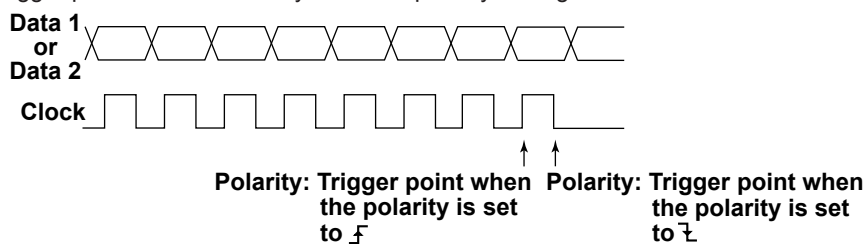
**Example**

This example displays the data sequence in hexadecimal (Hex) notation and indicates the trigger position.

The Data1 and Data2 pattern references are set to A1 and A2, respectively.

Shading: Pattern to compare

CS	Active: L
Data 1	Condition: True, Position: 0, Size: 2 bytes, Data pattern: A4 and 25
Data 2	Condition: True, Position: 6, Size: 2 bytes, Data pattern: 85 and C8

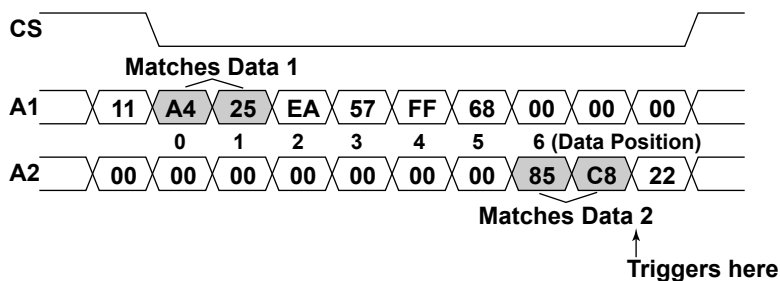

User-Defined Serial Bus Trigger [User Define, ENHANCED]

The instrument triggers based on the trigger conditions of user-defined serial bus signal data patterns.

Data (Source)

Data Source (Source)

Set the data source to one of the settings below. The available settings vary depending on the model.
CH1 to CH4

Active

Select which signal level, high or low, will be detected as 1.

H	Detects high level as 1
L	Detects low level as 1

Clock ON/OFF

You can select whether or not to sample the data source in sync with the selected clock source.

ON	Samples in sync with the clock source
OFF	Samples according to the bit rate.

Clock (Clock)

Set the clock that will be used to sample the data source.

Clock Source (Source)

Set the clock source to one of the settings below. The available settings vary depending on the model.
CH1 to CH4

Polarity (Polarity)

You can select which clock source edge causes the data source to be sampled.

\uparrow	On the rising edge
\downarrow	On the falling edge

Enable (Enable)

When the data source is sampled in sync with the clock source, whether sampling will be performed can be controlled with the enable signal.

Enable Source (Source)

Set enable source to one of the settings below. The available settings vary depending on the model.
CH1 to CH4, None (Enable is not used. Data source is detected at all times.)

Active

Select which signal level, high or low, will be used to test the data source.

H	Detects the data source when the signal level is high
L	Detects the data source when the signal level is low

Latch (Latch)



You can specify the timing at which the data source pattern sampled in sync with the clock source is compared with the specified pattern.

Latch Source (Source)

Set latch source to one of the settings below. The available settings vary depending on the model. CH1 to CH4, None (Latch is not used. Comparison is made for each clock.)

Polarity (Polarity)

You can select which latch source edge causes the data patterns to be compared.

	On the rising edge
	On the falling edge



You cannot set enable or latch on the 2-channel model.

Trigger Condition (Condition Setup)

You can use data patterns as trigger conditions. The data pattern trigger condition is met when the sampled data source pattern matches the specified pattern.

Data Length (Data Size)

Set the data pattern bit length.
Selectable range: 1 to 128 bits

Data Pattern (Hex/Bin)

Set the data pattern for the specified data size in hexadecimal (Hex) or binary (Bin) notation.
If you specify X in the pattern, the condition is assumed to be met regardless of the corresponding bit status.
If a binary pattern contains any Xs, the corresponding hexadecimal display will be "\$."

Bit Rate (Bit Rate)

If the clock is set to OFF, the instrument samples the data source at the specified bit rate.
Selectable range: 1 kbps to 50 Mbps (in 1 kbps steps)

Level (Level), HF Rejection (HF Rejection)

Set these items for data, clock, enable, and latch.
These items are the same as those of the edge trigger.

▶ [See here.](#)

Hysteresis (Hysteresis)

This item is the same as that of the CAN bus trigger.

▶ [See here.](#)

4 Triggering

Example

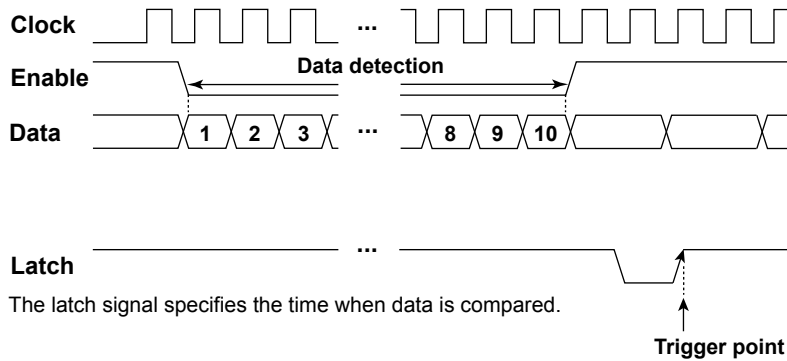

TV Trigger [ENHANCED]

The instrument triggers based on the trigger conditions of a particular field or line in a TV signal.

Broadcasting System (Type)

Set the broadcasting system to one of the settings below.

NTSC(525/60/2)

PAL(625/50/2)

SDTV(480/60p)

HDTV(1080/60i, 1080/50i, 720/60p, 1080/25p, 1080/24p, 1080/24sF, 1080/60p)

UserdefTV: Specify appropriate settings such as the definition (SD or HD), horizontal sync frequency, and sync guard frequency.

Trigger Source (Source)

Set the trigger source to a channel from CH1 to CH4. The available settings vary depending on the model.

Polarity (Polarity)

Select which polarity the TV signal must be with respect to the trigger level for the instrument to trigger.

Pos	Positive
Neg	Negative

Trigger Level (Level)

Set the trigger level in units of divisions with the peak value equal to 0 divisions.

Selectable range: 0.1 to 2.0 div

Resolution: 0.1 div

The default setting is 0.5 divisions.

Line Number (Line)

Set the trigger source line number.

- One: The instrument triggers on the start of the selected line number.
- All: The instrument triggers on all lines.

The selectable range for various broadcasting systems is as follows:

Broadcasting System	Range
NTSC	5 to 1054
PAL	2 to 1251
SDTV	8 to 2251
HDTV	2 to 2251
User Define	2 to 2251

Field Number (Field)

Select the field number to detect.

You can only set the field number for NTSC, PAL, or HDTV (1080/60i, 1080/50i, or 1080/24sF).

1	Detects fields whose vertical sync pulse starts at the same time as the start of a line
2	Detects fields whose vertical sync pulse starts 1/2H (where H is the horizontal scanning period) behind the start of a line
X	Detects both

Frame Skip (Frame Skip)

This feature skips frames in cases such as when the color burst is inverted for every frame. You can select how many frames to skip.

1	The instrument triggers on the specified field of every frame.
2	The instrument skips 1 frame and triggers on the specified field on the subsequent frame. This operation is repeated every 2 frames.
4	The instrument skips 3 frame and triggers on the specified field on the subsequent frame. This operation is repeated every 4 frames.
8	The instrument skips 7 frame and triggers on the specified field on the subsequent frame. This operation is repeated every 8 frames.



HF rejection settings are ignored.

NTSC Example

The following line numbers are those when the field number is set to 1

(if the field number is set to 2, the numbers are assigned sequentially by setting 268 to 5).

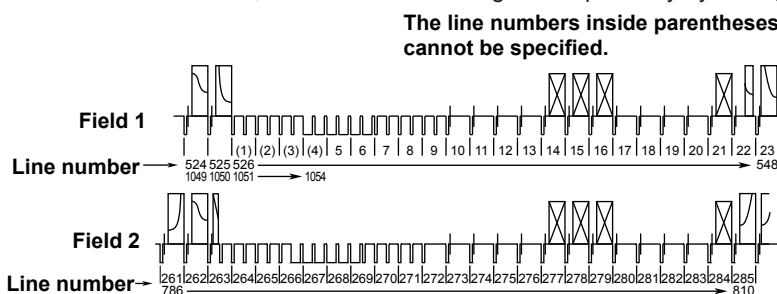

PAL Example

The following line numbers are those when the field number is set to 1

(if the field number is set to 2, the numbers are assigned sequentially by setting 315 to 2).

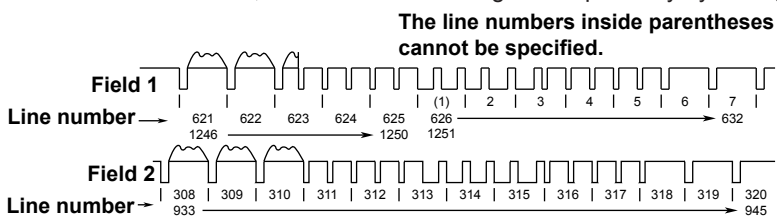

SDTV Example

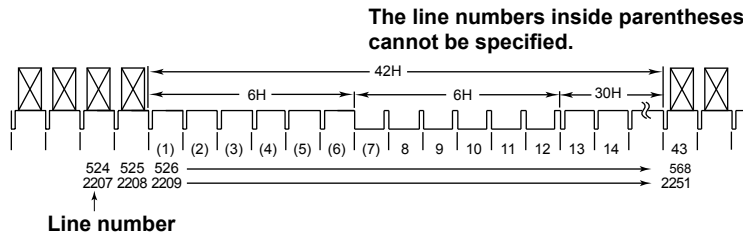

HDTV Example

- **Example for 1080/60i, 1080/50i, or 1080/24sF**

The following line numbers are those when the field number is set to 1 (if the field number is set to 2, the numbers are assigned sequentially by setting 565 to 2).

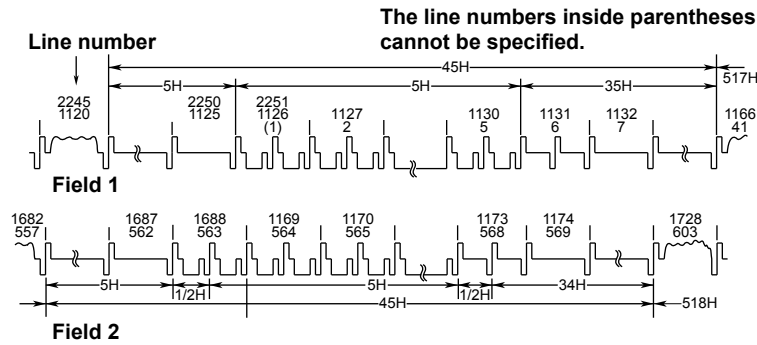

- **720/60p Example**

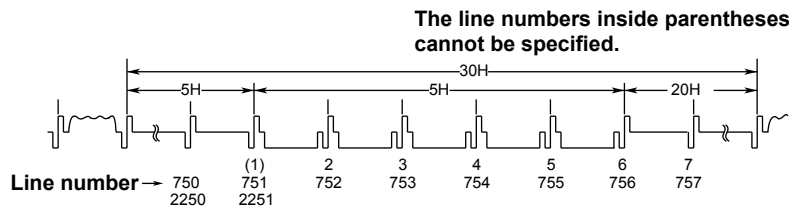

- **Example for 1080/25p, 1080/24p, or 1080/60p**

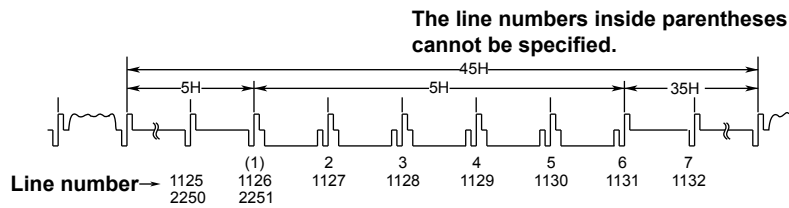

User Defined (Userdef TV)

Define appropriate values for definition, horizontal sync frequency, sync guard frequency, etc.

Trigger Source (Source), Polarity (Polarity), Trigger Level (Level)

Line Number (Line), Field Number (Field), Frame Skip (Frame Skip)

These items are the same as when a specific broadcasting system is specified.

▶ [See here.](#)

HF Rejection (HF Rejection)

Select whether or not to eliminate high-frequency components (300 kHz or higher) from the trigger source.

300kHz: Eliminates high-frequency components greater than or equal to 300 kHz

OFF: Does not eliminate high-frequency components



When the broadcasting system is not set to User Define, the HF rejection setting is as follows:

NTSC, PAL, or SDTV: Fixed at 300 kHz

HDTV: Fixed at OFF

Horizontal Sync Frequency (HSync)

Set the horizontal sync frequency. Pressing the RESET key sets the frequency to 31.5 kHz.

Sync Guard Frequency (Sync Guard)

Set the sync guard frequency as a percentage of the horizontal sync frequency.

Pressing the RESET key sets the frequency to 70%/Hsync.

Definition (Definition)

Set the definition to one of the settings below.

SD: Standard (bi-level sync signal)

HD: High definition (tri-level sync signal)

Trigger B [B TRIG]

Trigger B is the trigger you set using the B TRIG key.

The instrument can trigger on the combination of trigger A (condition A) and trigger B (condition B).

The trigger conditions you set using the EDGE or ENHANCED key are the trigger A conditions. The trigger conditions you set using the B TRIG key menu are the trigger B conditions.

Trigger Combination (Combination)

Set how to combine trigger A and B conditions.

- OFF: The instrument triggers only on the trigger A conditions (the trigger B conditions are not used).
- A Delay B: After the trigger A conditions are met and the specified amount of time elapses, the instrument triggers when the trigger B conditions are met.
- A to B(N): After the trigger A conditions are met, the instrument triggers when the trigger B conditions are met N times.

Example**A Delay B Trigger**

After the trigger A conditions are met and the specified amount of time elapses, the instrument triggers when the trigger B conditions are first met.

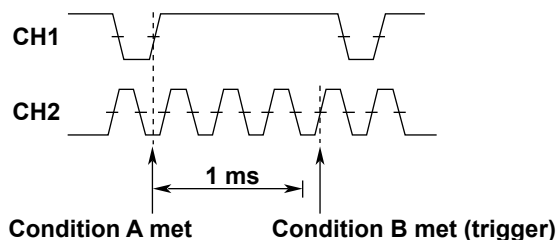

Condition A: Edge trigger, CH1 = \uparrow ,
Condition B: Edge trigger, CH2 = \uparrow , Delay = 1 ms

4 Triggering

A to B(N) Trigger

After the trigger A conditions are met, the instrument triggers when the trigger B conditions are met N times.

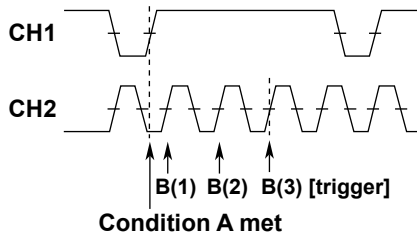

Condition A: Edge trigger, CH1 = \overline{F} ,
Condition B: Edge trigger, CH2 = \overline{F} , N = 3

Trigger A (A Trigger)

The trigger A conditions are set using the menu that corresponds to the EDGE or ENHANCED key, whichever is illuminated.

Trigger B (B Trigger)

Configure trigger B (condition B). You can use the following triggers.

Edge trigger, Edge OR trigger, Pattern trigger, Window trigger, Window OR trigger, Serial Bus trigger



- If you set trigger condition A to serial bus trigger, you cannot set trigger condition B to serial bus trigger.
- The trigger level is shared between trigger A and trigger B. If the trigger type of one of the triggers has two levels (upper level and lower level) and that of the other has one level, the center value of the two levels and the single level are shared.

Configuring the Trigger B Conditions

The items that you can set vary depending on the A and B trigger types that you selected.

- **A Delay B Trigger**

Configure these items for trigger B: trigger type, trigger source, trigger level, delay, and other settings.

The trigger type, trigger source, and trigger level settings are the same as those in the EDGE or ENHANCED key menu.

Delay (Delay)

Selectable range: 10 ns to 10 s

Resolution: 2 ns

- **A to B(N) Trigger**

Configure these items for trigger B: trigger type, trigger source, trigger level, the number of times condition B must be met, and other settings. The trigger type, trigger source, and trigger level settings are the same as those in the EDGE or ENHANCED key menu.

Number of Times Condition B Must Be Met (N Count)

Selectable range: 1 to 10^9

5 Executing Actions

A specific action can be executed when trigger conditions are met (this feature is called action-on-trigger) or when the GO/NO-GO determination result is no-go. You can set the number of times to execute the action in terms of the number of waveform acquisitions or the number of determinations.

Logic signals cannot be used as source waveforms for rectangular zone, waveform zone, or polygonal zone in GO/NO-GO determination.

Action Mode (Mode)

Select the action mode from one of the following three settings.

- Action on Trig (trigger): Executes the specified action each time the trigger condition is met
- [Go/Nogo AND](#) (GO/NO-GO determination): Executes the specified action each time all of the reference conditions are no-go
- [Go/Nogo OR](#) (GO/NO-GO determination): Executes the specified action each time any of the reference conditions are no-go

Action to Execute When Conditions Are Met (Action)

The instrument executes the specified action each time the conditions are met. You can specify any of the four actions below.

Buzzer (Buzzer)

Sounds an alarm.

Print or Save the Screen Image (Print)

Prints the screen image to the printer (Printer (built-in printer), USB (USB printer)) specified by "Print to" in the PRINT menu or stores the screen image data to the specified storage device.

Save the Waveform Data (SaveWaveform)

Stores the waveform data in binary or ASCII format to the destination (internal storage, USB storage) specified using the FILE menu. Specify the file type using Data Type in the FILE menu.

▶ [See here.](#)

Send Mail (Send Mail)

The instrument sends an e-mail to the specified address. Set the email address by pressing UTILITY and then selecting Network > Mail.

▶ [See here.](#)

- **Mail Count**

Sets the upper email transmission limit. When the number of transmitted emails reaches Mail Count, the instrument stops sending emails.

- **Contents of Emails That the Instrument Sends (Action on Trig)**

<Subject>: The subject attached to the email. For example: "Action Triggered Report (nth action)"

[Comment]: Comment

[Trigger Date and Time]: The time of trigger occurrence

[Action Count]: The number of actions performed

5 Executing Actions

- **Contents of Emails That the Instrument Sends (Go/Nogo AND, Go/Nogo OR)**

<Subject>: The subject attached to the email. For example: "GoNogo Triggered Report (Nth Nogo result)"

[Comment]: Comment

[Setup Information]: Reference conditions (contents of condition numbers 1 to 4), Logic (AND/OR), Stop Nogo/Action Count ((the number of no-go results/the number of actions)

[Trigger Date and Time]: The time of trigger occurrence

[Nogo/Exec Count]: The number Nogo results/the number of judgments performed

[Nogo Factor]: Information, including measured values, about the conditions that returned no-go results*

* Measured values are only sent for GO/NO-GO determination based on waveform parameters.

Example

[Comment] Test

[Setup Information]

Select1: Rect(C1,Main) (Left:-3.0000E+00,Right:-2.5000E+00,Upper: 500.00E-03,Lower:-500.00E-03,Condition:In)

Select2: Wave(C1,Main) (Range1:-5.0000E+00,Range2: 5.0000E+00,Condition:In)

Select3: Polygon(C1,Main) (Condition:In)

Select4: Measure(Max(C1)) (Upper: 0.0000E+00,Lower: 0.0000E+00,Condition:In)

Logic: OR

Stop Nogo/Action Count: 1/Inf

[Trigger Date and Time] 2018/06/01 21:18:51

[Nogo/Exec Count] 1/1

[Nogo Factor]

Select1: Rect(C1,Main)

Select2: Wave(C1,Main)

Number of Actions (Action Count/Nogo Count)

When the number of waveform acquisitions reaches the specified action count or when the number of no-go results reaches the specified Nogo Count, the instrument stops waveform acquisition.

Action Count

Set the number of waveform acquisitions.

1 to 1000000: The instrument stops the action when it acquires the specified number of waveforms.

Infinite (0): The instrument repeats the action until waveform acquisition is stopped using the Abort soft key or the RUN/STOP key.

Nogo Count

Set the number of no-go results.

- 1 to 1000: When the specified number of no-go results is reached, the instrument stops GO/NO-GO determination.

- Infinite (0): The instrument repeats GO/NO-GO determination until waveform acquisition is stopped using the Abort soft key or the RUN/STOP key.

Executing Action-on-Trigger or GO/NO-GO determination (Exec)

Press the Exec soft key. You cannot use the RUN/STOP key for this purpose. During execution, the Exec soft key changes to the Abort soft key. The trigger mode during action-on-trigger or GO/NO-GO determination is set to Normal (this setting is independent from the front-panel MODE key).

Press the Abort soft key to stop action-on-trigger or GO/NO-GO determination.

GO/NO-GO Determination (Go/Nogo AND, Go/Nogo OR)

The instrument determines whether the acquired waveform meets the reference condition (no-go result) or not (go result). When the instrument produces a no-go result, it executes the specified action.

You can specify up to four reference conditions. You can also apply AND or OR logic to the four reference conditions.

In the reference conditions, you can include a zone or values obtained from automated measurement of waveform parameters.

The determination result can be transmitted through the rear-panel GO/NO-GO output terminal.

- Go/Nogo AND: Executes the action when all reference conditions 1 to 4 are no-go
- Go/Nogo OR: Executes the action when any of the reference conditions (1 through 4) are no-go

Reference Conditions (1 to 4)

For reference conditions 1 to 4,* set the source waveform, reference range (the zone or the waveform parameter upper and lower limits), and the reference criterion.

* 1 and 2 on the 2-channel model.

Reference Criterion (Condition)

Set whether the source waveform must be in or out of the reference range to produce a no-go result.

- IN: No-go when the source waveform is within the reference range
- OUT: No-go when the source waveform is outside the reference range

Source Waveform (Trace)

You can select from one of the settings below. If you select LOGIC, select the [source bit](#).

CH1 to CH4/LOGIC*, Math1 to Math4, XY1, XY2, FFT1, FFT2

* CH4 or LOGIC, whichever the corresponding key is illuminated, can be selected.

Selectable Reference Range Types for Various Source Waveforms

	Rect	Wave	Polygon	Parameter
CH1 to CH4	Yes	Yes	Yes	Yes
LOGIC	No	No	No	Yes
Math1 to Math4	Yes	Yes	Yes	Yes
XY1, XY2	Yes	No	Yes	Yes
FFT1, FFT2	No	No	No	Yes

Reference Range Type (Mode)

You can set the reference range type to one of the settings below.

- OFF: The source waveform is not used for GO/NO-GO determination.
- [RectZone](#): Rectangular zone.
- [WaveZone](#): Waveform zone.
- [PolygonZone](#): Polygonal zone.
- [Parameter](#): Zone between the upper and lower limits of one waveform parameter.



Reference conditions 1 through 4 share their settings with history waveform search conditions 1 through 4.

Creating a Rectangular Zone (RectZone)

To create a rectangle, use the jog shuttle or the SET key to set the top, bottom, right, and left boundaries of the rectangle.

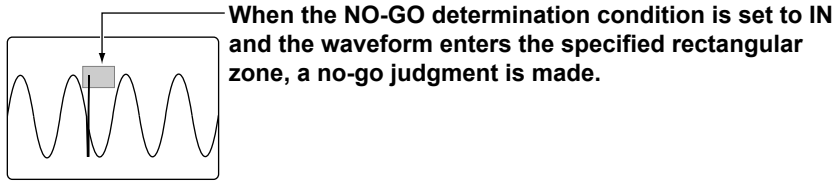

Creating a Rectangular Zone (Upper/Lower and Left/Right)

Create a rectangular zone.

- The selectable range for top and bottom boundaries is ± 4 divisions from the screen center in 0.01-division steps.
- The selectable range for left and right boundaries is ± 5 divisions from the screen center in 0.01-division steps.

Determination Source Window (Range)

If the source waveform is CH1 to CH4, Math1 to Math4, set the GO/NO-GO determination source window to one of the following options:

- Main: Main window
- Zoom1: Zoom1 window
- Zoom2: Zoom2 window



Rectangular zone does not appear when the determination source waveform display is set to off.

Creating a Waveform Zone (WaveZone)

Create a zone based on the source waveform. You can also use other waveforms to create the zone.¹ You can create up to four waveform zones. One of them is used for GO/NO-GO determination.

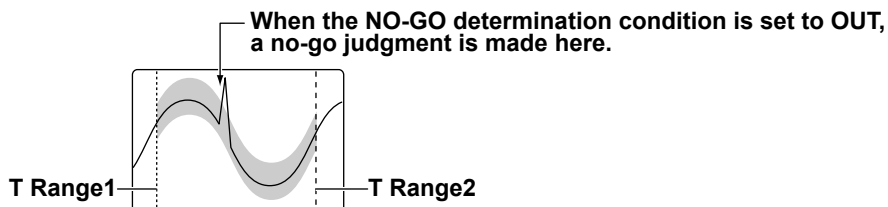

Determination Source Window (Range)

Select the GO/NO-GO determination source window. The selection process is the same as with the rectangular zone.

▶ [See here.](#)

Selecting the Waveform Zone (Zone No.)

Select the number of the waveform zone you want to edit. GO/NO-GO determination is performed using the waveform zone that you select here.

Editing a Waveform Zone (Edit1 to 4)

Create a vertical or horizontal zone on the entire waveform or on a portion of the waveform.

The waveform zones that you create are stored in the internal memory even when the power is turned off. You can save and load waveform zones from the internal storage or an external storage device using the FILE menu.

▶ [See here.](#)

Specifying the Editing Range (Edit)

You can specify which portion of the base waveform you want to edit.

- Whole: Edit the entire waveform
- Part: Edit a portion of the waveform

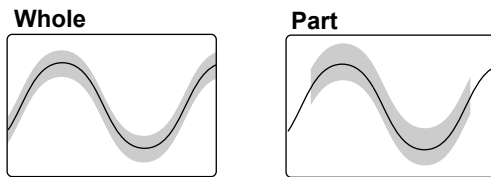
**Setting Zones (Upper/Lower, Left/Right and T Range1/T Range2)**

Set vertical or horizontal zones.

- Selectable vertical zone range: ± 8 divisions from the base waveform
- Selectable horizontal zone range: ± 5 divisions from the screen center
- * When you select Whole, use Left and Right to set the zones. When you select Part, use T-Range1 and T-Range2 to set the zones.

Changing the Base Waveform (Trace)

You can select the base waveform for creating the waveform zone from one of the settings below. Change the base waveform when you want to use a waveform other than the GO/NO-GO determination source waveform or when you want to recreate the zone. You cannot select waveforms whose display is turned off.

CH1 to CH4, Math1 to Math4

Starting Over the Editing (Exec)

To start over the editing of the waveform zones, press this soft key. If you press this key, all the zones that you have edited up to that point will be lost.



If you want to continue editing existing zones, do not press this soft key. Even if you press the Exec soft key and clear the zones, the original zones are stored if you have stored them in the past according to the procedure explained in "Confirming the Waveform Zones" on the next page. If you want to go back and edit the original zones, press the Quit soft key to finish editing once, and then press one of the Edit 1 to 4 soft keys to enter the edit menu again.

Confirming the Waveform Zone (Store)

Confirms the waveform zone.

Finishing the Editing Operation (Quit)

Finish waveform zone editing. If you do not confirm the edited waveform zone by pressing the Store soft key, the changes that you made are lost.

Determination Period (T Range1 and T Range2)

The instrument performs GO/NO-GO determination on the waveform in the area specified by T Range1 and T Range2.

Selectable range: Within ± 5 divisions of the time axis

5 Executing Actions

Creating a Polygonal Zone (PolygonZone)

You can use polygonal zones by using polygon images. You can create polygon images by using the Mask Editor Software on a PC. You can create up to four polygonal zones and use one of them for GO/NO-GO determination.

You can download the Mask Editor Software from the YOKOGAWA website.

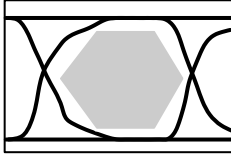

Loading a Polygon Image

Using the FILE Menu, load a polygon image into the specified zone (Zone No.1 to 4).

Determination Source Window (Range)

Select the GO/NO-GO determination source window. The selection process is the same as with the rectangular zone.

▶ [See here.](#)

Selecting the Polygonal Zone (Zone No.)

Select the zone number that contains the polygon image that you want to use for determination.

Moving the Polygonal Zone (V-Position, H-Position)

You can move the loaded polygon image vertically or horizontally.

Selectable V-Position range: ± 4 divisions

Selectable H-Position range: ± 5 divisions

Setting the Reference Range Using a Waveform Parameter (Parameter)

Set upper and lower limits on a measured item obtained through the automated measurement of waveform parameters.

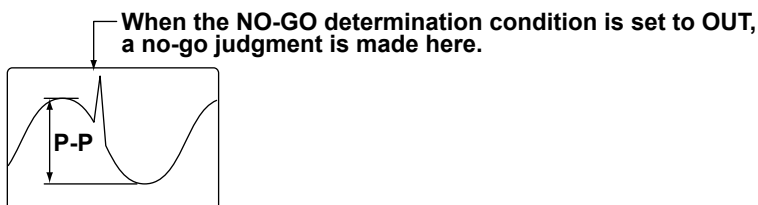

Selecting the Measured Item to Use for Determination (Item)

The selectable item varies depending on the determination source waveform (Trace) that you selected.

- CH1 to CH8, Math1 to Math4: All measurement items
- LOGIC: Freq, Period, Avg Freq, Duty, Pulse Count, Delay
- XY1, XY2: Integ only
- FFT1, FFT2: Peak cursor only

Reference Range (Upper/Lower)

Set the upper and lower limits of the reference range.

Notes about Action



How the instrument operates when the action setting is Print or Save Waveform

- The instrument operates based on the settings in the Print menu or FILE menu. If the auto naming feature in the FILE menu is off, files are saved using sequence numbers (Numbering). If it is not off, the files are saved using the specified method.
- If the instrument's internal storage is being accessed from a PC while an action is being executed, the PC may stop detecting the internal storage. If this happens, remove the USB cable connecting the PC to the instrument, wait a few seconds, and reconnect the cable.

Points to Consider When Configuring Action-on-Trigger

- You cannot change settings while the action-on-trigger feature is active.
- Exponential averaging is used.

Notes about GO/NO-GO Determination

- The instrument displays the determination results on the screen (the total number of results and the number of no-go results).
- During GO/NO-GO determination, only the Abort soft key and RUN/STOP are valid.
- The instrument automatically changes the trigger mode to Normal when it executes GO/NO-GO determination.

Points to Consider when Setting the Action Setting to Print

- If Print To is set to Multi on the PRINT menu, you cannot execute the action.

Points to Consider When Setting the Action Setting to Save Waveform

- Do not set the storage device's root folder as the save destination.
- If you set sequential numbering as the automatic naming method (using the FILE menu), as the number of saved files increases, the amount of time required to save a file will also increase. Also, the maximum number of files that can be saved using sequential numbering is 1000. To save more than 1000 files, set the automatic naming function so that files are named by date.
- If you use the automatic naming function to save data to files, GO/NO-GO determination will stop if the same file name exists in the same folder. To prevent this from happening, you can either create a new empty folder before you start GO/NO-GO determination, or you can make sure that there are no files in the destination folder.
- Up to 2500 files and folders can be displayed in the file list. If there are more than a total of 2500 files and folders in a given folder, the file list for that folder will display only 2500 files and folders. There is no way to set which files and folders are displayed.

Points to Consider When Setting the Action Setting to Send Mail

- The instrument operates based on the settings that you specified by pressing UTILITY and selecting Network > Mail. You can attach screen images to emails.
 - We recommend that you set a limit on the mail transmission number to avoid overloading the mail server. You can set the upper limit of mail transmissions using Mail Count.
 - If the specified number of mail transmissions is less than the number of specified actions, mail transmission will stop after the specified number of transmissions. If the specified number of mail transmissions is greater than the number of specified actions, mail transmission will stop after the specified number of actions.
-

6 Waveform Acquisition

Based on the data that has been stored in the acquisition memory, the instrument performs various operations, such as displaying waveforms on the screen, computing, measuring cursors, and automatically measuring waveform parameters.

This chapter explains how to set the number of data points to store in the acquisition memory (the record length), how to enable or disable the sample data averaging feature, and so on.

Record length (Record Length)

Record length refers to the number of data points that are stored to the acquisition memory for each channel.

Display record length refers to the data points from the data stored in the acquisition memory that are displayed on the screen. Normally, the acquisition-memory record length and display record length are the same, but the time scale may cause them to differ.

When you change the time scale, the sample rate and record length also change.

The instrument allows you to set the record length to a value from 1.25 kpoints to 500 Mpoints (this range varies depending on the installed option).

If you want to observe a long-term phenomenon at a high time resolution (at a high sample rate), set the record length to a high value.

When the record length is long, computation and measurement processing take longer than when the record length is short.

The following limitations on waveform acquisition conditions and the number of waveforms that can be stored in the acquisition memory (the number of history waveforms) apply depending on the specified record length.

Record Length	Number of History Waveforms		
	No options (125 Mpoints)	/M1 option (250 Mpoints)	/M2 option (500 Mpoints)
1.25 kpoints	20000	50000	100000
12.5 kpoints	2500	5000	10000
125 kpoints	250	500	1000
1.25 Mpoints	25	50	100
2.5 Mpoints	10	25	50
5 Mpoints	5	10	25
12.5 Mpoints	1	5	10
25 Mpoints	1 ¹	1	2
50 Mpoints	1 ²	1 ¹	1
125 Mpoints	1 ^{2, 3}	1 ²	1 ¹
250 Mpoints	–	1 ^{2, 3}	1 ²
500 Mpoints	–	–	1 ^{2, 3}

- 1 Waveform acquisition operates in Single mode at this record length regardless of the trigger mode setting. You cannot specify Envelope.
- 2 Waveform acquisition operates in Single mode at this record length regardless of the trigger mode setting. You cannot specify Envelope, Averaging, or Interpolation mode.
- 3 CH2 and CH4 (LOGIC) waveforms cannot be acquired at this record length. Math2 (Ref2) and Math4 (Ref4) are also unavailable.

Acquisition mode (Mode)

Select from the following.

Normal Mode (Normal)

Displays waveforms without processing the sampled data.

Envelope Mode (Envelope)

The instrument determines the maximum and minimum values among the data sampled at 2.5 GS/s at the time interval that is 2 times of the sampling period (the inverse of the sample rate) of the Normal mode setting and displays the values as pairs to produce the waveform.

This mode is effective when you want to avoid aliasing, because the sample rate is essentially kept high regardless of the time axis setting. It is also effective when you want to detect glitches (narrow pulse signals) or when you want to display the envelope of a modulated signal. This mode can be used when the sample rate is 625 MS/s or less.

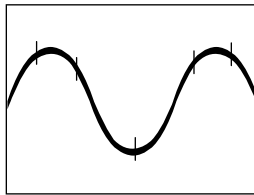

Normal mode

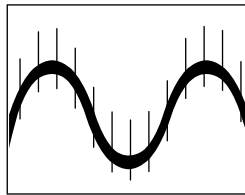

Envelope mode



If you set the acquisition mode to Envelope when the sample rate is set to 1.25 GS/s or higher, the instrument actually operates in Normal mode. In envelope mode, [Envelope] appears in the upper right of the screen. If envelope is in use in high resolution mode, [Env:Hi-Res] appears.

Averaging Mode (Average)

In Averaging mode, the instrument acquires waveforms numerous times, averages the same time points relative to the trigger point, and displays averaged waveforms. Averaging mode is useful when you want to remove random noise from waveforms.

You cannot use the history feature in Averaging mode.

The averaging method varies depending on the trigger mode.

- Auto, Auto Level, or Normal mode: Exponential averaging
- Single mode: Linear averaging
- N Single mode: Actually operates in Normal mode.



To average waveforms that have been acquired in N Single mode, set the acquisition mode to Normal, and turn on history feature's averaging.

Attenuation Constant and Average Count (Avg Count)

Sets the attenuation constant for exponential averaging or the average count for linear averaging.

Selectable range: 2 to 1024

Exponential average

$$A_n = \frac{1}{N} \{(N - 1)A_{n-1} + X_n\}$$

A_n: nth averaged value
 X_n: nth measured value
 N: Attenuation constant
 (2 to 1024 in 2ⁿ steps)

Simple average

$$A_n = \frac{\sum_{n=1}^N X_n}{N}$$

X_n: nth measured value
 N: Number of times to average
 (2 to 1024 in 2ⁿ steps)



Logic waveforms are not averaged.

Number of Waveform Acquisitions (ACQ Count)

When the acquisition mode is set to Normal (Normal) or Envelope (Envelope), you can set the number of waveform acquisitions. If you select Infinite, the instrument continues waveform acquisition until you stop it using the RUN/STOP key. The default setting is Infinite. You cannot change the number of acquisitions during waveform acquisition. If you want to change it, stop acquisition first.

Selectable range: 1 to 65536, or Infinite



The number of waveforms that have been stored to the acquisition memory appears at the upper left of the screen.

High Resolution Mode (Hi Resolution)

When High Resolution mode is turned on, the number of effective bits per data value is expanded by up to 12 bits through the digital and bandwidth filters (Band Width).

- ON: Enables High Resolution mode
- OFF: Disables High Resolution mode



-
- When High Resolution mode is turned on, the maximum sample rate of real-time sampling is set to 1.25 GS/s, half the ordinary value.
 - High Resolution mode does not apply to logic waveforms.
-

Sampling Mode (Sampling Mode)

The instrument samples data using a 2.5 GS/s A/D converter, so the maximum sample rate in normal sampling mode (real-time sampling mode) is 2.5 GS/s.

If you decrease the time axis setting when measuring fast phenomena, the sample rate will reach its maximum rate (2.5 GS/s) at a certain point. If you decrease the time axis setting further, the number of displayed points decreases (the display record length decreases).

The instrument has two modes for interpolating between deficient data points. Set the sampling mode when you want to make measurements by setting a sample rate that is higher than the real-time sampling mode's maximum sample rate (2.5 GS/s).

- Interpolation mode: Interpolates between data points using the $(\sin x)/x$ function. This mode is effective for single-shot signals.
- Repetitive sampling mode: Interpolates through random sampling. This mode is effective for repeating signals.

Relationship between the Time Scale, Record Length, and Sample Rate

The relationship between the time scale, record length, and sample rate is as follows:

When the record length and the time axis are set so that the sample rate is at the maximum rate, if you decrease the time axis setting further, the record length is reduced.

$$\text{Sample rate} = \text{Record length} / (\text{time scale [s/div]} \times 10 [\text{div}])$$

Real-Time Sampling Mode (Realtime)

When you change the time axis setting, the sample rate changes. You can sample data at a maximum sample rate of 2.5 GS/s (1.25 GS/s when High Resolution mode is on).

In this mode, the instrument can only display waveforms up to the frequency that corresponds to one-half the sample rate, in accordance with the sampling theorem.* Therefore, this mode is suitable for observing waveforms whose frequency is lower than one-half the sample rate.

- * If the sample rate is comparatively low with respect to the input signal frequency, the harmonics contained in the signal are lost. When this happens, some of the harmonics will be misread as low-frequency waves due to the effects described by the Nyquist sampling theorem. This phenomenon is called aliasing. You can avoid aliasing by acquiring waveforms with the acquisition mode set to Envelope.

Interpolation Mode (Interpolation)

In Interpolation mode, the instrument interpolates the data sampled at 2.5 GS/s up to 100 times using the $(\sin x)/x$ function.

This essentially increases the sample rate to up to 250 GS/s.

The interpolation mode is effective for single-shot signals. If the input signal frequency is high relative to the sample rate (2.5 GS/s here), aliasing may occur.

You can use the history feature in Interpolation mode.

Repetitive Sampling Mode (Repetitive)

In this mode, one waveform is created from several cycles of a repeating signal. This is equivalent to sampling the signal at a higher sample rate than the actual sample rate. The equivalent sample rate is 250 GS/s maximum.

The instrument uses random sampling, which takes advantage of the fact that the time difference between the trigger point and sampled points is random. The instrument realigns the trigger point each time it acquires a waveform.

This mode is effective for repeating signals, and aliasing rarely occurs.

You cannot use the history feature in Repetitive Sampling mode.



- Even if Interpolation or Repetitive Sampling mode is selected, the instrument runs in real-time sampling mode when the sample rate is less than or equal to 2.5 GS/s. When the instrument is running in Interpolation or Repetitive Sampling mode, “IntP” or “Rep” appears at the upper right of the screen.
- When the sample rate is at its maximum rate (250 GS/s) in Interpolation or Repetitive Sampling mode, if you decrease the time axis setting, the display record length is reduced.
- If the trigger mode is set to Single or N Single, the acquisition mode is set to Averaging, and the sampling mode is set to Repetitive Sampling, the instrument actually runs in Interpolation mode.
- If the trigger mode is set to N Single and the sampling mode is set to Repetitive Sampling, the instrument actually runs in Interpolation mode.
- Repetitive Sampling mode can only be used when the record length is 1.25 Mpoints or less. If the trigger source is set to LOGIC, the instrument runs in Interpolation mode.

Waveform Acquisition (RUN/STOP)

When you execute (RUN) waveform acquisition, the instrument stores waveform data to the acquisition memory and updates the displayed waveforms each time the instrument triggers. The acquisition memory is divided into many areas based on the specified record length, and the maximum number of acquirable waveforms are stored in the memory. You can recall past waveforms that are stored in the memory using the history feature when waveform acquisition is not running.

How the Instrument Operates When the Acquisition Mode Is Set to Averaging

- Averaging stops when you stop acquisition.
- If you execute acquisition again, averaging starts from the beginning.

RUN and STOP Operations during Accumulation

- Accumulation stops when you stop waveform acquisition.
- When you execute acquisition again, the displayed waveforms up to that point are cleared, and accumulation restarts from the beginning.

The RUN/STOP Key Is Disabled:

- When the instrument is in remote mode.
- When the instrument is printing to a printer, when it is being set up automatically, or when it is accessing a storage device.



- If you press HISTORY during waveform acquisition, waveform acquisition stops.
- If you change the waveform acquisition conditions and, waveform acquisition, the past data stored in the acquisition memory is cleared.
- You can use the snapshot feature to retain the displayed waveform on the screen. This feature allows you to update the display without having to stop waveform acquisition.
- To update the displayed waveform once when the trigger condition is met and then stop waveform acquisition, press SINGLE.

Acquiring the Waveform Once (SINGLE)

When you execute waveform acquisition (SINGLE) and trigger conditions are met, the instrument updates the displayed waveform once and stops waveform acquisition. If no triggers occur, the display is not updated. If no triggers occur, the display is not updated. If TIME/DIV is set to a value that would cause the display to switch to roll mode (100 ms/div to 500 s/div), roll mode is used until a trigger occurs. When the instrument triggers, roll mode will stop when it acquires the record length's post-trigger data. This mode is suitable for the observation of single-shot signals.

7 Display

Types of Windows

This instrument has the following types of windows.

VT waveform display window

- Main window
Displays normal waveforms, which are not magnified
- Zoom1 window
Displays zoomed waveforms according to the settings specified using the ZOOM1 key.
- Zoom2 window
Displays zoomed waveforms according to the settings specified using the ZOOM2 key.

XY window

- XY1 window
Displays the XY1 waveform according to the settings specified using the X-Y key.
- XY2 window¹
Displays the XY2 waveform according to the settings specified using the X-Y key.

FFT window²

Displays the FFT1 and FF2¹ waveforms according to the settings specified by the FFT key.

Trend/Histogram window^{2, 3}

Displays Trend1, Trend2, Hist1, and Hist2 according to the statistical processing settings specified using the MEASURE key.

- 1 XY2 and FFT2 waveforms are only available on 4-channel models.
- 2 The FFT window and the Trend/Histogram window are the same.
- 3 Only Trend1 or Hist1 can be displayed on 2-channel models. Up to two items can be displayed on 4-channel models.

Display Example

<Main>		
<Zoom1>		<Zoom2>
<XY1>	<XY2>	<FFT, Trend, Histogram>

Display Format (Format)

You can evenly divide the VT waveform display window so that you can easily view input waveforms and computed waveforms. You can divide the window in the following ways.

Auto,¹ Single (one area), Dual (two areas), Triad (three areas), Quad (four areas), Hexa (six areas),² Octal (eight areas)²

- 1 The number of areas is automatically selected based on the number of displayed waveforms.
- 2 Only on 4-channel models



The number of displayed points per area varies depending on how many areas the window is divided into.

The vertical resolution does not change even if the number of displayed points is different.

The number of displayed points when only the Main window is displayed is as follows:

Single: 640 points, Dual: 320 points, Triad: 208 points, Quad: 160 points, Hexa: 104 points, Octal: 80 points

Waveform Mapping (Mapping)

You can specify how channels are assigned to the divided areas.

- **Auto**

The waveforms whose display is turned on are assigned in order starting with the top area.

- **Manual**

You can assign each waveform to the area of your choice.

You can assign all waveforms regardless of whether their displays are turned on.

Color (Color)

Intensity (Intensity Graticule)

You can set the intensity of the grid (Grid), zoom box (Zoom Box), cursor (Cursor), and marker (Marker).

Selectable range: 0 to 31

Waveform Color (Waveform)

You can select the waveform display color separately for CH1 to CH4,* LOGIC,* State,* and Math1 to Math4 from the available 16 colors.

- * The waveform display color for CH4 can be selected only when the CH4 key is illuminated, and the colors for LOGIC and state can be selected when the LOGIC key is illuminated.

Serial Bus Trend Color (Serial Bus Trend)

The instrument has a function that analyzes and decodes certain serial bus signals and displays the trend of the results. You can select the color of each trend from 16 colors.

For details on the analysis, decoding, and trend display of serial bus signals, see chapter 15, "Analyzing and Searching Serial Bus Signals." ► [See here.](#)

Initialization

Intensity and color can be reset to default values.

- To reset the intensity of the grid, zoom box, cursor, or marker to its default value, select the item that you want to reset, and then press RESET.
- To reset the colors of the waveform and serial bus trend, press DEFAULT SETUP. However, be careful as pressing DEFAULT SETUP will also reset other settings to their factory default values. ► [See here.](#)

Display Interpolation (Dot Connect)

When the number of data points is within the interpolation zone,* the instrument displays waveforms by interpolating between sampled data points.

- * Interpolation zone refers to the condition in which a given number of data points are not contained in the 10 divisions along the time axis. The number of data points that define the interpolation zone varies depending on the display record length and zoom factor.

You can set the interpolation method to one of the options below.

- **Sine (Sine Interpolation)**

Interpolates a sine curve between two points using the $(\sin x)/x$ function. This method is suitable for the observation of sine waves.

- **Line (Linear Interpolation)**

Linear interpolation is performed between two points.

- **Pulse (Pulse Interpolation)**

Interpolates between two points in a staircase pattern.

- **OFF**

Displays the data using dots without interpolation.

When the Number of Displayed Waveform Data Points Is Not in the Interpolation Zone

If the interpolation method is set to Sine, Line, or Pulse, the dots are connected vertically.

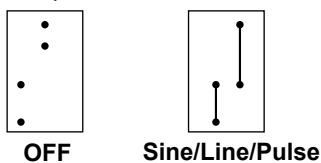

When the Number of Displayed Waveform Data Points Is in the Interpolation Zone

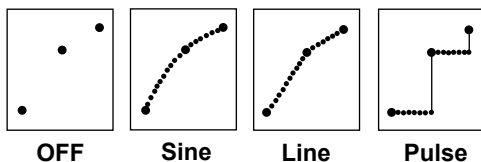

The interpolation method is set to Pulse when:

- The input signal is a logic signal.
- The acquisition mode is Envelope.
- The sampling mode is Repetitive Sampling.

Graticule (Graticule)

Set the window grid to one of the settings below.

- Dot Grid: Displays the grid using broken lines
- Line Grid: Displays the grid using solid lines
- Frame: Displays a frame
- Cross Hair: Displays the grid using crosshairs

Fine Grid Display (Fine Grid)

You can set whether or not to display the fine grid.

- ON: Displays the fine grid
- OFF: Does not display the fine grid

Scale Value Display (Scale Value)

You can display the upper and lower limits (scale values) of each waveform's vertical or horizontal axes.

- ON: Displays the scale values
- OFF: Does not display the scale values

Waveform Intensity (Intensity)

You can set the waveform brightness.

Selectable range: 1 to 64

Accumulation (Accumulate)

When you turn the accumulate feature on, the instrument acquires waveforms at a rate independent of the screen update interval and accumulates them on the screen.

The accumulated waveforms are displayed with gradually decreasing intensity for the specified amount of time. The accumulated display can be used to increase the waveform acquisition rate and retain waveforms of infrequent phenomenon on the screen for a certain amount of time.

If accumulation is turned off, the screen is updated every time a trigger occurs, and waveforms are not accumulated. The waveform acquisition rate never becomes faster than the screen refresh interval of the display, but this is effective when you want to focus on the waveform acquired once.

Gradation Mode

You can set the gradation mode to one of the settings below. Gradation is not applicable to logic signals.

- **Intensity**

Indicates frequency using different intensity levels. The intensity range is 1 to 64.

- **Color**

Indicates frequency using different colors. Indicates 15 frequency levels using different colors that range from blue to green to yellow to red to white starting with the lowest frequency.

- **OFF**

Does not accumulate waveforms.

Accumulation Time (Accum Time)

Sets the amount of time to retain waveforms on the screen.

Selectable range

100 ms to 100 s, or Infinite (Infinite)



-
- If you press CLR, the accumulated waveforms are cleared.

Notes about Waveform Accumulation

- Automated measurement of waveform parameters and GO/NO-GO determination are performed on the most recent waveform.
 - If you press RUN/STOP to stop waveform acquisition, accumulation stops. When you restart waveform acquisition, all the waveforms are cleared, and accumulation starts from the beginning.
 - If the instrument does not trigger when the trigger mode is set to Normal, the waveform intensity is retained until the next time the instrument triggers.
 - If you change the display format when accumulated waveforms are displayed, the instrument operates in the following manner.
 - During accumulation: The instrument clears the screen and restarts from the beginning.
 - When accumulation is stopped: The instrument clears the waveforms and displays the most recent waveform.
-

8 Displaying XY Waveforms

You can view the correlation between two input signal levels by assigning the level of a waveform to the X-axis (horizontal axis) and assigning the level of another waveform to the Y-axis (vertical axis). XY waveforms appear in the XY window.

You can perform cursor measurements on and determine the area of the displayed XY waveform. You can view XY waveforms and normal VT waveforms simultaneously.

For example, you can use the XY waveform display to measure the area of safe operation (SOA) of switching elements.

You can configure up to two XY waveforms: XY1 and XY2.*

* Only XY1 on the 2-channel model.

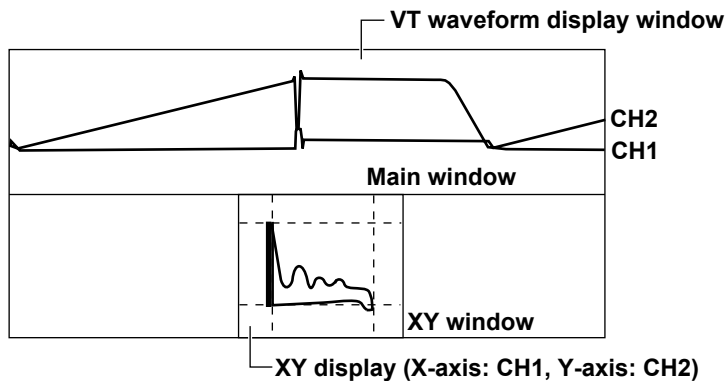

Turning the XY Waveform Display On and Off (Display)

Sets whether or not to measure and display XY waveforms. If you set this to ON, the XY window appears.

- ON: Displays and measures XY waveforms
- OFF: Does not display or measure XY waveforms

X-Axis and Y-Axis Source Waveforms (X Trace/Y Trace)

Select the waveforms to assign to the X-axes and Y-axes of the XY1 and XY2 waveforms. The available settings vary depending on the model.

CH1 to CH4, Math1 to Math4

Configuring the Display (Display Setup)

Displaying the VT Waveforms (VT Display)

Sets whether or not to display XY waveforms along with the VT waveforms.

- ON: Displays the VT waveform display window
- OFF: Does not display the VT waveform display window

Split Display (Split)

Sets whether or not to display the XY1 and XY2 waveforms in separate windows.

- ON: Enables the split display
- OFF: Disables the split display



If you press DISPLAY, ZOOM1, or ZOOM2 when the VT waveform display (VT Display) is OFF, the VT waveform display window turns on.

Display Source Window (Time Range)

Set the display and measurement range source window to one of the settings below.

Main: Main window
Zoom1: Zoom1 window
Zoom2: Zoom2 window

Display Area (T Range1/T Range2)

Sets the start point (T Range1) and the end point (T Range2) of the display and the measurement time period. Selectable range: ± 5 divisions with the center of the target window taken to be 0 divisions.

Measurement (Measure Setup)

Configures settings for cursor measurement and area calculation.

OFF

Disables measurement.

Cursor Measurement (Cursor)

You can display two cursors on both the X and Y axes and measure with them simultaneously.

- **Vertical cursor**

You can measure the X-axis values for Cursor1 and Cursor2. You can set the cursors in the range of ± 4 divisions in 0.01-division steps.

- **Horizontal cursor**

You can measure the Y-axis values for Cursor1 and Cursor2. You can set the cursors in the range of ± 4 divisions in 0.01-division steps.

- **Measurement Item (Item)**

The instrument measures the values of the items listed below that you select.

X1: X axis value at Cursor1

Y1: Y axis value at Cursor1

X2: X axis value at Cursor2

Y2: Y axis value at Cursor2

ΔX : Difference between the X1 and X2 values

ΔY : Difference between the Y1 and Y2 values

Area (Integ)

Determines the total areas of the XY1 and XY2 waveforms. You can set the loop and polarity for each XY waveform.

- **Loop**

Sets the method of determining the area to Open (total trapezoidal area) or Close (total triangular area).

- **Polarity**

Selects which direction to make positive, CW (clockwise) or CCW (counterclockwise).

9 Computed and Reference Waveforms

The instrument can display up to four computed or reference waveforms (Math/Ref1 to Math/Ref4).*

* Only MATH1/REF1 and Math/Ref2 on 2-channel models

Computation Mode (Mode)

Select the waveforms that will be displayed for Math/Ref1 to Math/Ref4 from one of the settings below.

OFF: Does not display computed or reference waveforms

Math: Displays computed waveforms

Ref: Displays reference waveforms



- When the state display of the logic signal is on, Math4/Ref4 cannot be used.
 - Even if Ref is selected, it appears as Math1 to Math4 in the various source selection menus.
-

Computation Source Waveforms (Source1/Source2)

If you set the computation mode to Math, you can select the computation source waveforms for Math/Ref1 to Math/Ref4 from one of the settings below.

Depending on the operator, you may need to select only Source1 or Source1 and Source2. The available settings vary depending on the model.

- Math1 (Math/Ref1): CH1 to CH4
- Math2 (Math/Ref2): CH1 to CH4, Math1*
- Math3 (Math/Ref3): CH1 to CH4, Math1, * Math2*
- Math4 (Math/Ref4): CH1 to CH4, Math1* to Math3*

* If Ref is selected, even if it is displayed as Math1 to Math3 on the source selection menu, the computation source is Ref1 to Ref3.

Reference Waveforms

If you set the computation mode to Ref, you can display reference waveforms. The following waveforms can be used as reference waveforms.

- Waveforms displayed on the screen: You can load waveforms using the Load from soft key.
- Waveforms saved in the past: You can load waveforms using the load feature of the FILE menu.

Loading the Reference Waveform (Load from)

The reference waveform is set to the waveform displayed on the screen. Select the waveform to load into Ref1 to Ref4 from one of the settings below. Data that exceeds 25 Mpoints is loaded by sampling.

CH1 to CH4, Math1* to Math4*

*You cannot select Math1 for Ref1, Math2 for Ref2, Math3 for Ref3, or Math4 for Ref4.

Measurement and Computation Using Reference Waveforms

- If a reference waveform is displayed and you set the measurement source of cursor measurement to Math1 to Math4, you can perform cursor measurement or automated measurement of waveform parameters on the reference waveform.
- If reference waveform Ref1 is displayed and you set the computation source waveform of Math2 to Math1, you can perform computation using reference waveform Ref1. The same holds true for Math1 and Math2 for Math3 and Math1 to Math3 for Math4.

Vertical Position (Position)

You can move the reference waveform vertical position within ± 4 divisions.



-
- In computation where the time axis is different between the reference waveform and input waveform, the instrument interpolates or compresses the reference waveform data so that the number of data points for both waveforms is the same.
 - You cannot change the reference waveform time axis.
 - Reference waveforms whose record length is 25 Mpoints or less are backed up when they are loaded. However, if you turn on the instrument while holding down the RESET key, the settings are set to their factory defaults, and the reference waveforms are cleared.
 - To load a file that contains waveform data of multiple channels as a reference waveform, use Load to Channels on the menu for loading waveform data from files into channels, and then load a waveform as a reference waveform.
-

Operators (Operation)

The following operators are available.

- **S1+S2**: Adds the waveforms assigned to Source1 and Source2
- **S1-S2**: Subtracts the waveform assigned to Source2 from the waveform assigned to Source1
- **S1xS2**: Multiplies the waveforms assigned to Source1 and Source2
- **Filter(S1)**: Performs phase shifting, moving average, or noise rejection on the waveform assigned to Source1
- **Integ(S1)**: Integrates the waveform assigned to Source1
- **Count(S1)**: Counts the number of edges of the waveform assigned to Source1 or the number of phase changes between the two waveforms assigned to Source 1 and Source2.
- **User Define**: User-defined expression (optional)

Addition, Subtraction, and Multiplication (S1+S2, S1-S2, S1xS2)

Performs addition, subtraction, or multiplication on the two waveforms assigned to Source1 and Source2.

IIR Filter, Smoothing (Filter(S1))

Performs phase shifting or moving average on the waveform assigned to Source1 or applies an IIR filter to the waveform.

Selecting the Filter Type (Filter Setup)

Set the filter type to one of the settings below.

- **Delay**: Displays a phase-shifted waveform
- **Moving Avg**: Displays a waveform whose noise has been eliminated through moving averaging
- **IIR Lowpass or IIR Highpass**: Displays a waveform whose noise has been eliminated through an IIR filter

Phase Shifting (Delay)

Displays a waveform that has been phase-shifted by the specified amount of time.

- **Delay (Delay)**

Set the amount of time to shift the phase.

Selectable range: Time corresponding to ± 5 divisions

The resolution is 1/sample rate.



The specified delay is retained even if you change the TIME/DIV setting, unless the change causes the specified delay to exceed the amount of time corresponding to ± 5 divisions.

9 Computed and Reference Waveforms

Smoothing (Moving Avg)

The instrument averages the waveforms according to the following equation. Set the number of points to use for moving averaging.

$$X_n = \left(\sum_{i=n-N}^{n+N-1} x_i + \sum_{i=n-N+1}^{n+N} x_i \right) / (2N \times 2)$$

(when the weight is set to 2N)

- **Weighted Points (Weight)**

Set the number of points to use for moving averaging.
Selectable range: 2 to 128 in 2ⁿ steps

IIR Filter (IIR Lowpass/IIR Highpass)

Set the filter order and cutoff frequency for the low-pass filter or high-pass filter.

- IIR Lowpass: Rejects high-frequency noise
- IIR Highpass: Rejects low-frequency noise

- **Filter order (Order)**

Select 1st order or 2nd order. Depending on the filter type and filter order that you select, the phase change varies as follows:

Filter Type	Harmonic Order	Phase Change
Low Pass	1	Phase lag
High Pass	1	Phase lead
High Pass/Low Pass	2	No phase change

- **Cutoff frequency (Cutoff1)**

You can set the cutoff frequency to a value up to 500 MHz.



- In the filter calculation (IIR filter), because the initial value is indeterminate, correct calculation is not possible immediately after the start of calculation. With a first-order filter the left end of the waveform is not shown, and with a second-order filter, both ends of the waveform are not shown.
 - The lower cutoff frequency limit varies depending on the time-axis setting.
-

Integration (Integ(S1))

Integrates the waveform assigned to Source1.

The instrument integrates with the initial point (Initial Point) set to zero.

Edge Count or Rotary Count (Count(S1))

The instrument counts edges or rotations of the waveforms assigned to Source1 and Source2.

Count Setup (Count Setup)

Count Type (Type)

Select the count type from one of the settings below.

- Edge: Counts the number of edges of one waveform
- Rotary: Counts the number of phase changes between two waveforms

Edge Count (Edge)

With the computation initial point (Initial Point) counted as zero, the instrument counts the number of times the waveform specified as Source1 passes through the detection level.



- **Detection Level (Threshold)**

Set the level for detecting edges.

Selectable range: ± 10 div

- **Polarity (Slope)**

Select which waveform slope the instrument will detect edges on.

	Detected when the waveform slope is rising
	Detected when the waveform slope is falling

- **Hysteresis (Hysteresis)**

You can apply a hysteresis to the detection level so that edges are not detected on small changes.

Selectable range: 0.3 div to 8.0 div

Resolution: 0.1 div

Rotary Count (Rotary)

The counter is incremented or decremented based on the phase changes in the waveforms assigned to Source1 (phase A) and Source2 (phase B). The state when the waveform is above the specified threshold level is considered to be 1. The state when the waveform is below the threshold level is considered to be 0. Depending on how phase A and phase B change, the counter is incremented or decremented.

The instrument counts the number of phase changes with the initial point (Initial Point) set to zero. In addition, the counter can be reset using the waveform specified with Source3 (Z phase).*

* Selectable only on the 4-channel model.

- **Relationship between State Transitions and Counting**

As shown in the figure below, the instrument counts up or counts down depending on the phase change (change in state between 0 and 1) of phase A and phase B.

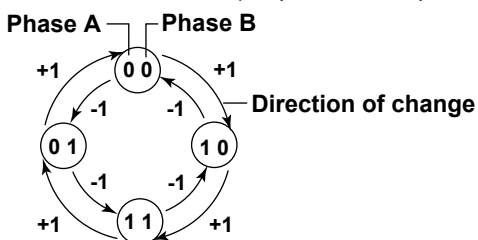

Counting Example

Source3 (phase Z): None

Source3 (phase Z): CH1, 

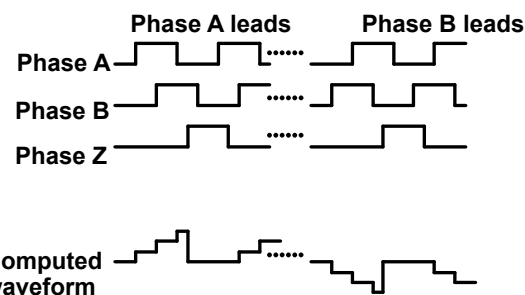
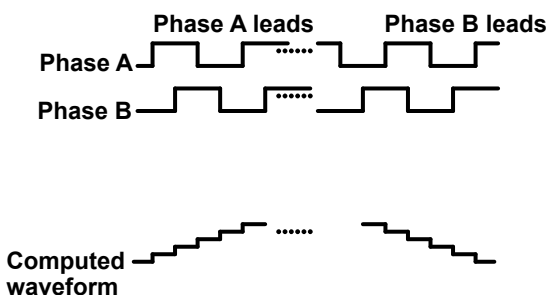



9 Computed and Reference Waveforms

- **Computation Source Waveform (Source1 (A), Source2 (B), Source3 (Z))**

The options are the same as were described above for the [computation source waveform](#) (Source1, Source2). You can select None (no setting) for only Source3 (Z).

Polarity (Polarity)

Select the Source3 (Z) polarity. You can set this when Source 3 (Z) is not set to None.

	Resets the counter when the signal level is high
	Resets the counter when the signal level is low

- **Determination Level (Threshold)**

Set the level for determining changes in the waveform states. Set the level for phase A, phase B, and phase Z. Selectable range: ± 10 div

- **Hysteresis (Hysteresis)**

Set a width to the level for determining changes in the waveform states so that the instrument does not perform determination on small fluctuations in the phase.

Selectable range: 0.3 div to 8.0 div

Resolution: 0.1 div

Initial Point (Initial Point)

Set the initial point when integrating, counting edges, or counting rotations. The instrument integrates and counts by assuming the initial point to be zero.

You can set the initial point numerically or set it to a specific point such as the trigger position or 0 divisions.

Selectable range: -5.00 div to 5.00 div

Resolution: 0.01 div

Setting a Specific Point (Set to)

You can set the initial point to any of the following points.

Trigger Pos (trigger position), -5.00 divisions, 0 divisions, Zoom1 (the center of Zoom1), or Zoom2 (the center of Zoom2)



When phase Z is used in a rotary count (Source 3 (Z) is CH1 to CH4), the initial point is fixed at -5.00 divisions and does not appear in the setup menu.

Setting Labels and Units (Label/Unit)

Turning Label Display On and Off (Display)

- ON: Shows labels
- OFF: Hides labels

Label (Name)

You can set Math1 to Math4 or Ref1 to Ref4 labels that appear when the label display is turned on. You can use up to eight characters for labels. The labels that you create are displayed on the screen.

Unit (Unit)

If the computation mode is Math1 to Math4, you can assign a unit to computation results.

- **Auto**

The default unit is used. The unit varies depending on the computation.

Filter, addition, subtraction, multiplication, or division	V, A, VV, AA, VA
Integration	Vs, As, VVs, AAs, VAs
Edge count or rotary count	Blank
User-defined computation	EU

- **User Define**

You can assign a unit using up to four characters.

Scaling (Ranging)

Select the method used to set the vertical display range of computed waveforms. You cannot set the method when the source waveform is Ref1 or Ref4.

When using user-defined computation (optional), the method is set to Auto.

Auto (Auto Scaling)

From the computed waveform, the instrument automatically determines the sensitivity (Sensitivity)² and the level¹ at the vertical center (Center) of the screen area.

Manual (Manual Scaling)

Set the sensitivity (Sensitivity)² and the level¹ at the vertical center (Center) of the screen area.

- 1 Voltage for a voltage waveform.
- 2 Voltage per division for a voltage waveform.



If you change the operator during manual scaling, the instrument changes the display range to the auto display range that corresponds to the new operator. Ranging remains set to Manual.

User-Defined Computation (User Define, Option)

You can define four original expressions.

User-defined computation can be used only on the 4-channel model.

Expression (Expression)

Define an expression by combining computation source waveforms and operators.

You can enter up to 128 characters.

Computation Source Waveform

The following waveform data can be used.

Menu Item	Description
C1 to C4	CH1 to CH4 waveforms
M1	Math1 waveform (can be used in Math2, Math3, and Math4)
M2	Math2 waveform (can be used in Math3 and Math4)
M3	Math3 waveform (can be used in Math4)
Bus	Can be used only with the DA operator.
T	Amount of time elapsed from the screen's left edge

9 Computed and Reference Waveforms

Operators

You can combine the following operators to define expressions.

Menu Item	Example	Description
Basic functions		
+, -, *, /	C1+C2-C3	Basic arithmetic of the input value
ABS	ABS(C1)	Absolute value of the input value
SQRT	SQRT(C2)	Square root of the input value
LOG	LOG(C1)	Logarithm of the input value
LN	LN(C1)	Natural logarithm of the input value
EXP	EXP(C1)	Exponent of the input value
P2	P2(C1)	Square of the input value
-	-(C1)	Inversion of the input value around level 0
Trigonometric functions		
SIN	SIN(C1)	Sine of the input value
ASIN	ASIN(C1)	Arc sine of the input value
COS	COS(C1)	Cosine of the input value
ACOS	ACOS(C1)	Arc cosine of the input value
TAN	TAN(C1)	Tangent of the input value
ATAN	ATAN(C1)	Arc tangent of the input value
PH	PH(C1,C2)	Phase difference between two input values
Differentiation and integration		
DIFF	DIFF(C1)	Derivative of the input waveform
INTEG	INTEG(C1)	Integral of the input waveform
Filter functions		
FILT1	FILT1(C1)	Application of a digital filter to the input waveform
FILT2	FILT2(C1)	Application of a digital filter to the input waveform
HLBT	HLBT(C1)	Hilbert function of the input waveform
MEAN	MEAN(C1,10)	Moving average of the input waveform
DELAY	DELAY(C1,0.001)	Phase shifting of the input waveform
BIN	BIN(CH1,1,-1)	Conversion of the input waveform into binary values
Pulse width functions		
PWHH	PWHH(C1,1,-1)	Pulse width computation of the input waveform from a rising edge to the next rising edge
PWHL	PWHL(C1,1,-1)	Pulse width computation of the input waveform from a rising edge to the next falling edge
PWLH	PWLH(C1,1,-1)	Pulse width computation of the input waveform from a falling edge to the next rising edge
PWLL	PWLL(C1,1,-1)	Pulse width computation of the input waveform from a falling edge to the next falling edge
PWXX	PWXX(C1,1,-1)	Pulse width computation of the input waveform from one rising or falling edge to the next rising or falling edge
FV	FV(C1,1,-1)	Inverse of the computed pulse width PWHH
DUTYH	DUTYH(C1,1,-1)	Duty ratio of the high side of each period of the input waveform
DUTYL	DUTYL(C1,1,-1)	Duty ratio of the low side of each period the input waveform
D/A conversion		
DA	DA(C4)	D/A conversion of a logic waveform

Constant

Menu Item	Description
K1 to K4	Constant
0 to 9	–
Exp	Exponent Used to enter a number in scientific notation in expressions (1E+3 = 1000, 2.5E–3 = 0.0025) Displayed as “E” in expressions to distinguish this from the “EXP” operator.
PI	Pi (π)
e	Euler’s constant (Napier’s constant) Base of the natural logarithm ($e = 2.71828\dots$) Displayed as “eul” in expressions to distinguish this from the “E” that represents exponents.
fs	Sample rate The value changes according to the changes in the time axis or record length setting.
1/fs	Number of samples per second Computed based on the instrument sample rate when the computation was executed. The value changes according to the changes in the time axis or record length setting.
Measure	A waveform parameter value can be used. Example: P.Max(C1)

Automated Measurement Values of Waveform Parameters (Measure)

You can use the automated measurement values of waveform parameters in expressions.

- “P.” precedes waveform parameters when waveform parameters are displayed in expressions.
- The instrument cannot retrieve waveform parameter values when the measurement source waveform display is off.



D/A conversion can be specified only when the computation source waveform is Bus. The computation result will be the same as the bus display (Hex) value.

Computation Conditions (Setup)

Configure constants (K1 to K4) and the digital filter, and turn computation averaging on or off.

Constant Definitions (Const Setup)

Set a value for K1 to K4.

Selectable range: $-10E+30$ to $10E+30$

Digital Filter Definitions (Filter1/Filter2)

When using FILT1 or FILT2 in user-defined computation, set the digital filter’s filter type, frequency band, and cutoff frequency.

- **Filter Type (Type)**

Select the filter from one of the settings below.

- IIR: Non-linear phase. Achieves adequate cutoff characteristics even at relatively low orders.
- FIR: Linear phase. Takes longer than IIR to process.

IIR (low pass; 10% cutoff)

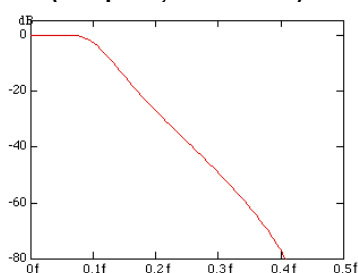

FIR (low pass; 10% cutoff)

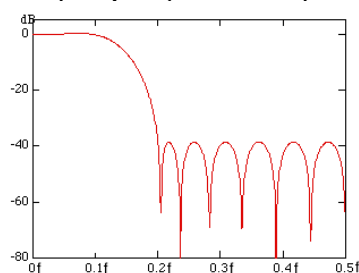

9 Computed and Reference Waveforms

- **Frequency Band (Band)**

You can set the frequency band to one of the settings below.

- LowPass
- HighPass
- BandPass

- **Cutoff frequency (Cutoff1/Cutoff2)**

Set for Filter1 and Filter2 separately.

Selectable range: 2.0% to 30.0% of the sampling frequency

Resolution: 0.2% of the sampling frequency

- **Averaging on Computation (Average)**

Set whether or not to linearly average the user-defined computation data. This setting applies to Math1 to Math4.

- ON: Averages computed data
- OFF: Does not average computed data

- **Average Count (Average Count)**

Selectable range: 2 to 1024 in 2^n steps



- If you change the computation conditions while averaging on computation is on, the computed data up to that point is cleared.
 - Averaging on computation cannot be used if the trigger mode is set to N SINGLE.
 - You cannot average computations during waveform acquisition.
 - You cannot average computations that are recomputed after waveform acquisition.
-

Auto Scaling (Auto Ranging)

Executes auto scaling. Use this feature when the computed waveform amplitude changes greatly and it is difficult to view the waveform.

You can also set the display range by specifying the vertical center (Center) of the display area and the value per division (Sensitivity).

Computation on History Waveforms (Math on History)

This feature performs computation on all history waveforms.

If waveform acquisition is stopped and you press the Math on History soft key, the instrument performs user-defined computation on all of the source channel's history waveforms.



- You cannot execute computation on history waveforms during waveform acquisition.
 - While computation on history waveforms is in progress, the "computing" icon and a progress bar appear at the top of the screen. All operations except for that of the Abort soft key are invalid.
 - If you set the trigger mode to N Single and start waveform acquisition, the instrument performs user-defined computation on the last waveform after waveform acquisition stops. To perform user-defined computation on all history waveforms, execute computation on history waveforms.
 - If you change a setting that would affect the result of user-defined computation, the instrument only recomputes on the selected history waveform.
 - If an error occurs in the average display or statistical processing of a history waveform, execute computation on history waveforms.
-

Examples of Expressions

For each operator, correct expressions and easily mistaken expressions are listed. Incorrect examples are shaded.

DIFF and INTEG (differentiation and integration) Examples

Syntax: DIFF(parameter), INTEG(parameters)

Parameter: Enter a waveform or an expression that contains waveforms.

DIFF(C1/3)	Derivative of the C1/3 waveform
INTEG(INTEG(C3))	Double integral of the C3 waveform
DIFF(DIFF(C4))	Double derivative of the C4 waveform
DIFF(5)	Not allowed because the parameter is a constant
INTEG(K1+10)	Not allowed because the parameter is a constant expression

FILT1 and FILT2 (Digital Filter) Examples

Syntax: FILT1(parameter), FILT2(parameter)

Parameter: Enter a waveform or an expression that contains waveforms.

FILT1(C1+C2)	Digital filtering of the C1+C2 waveform
FILT1(C3+K1)	Digital filtering of the C1+K1 waveform
FILT1(5)	Not allowed because the parameter is a constant
FILT2(K1+10)	Not allowed because the parameter is a constant expression

* The digital filters must be defined.

▶ [See here.](#)

MEAN (Moving Average) Examples

Syntax: MEAN(parameter 1, parameter 2)

Parameter 1: Set the source waveform of the moving average. Enter a waveform or an expression that contains waveforms.

Parameter 2: Set the moving average coefficient. Enter a constant or a constant expression.

MEAN(C1,10)	Moving average of waveform C1 with the coefficient set to 10
MEAN(C2+C3,K1)	Moving average of the C2+C3 waveform with the coefficient set to K1
MEAN(5,10)	Not allowed because parameter 1 is not a waveform or an expression that contains waveforms
MEAN(C1,C2)	Not allowed because parameter 2 is not a constant or a constant expression

DELAY (Phase Shift) Examples

Syntax: DELAY(parameter 1, parameter 2)

Parameter 1: Set the waveform to phase-shift. Enter a single-term waveform.

Parameter 2: Set the amount of phase shift. Enter a constant or a constant expression.

DELAY(C1,5E-3)	Phase-shift waveform C1 by 0.005 s
DELAY(C2,P.Period(C2)*2)	Phase-shift waveform C2 by 2 periods of waveform C2
DELAY(C1,C2)	Not allowed because parameter 2 is not a constant or a constant expression
DELAY(C1+C2,5)	Not allowed because parameter 1 is not a single-term waveform

9 Computed and Reference Waveforms

BIN (Conversion into Binary Values) Examples

Syntax: BIN(parameter 1, parameter 2, parameter 3)

Parameter 1: Set the waveform to convert into binary values. Enter a waveform or an expression that contains waveforms.

Parameter 2: Set the upper threshold level. Enter a constant or a constant expression.

Parameter 3: Set the lower threshold level. Enter a constant or a constant expression.

BIN(C1+C2,10+K1/2,10-K1/2)	Convert the C1+C2 waveform into binary values with Upper set to 10+K1/2 and Lower set to 10-K1/2
BIN(C2,P.High(C2),P.Low(C2))	Convert waveform C2 into binary values with Upper set to waveform C2's high value and Lower set to waveform C2's low value
BIN(5,10,2)	Not allowed because parameter 1 is not a waveform or an expression that contains waveforms
BIN(C1,C2,-1)	Not allowed because parameter 2 is not a constant or a constant expression

PWHH to DUTYL (Pulse Width Computation) Examples

Syntax: PWHH(parameter 1, parameter 2, parameter 3)

Parameter 1: Set the waveform to compute the pulse width of. Enter a single-term waveform.

Parameter 2: Set the upper threshold level. Enter a constant or a constant expression.

Parameter 3: Set the lower threshold level. Enter a constant or a constant expression.

PWHH(C1,K1,K2)	Compute the pulse width of waveform C1 with Upper set to K1 and Lower set to K2
DUTYL(C2,P.High(C2),P.Low(C2))	Compute the pulse width of waveform C2 with Upper set to waveform C2's high value and Lower set to waveform C2's low value
PWHH(5,10,2)	Not allowed because parameter 1 is not a waveform
PWHL(C1,C2,-1)	Not allowed because parameter 2 is not a constant or a constant expression
PWLL(C1+C2,1,-1)	Not allowed because parameter 1 is not a single-term waveform

DA (D/A Conversion) Examples

Syntax: DA(parameter 1)

Parameter 1: Set the source waveform for DA computation. This can be set only for C4. This can be executed only when the LOGIC menu key is illuminated.

DA(C4)	D/A conversion of a logic waveform
--------	------------------------------------

Examples of Other Operators

Syntax: Operator(parameter)

Parameter: Specify a waveform, a constant, or an expression.

SIN(PI)	Example in which the parameter is set to a constant
COS(C1)	Example in which the parameter is set to a waveform
ABS(C1+C2*2)	Example in which the parameter is set to an expression that consists of waveforms and a constant
SQRT(ABS(C1+C2*2))	Example in which the parameter is set to an expression
SIN(2*PI*T*K1)	Example in which the parameters is set to an expression (that consists of elapsed time T and constants)

Combinations of Operators That Are Not Allowed

You cannot enter M2 (Math2) in the expression of Math1.

Example: Math1=M2+C3

An expression can only contain up to two FILT1 or FILT2 functions.

Example: FILT1(C1)+FILT1(C2)+FILT1(C3)

Computation cannot be performed on a computed pulse width.

Example: PWHH(C1, 1, 0)+C2

When converting to binary values or when computing pulse width, the source waveform can only be a single waveform.

Example: BIN(C1-C2, 1, -1), PWHH(C1*C2, 0, 0)



-
- Averaging cannot be performed on pulse width computation.
 - If you want to convert the result of a computation such as C1+C2 to binary values or perform pulse width computation on it, define the Math1 and Math2 expressions in this manner: Math1 = C1+C2 and Math2 = BIN(M1, 0, 0).
-

10 FFT

The instrument can determine up to two input waveform power spectra (FFT1 and FFT2).* On models with the user-defined feature (option), the instrument can determine the linear spectrum, rms power spectrum, power spectrum, cross spectrum, transfer function, and coherence function.

FFT waveforms appear in the FFT window.

* Only FFT1 on the 2-channel model.

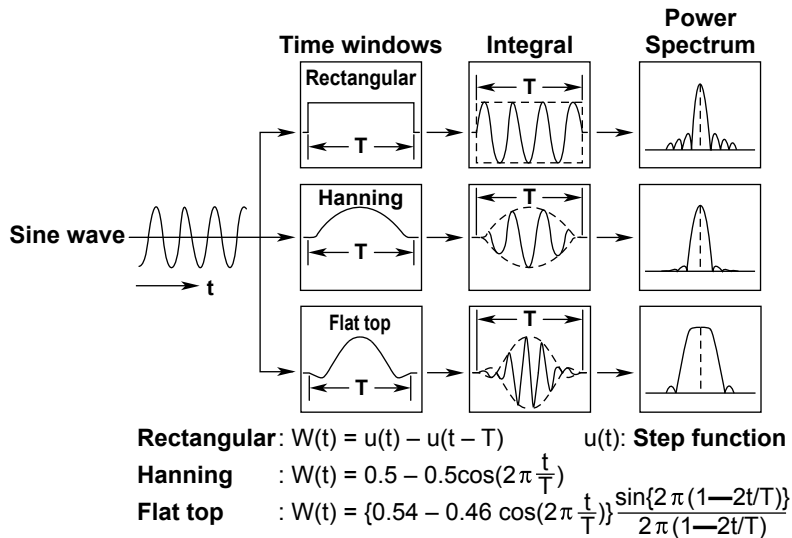

Turning the FFT On or Off (Display)

Set whether or not to perform FFT analysis. If you set this to ON, the FFT window appears.

- ON: Performs FFT analysis
- OFF: Does not perform FFT analysis

Analysis Source Waveform (Trace)

You can select from one of the settings below. The available settings vary depending on the model.

CH1 to CH4, Math1 to Math4

FFT Conditions (FFT Setup)

Configure the time window and how to display FFT waveforms (normal, peak hold, or average).

On models with user-defined computation (option), you can also select the spectrum to analyze.

Spectrum Type (Type/Sub Type)

On models with user-defined computation (option), you can also select the spectrum to analyze from the following:

Spectrum	Description	Unit (Default value)
LS-MAG	Amplitude of the linear spectrum of the specified waveform	Source unit
LS-LOGMAG	Logarithmic amplitude of the linear spectrum of the specified waveform	dB and source unit
LS-PHASE	Phase of the linear spectrum of the specified waveform	deg
LS-REAL	Real part of the linear spectrum of the specified waveform	Source unit
LS-IMAG	Imaginary part of the linear spectrum of the specified waveform	Source unit
RS-MAG	Rms power spectrum magnitude	Source unit
RS-LOGMAG	Rms power spectrum logarithmic magnitude	dB and source unit
PS-MAG	Amplitude of the power spectrum of the specified waveform	Enumeration of source units
PS-LOGMAG	Logarithmic amplitude of the power spectrum of the specified waveform	dB and source unit
PSD-MAG	Amplitude of the power spectrum density of the specified waveform	Enumeration of source units
PSD-LOGMAG	Logarithmic amplitude of the power spectrum density of the specified waveform	dB and source unit
CS-MAG	Magnitude of the cross spectrum of the specified two waveforms	Enumeration of source units
CS-LOGMAG	Logarithmic amplitude of the cross spectrum of the two specified waveforms	<ul style="list-style-type: none"> • If the source units are the same: dB and source unit • If the source units are different: dB
CS-PHASE	Phase of the cross spectrum of the two specified waveforms	deg
CS-REAL	Real part of the cross spectrum of the two specified waveforms	Enumeration of source units
CS-IMAG	Imaginary part of the cross spectrum of the two specified waveforms	Enumeration of source units
TF-MAG	Amplitude of the transfer function of the two specified waveforms	None
TF-LOGMAG	Logarithmic amplitude of the transfer function of the two specified waveforms	dB
TF-PHASE	Phase of the transfer function of the two specified waveforms	deg
TF-REAL	Real part of the transfer function of the two specified waveforms	None
TF-IMAG	Imaginary part of the transfer function of the two specified waveforms	None
CH-MAG	Amplitude of the coherence function of the two specified waveforms	None

Source unit: There is no source unit when the LinearScale unit or Math unit is not set.
 When the source unit is up to two characters in length, the source unit is used.
 When the source unit is more than two characters in length, "EU" is used.

Time Window (Window)

Set the time window to one of the settings below.

- Rectangle (rectangular window)
- Hanning (Hanning window)
- Flattop (flattop window)

Waveform Display Mode (Mode)

Select how to display FFT waveforms from one of the settings below.

- Normal: Displays FFT waveforms for each acquisition
- Max Hold: For each frequency, the instrument holds the maximum value among the values acquired from the start of analysis up to the current acquisition and displays it.
- Average: For each frequency, the instrument displays the average of the values acquired from the start of analysis up to the current point.

Analysis Source Waveform (Trace2)

When the spectrum type is CS, TF, or CH, you can choose from the following options.

CH1 to CH4, Math1 to Math4

Unit Setting (Unit)

Select the unit type from one of the settings below.

- AUTO: The default unit is used. The unit varies depending on the type spectrum.
- User Define: You can assign a unit (User Unit) using up to four characters.

Number of FFT Points (FFT Point)

You can select from one of the settings below.

1.25 k, 2.5 k, 12.5 k, 25 k, 125 k, 250 k, 1.25 M

**Relationship between the Number of FFT Points and Number of Displayed Points (Display Record Length)**

Depending on the number of displayed points in the window that you select using the analysis range (Time Range) setting, the actual number of FFT points may be different from the number of FFT points that you selected.

- If the number of FFT points is less than the number of displayed points, the displayed points are sampled to match the number of FFT points.
The FFT may not cover the entire display range.
- If the number of FFT points is greater than the number of displayed points, the number of FFT points is adjusted to an appropriate number less than or equal to the number of displayed points.

Analysis Range (Time Range)

Set the analysis range to any of the following windows below.

- Main: Entire main window
- Zoom1: Entire Zoom1 window
- Zoom2: Entire Zoom2 window

Scale Value (Display Setup)

Set the vertical and horizontal scale values.

Vertical Scale (Vert.Scale)1

You can select from one of the settings below.

- Auto: Sets the vertical scale values automatically
- Manual: For manually setting the center (Center) of the vertical axis and the value per division (Sensitivity)

Horizontal Scale (Horiz.Scale)

You can select from one of the settings below.

- Auto: Sets the center point and span automatically
- Center/Span: You must set the center point and span manually
- Left/Right: You must set the left and right ends of the scale manually

Displaying the Source Waveform (VT Display)

Select whether or not to display the FFT source waveform.

- ON: Displays the source waveform
- OFF: Does not display the source waveform

Cursor Measurement (Measure Setup)

You can analyze values on an FFT waveform using marker cursors and peak cursors.

Cursor Type (Mode)

Set the cursor that you want to use for analyzing to one of the settings below.

- OFF: Disables cursor measurement.
- Marker: Using two marker cursors, you can display frequencies, levels, and the difference between the markers.
- Peak: Using the detection level and excursion, you can display frequencies and levels.

Marker Cursor (Marker)

The instrument displays the frequencies and levels at the two marker cursors (Marker1 and Marker2). It can also display the difference between the cursors. Marker cursors move on the waveform data points.

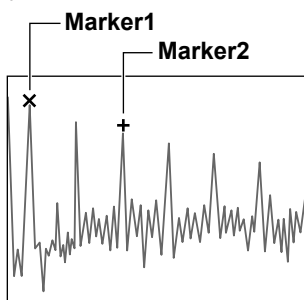

- **Measurement Item (Item)**

Set the measurement item to one of the settings below.

F1: Displays the Marker1 frequency

F2: Displays the Marker2 frequency

ΔF : Displays the frequency difference between Marker1 and Marker2

V1: Displays the Marker1 level

V2: Displays the Marker2 level

ΔV : Displays the level difference between Marker1 and Marker2

- **Marker Cursor Positions (Marker1/Marker2)**

Set the Marker1 and Marker2 positions.

Selectable range: ± 5.00 div

Peak Cursors (Peak)

Using the threshold value (Threshold) and the difference between peak and valley (Excursion), the instrument determines the frequency (Frequency) and level (Peak). Only the peaks that meet the threshold and excursion conditions are displayed.

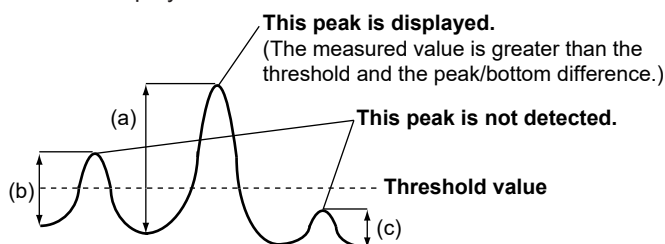

- (a) Peak/bottom difference < measured value
- (b) Peak/bottom difference > measured value
- (c) Peak/bottom difference > measured value

- **Threshold (Threshold)**

Set the threshold value for detecting peaks. Peaks that are greater than the specified values are measured.

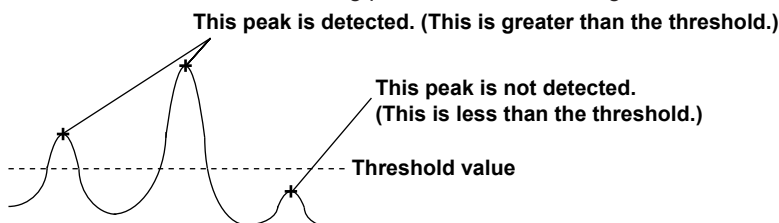

- **Difference between peak and valley (excursion)**

Peaks whose amount of change from the peak value (the difference between the peak and valley) is greater than the specified value are measured.

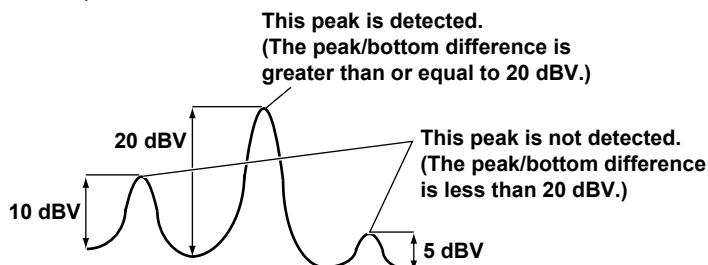

Example: Excursion = 20 dBV

- **List Display (List)**

The list displays the following items. You can also jump to the maximum level (Jump To Max Peak).

No.	Analysis number. Analysis results can be displayed in the range of 1 to 10.
Frequency	Displays the peak frequency
Peak	Displays the peak level

- **Analysis Number (List No.)**

The instrument moves to the selected number and displays the frequency and level.

11 Cursor Measurement

You can move cursors on the waveforms displayed on the screen to view the measured values at the points where the cursors intersect the waveforms.

ΔT & ΔV cursor

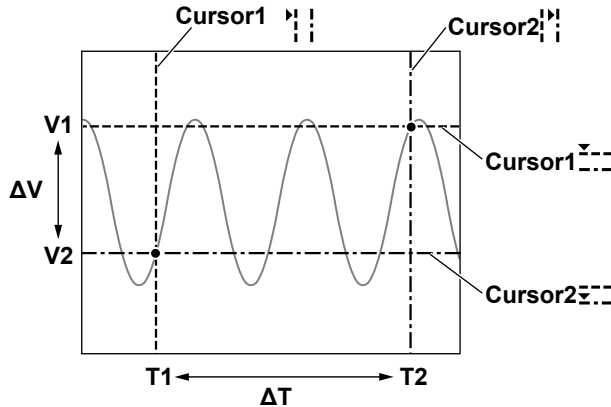

Turning Cursor Measurement On and Off (Display)

Sets whether or not to make measurements using cursors.

- OFF: Turns cursor measurement off
- ON: Turns cursor measurement on

Cursor Mode (Type)

There are five cursor modes.

- **ΔT cursors:** Two ΔT cursors are used to measure time values.
- **ΔV cursors:** Two ΔV cursors are used to measure vertical values.
- **ΔT & ΔV cursors:** Two ΔT cursors and two ΔV cursors are used to measure time-axis and vertical values.
- **Marker cursors (Marker):** Four marker cursors that move on the waveform are used to measure waveform values.
- **Angle cursors (Degree):** Two angle cursors are used to measure angles.

Measurement Source Waveform (Trace)

Set the measurement source waveform to one of the waveforms below. The available settings vary depending on the model.

CH1 to CH4/LOGIC,^{1,2} Math1 to Math4, All³

- 1 Select the CH4 or LOGIC key to choose the waveform you want to perform cursor measurement on. The selected waveform's key illuminates.
- 2 If the source waveform is a logic signal (LOGIC), you can only use the ΔT cursors, ΔT & ΔV cursors, and angle cursors.
- 3 "All" specifies all channels. This setting is only available for ΔT cursors and angle cursors.



- Even when a waveform is selected as a measurement source waveform, if the source waveform is not displayed on the screen (the corresponding key is not illuminated), vertical cursor measurements are not performed.
- You cannot perform cursor measurement on snapshot waveforms or accumulated waveforms that have been acquired in the past. You can perform cursor measurement on the most recent accumulated waveform.
- For history waveforms, cursor measurement is performed on the waveform whose record number is selected.

ΔT Cursors (ΔT)

The ΔT cursors are two lines that are perpendicular to the time axis. You can use them to measure the time from the trigger position to each of the ΔT cursors, the time difference between the two cursors, and the inverse of the time difference between the two cursors. Cursor1 is a dashed line, and Cursor2 is a dot-dash line. You can also measure the vertical values at the points where the ΔT cursors intersect the waveforms.

Measurement Items (Item Setup)

You can measure the following time values at the cursor positions.

T1	Time value at Cursor1
T2	Time value at Cursor2
ΔT	Difference between the time values of Cursor1 and Cursor2
1/ ΔT	Inverse of the time difference between Cursor1 and Cursor2
V1	Vertical values at the points where Cursor1 intersects the waveforms*
V2	Vertical values at the points where Cursor2 intersects the waveforms*
ΔV	Difference in the vertical values at the points where Cursor1 and Cursor2 intersect the waveforms*

* If you set the measurement source waveform to All, values of all the measurement items are measured for CH1 through CH4 (LOGIC) and Math1 to Math4.

Example of Logic Signal Measurement

The instrument displays measured values according to the format (Format) and bit order (Bit Order) settings in the LOGIC menu.

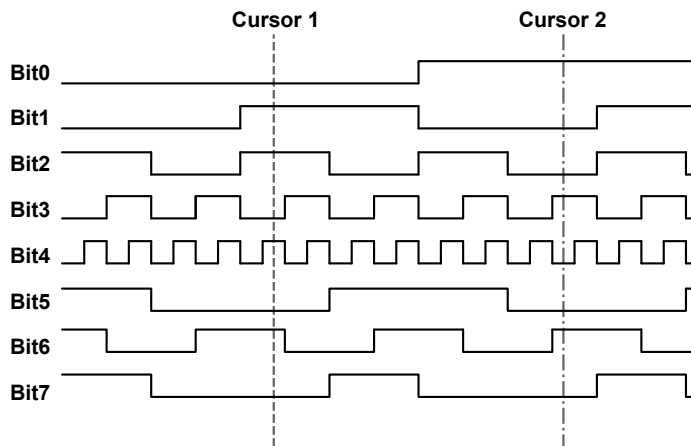

Measurement example when Format is set to Hex and the Bit Order is from Bit7 to Bit0
V1(LOGIC) 6A V2(LOGIC) 92

ΔV Cursors (ΔV)

The ΔV cursors are two lines that are perpendicular to the vertical axis. You can use them to measure vertical values at the cursor positions. You can also measure the level difference between the two cursors. Cursor1 is a dashed line, and Cursor2 is a dot-dash line.

Measurement Items (Item Setup)

You can measure the following vertical values at the cursor positions.

V1	Vertical value at Cursor1
V2	Vertical value at Cursor2
ΔV	Difference in the vertical values at Cursor1 and Cursor2

ΔT & ΔV Cursors (ΔT & ΔV)

ΔT cursors and ΔV cursors are displayed at the same time.

Measurement Items (Item Setup)

You can measure the following time and vertical values at the cursor positions.

Time axis	
T1	Time value at Cursor1
T2	Time value at Cursor2
ΔT	Difference between the time values of Cursor1 and Cursor2
$1/\Delta T$	Inverse of the time difference between Cursor1 and Cursor2
Vertical axis	
V1	Vertical value at Cursor1
V2	Vertical value at Cursor2
ΔV	Difference in the vertical values at Cursor1 and Cursor2

Marker Cursors (Marker)

Four markers are displayed on the selected waveform. You can measure the level at each marker, the amount of time from the trigger position to each marker, and the level and time differences between markers.

Marker Display Format (Marker Form)

Set the marker display format to one of the settings below.

- Mark: A dot
- Line: A crosshair

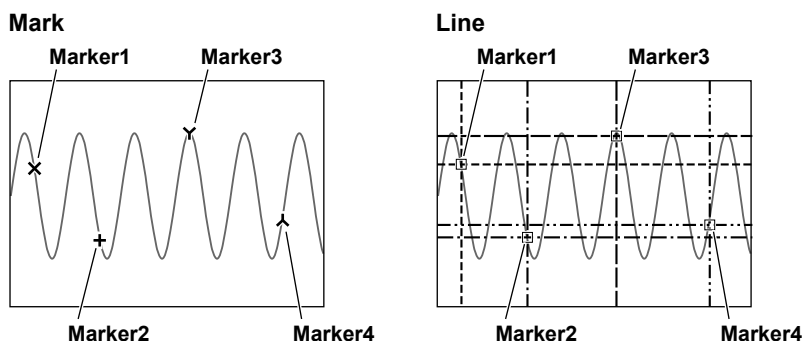

Markers (Marker1 through 4)

Enables or disables each of the markers. If you enable a marker, set the measurement source waveform and the measurement items.

You can assign each marker to separate waveforms.

- OFF: Disables the marker
- CH1 to CH4, Math1 to Math4: Sets the measurement source waveform

Measurement Items (Item Setup)

Marker cursors move on the waveform data. You can measure the following values at Marker1.

T1	Time value at Marker1
T1-T2	Difference between the time values of Marker1 and Marker2
T1-T3	Difference between the time values of Marker1 and Marker3
T1-T4	Difference between the time values of Marker1 and Marker4
V1	Vertical value at Marker1
V1-V2	Difference in the vertical values at Marker1 and Marker2
V1-V3	Difference in the vertical values at Marker1 and Marker3
V1-V4	Difference in the vertical values at Marker1 and Marker4

Angle Cursors (Degree)

You can measure time values and convert them to angles. On the time axis, set the zero point (Ref Cursor1 position), which will be the measurement reference, the end point (Ref Cursor2 position), and the reference angle that you want to assign to the difference between Ref Cursor1 and Ref Cursor2. Based on this reference angle, you can measure the angle between two angle cursors (Cursor1 and Cursor2).

Measurement Items (Item Setup)

The instrument measures the angle cursor (Cursor1 and Cursor2) positions as angles.

D1	Angle of Cursor1 from Ref Cursor1
D2	Angle of Cursor2 from Ref Cursor1
ΔD	Angle difference between Cursor1 and Cursor2
V1	Vertical values at the points where Cursor1 intersects the waveforms*
V2	Vertical values at the points where Cursor2 intersects the waveforms*
ΔV	Difference in the vertical values at the points where Cursor1 and Cursor2 intersect the waveforms*

* If you set the measurement source waveform to All, values of all the measurement items are measured for CH1 to CH4 (or LOGIC) and Math1 to Math4.

Reference Setup (Reference Setup)

Set the zero point (Ref Cursor1 position), which will be the measurement reference, the end point (Ref Cursor2 position), and the reference angle.

Reference Angle (Ref Value)

Set the reference angle you want to assign to the range defined by Ref Cursor1 and Ref Cursor2.

Selectable range: 1 to 720

Angle Unit (Unit)

You can set the angle unit using any characters you like.

Reference Cursors (Ref Cursor)

Set the zero point (Ref Cursor1) and the end point (Ref Cursor2).

Selectable range: -5.00 div to 5.00 div

Moving the Cursors (Cursor/Marker)

The cursor type determines the range of cursor movement.

- **ΔV and ΔV in ΔT & ΔV Mode (Cursor1 = and Cursor2 =)**

You can move these cursors in the range of -4 to +4 divisions from the vertical center of the window in 0.01-division steps.

- **ΔT , ΔT in ΔT & ΔV , Degree, Marker Cursors (Cursor1 II, Cursor2 II, Marker1 to 4)**

You can move these cursors in the range of -5 to +5 divisions from the horizontal center of the window in 0.01-division steps. If a zoom window is displayed and a cursor moves into the zoom window, you can move the cursor by 0.01 divisions of the zoom window at a time.

- **Linking Cursor1 and Cursor2**

When the cursor type is ΔT , ΔV , ΔT & ΔV , or Degree and you select Cursor1 and Cursor2 at the same time, you can move the cursors while maintaining the same space between them.



Notes about Cursor Measurement

- The measured time values are based on the trigger position.*
 - * If [delay cancel \(Delay Cancel\)](#) is set to OFF, they are based on the trigger point.
- The measured value for data that cannot be measured appears as "****."
- If the display record length is less than a given length (in the interpolation zone), the instrument interpolates between sampled data if Dot Connect is not set to OFF. Therefore, it is possible for there to be no sampled data where the vertical cursor is.

Because marker cursors move on the sampled data, you can always read sampled data.

Cursor Jumping (Cursor Jump/T Cursor Jump)

You can make Cursor1, Cursor2, or Marker1 to Marker4 jump to the center of the specified zoom window. The jump options are listed below.

When the cursor is ΔT , the $\Delta T \& \Delta V$ ΔT cursor, or Degree

Cursor1 to Zoom1: Cursor1 jumps to the Zoom1 window. Cursor1 to

Cursor1 to Zoom2: Cursor1 jumps to the Zoom2 window. Cursor1 to

Cursor2 to Zoom1: Cursor2 jumps to the Zoom1 window. Cursor1 to

Cursor2 to Zoom2: Cursor2 jumps to the Zoom2 window. Cursor1 to

For marker cursors

Jump to Zoom1: The selected marker jumps to the Zoom1 window.

Jump to Zoom2: The selected marker jumps to the Zoom2 window.

12 Automated Measurement of Waveform Parameters

For waveforms that are displayed on the screen, various measurement items (waveform parameters), such as maximum and minimum values, can be measured automatically and their statistics can be calculated. The enhanced parameter measurement feature allows you to automatically measure parameters in two areas (defined as area 1 and area 2) and perform various calculations on the automated measurement values of waveform parameters.

Turning Automated Measurement On or Off (Mode)

Enables or disables the automated measurement of waveform parameters.

- ON: Enables automated measurement
- OFF: Disables automated measurement

Source Waveform (Source)

Selects the automated measurement source waveform. The available settings vary depending on the model. CH1 to CH4/LOGIC (Bit0 to Bit7),* Math1 to Math4

* CH4 or LOGIC, whichever the corresponding key is illuminated, can be selected.



Measurements cannot be made on a snapshot waveform or an accumulated waveform that is not the most recent waveform.

Source Window (Time Range)

Selects the window on which to perform automated measurement of waveform parameters.

- Main: Main window
- Zoom1: Zoom1 window
- Zoom2: Zoom2 window

Measurement Time Period (T Range1/T Range2)

Sets the start point (T Range1) and the end point (T Range2) of the automated measurement time period.

Selectable range: ± 5 divisions from the center of the waveform area

Resolution: 0.01 div

Automated Measurement of Waveform Parameters

The instrument automatically measures the specified measurement items on the source waveform.

Measurement Items (Item Setup)

Sets the measurement items for each source waveform.

Up to a total of 100000 data values can be saved for the entire area and all sources (CH1 to CH4, Math1 to Math4, LOGIC*). The instrument can display up to 30 measurement items on the screen.

* You cannot select CH4 and LOGIC at the same time.

The source waveform type determines the measurement items that you can choose.

- **Analog Signal**

All voltage and time items

- **Logic Signal**

The following time measurement items

Freq, Period, Avg Freq, Duty, Pulse Count, Delay



- You can increase the number of displayed measurement item values using the number of rows (Max Rows) outside the waveform area in the system settings (System Configuration).
- You can read out the values of measurement items that are not displayed on the screen by using communication features.
- If you execute GO/NO-GO determination based on a waveform parameter, automated measurement turns on.
- If the power measurement mode of the power supply analysis feature (/G03 option) is turned on, you will not be able to set the following measurement items.
Max, Min, P-P, Rms, Mean, Sdev, Avg Freq

Voltage Measurement Items

V1: Voltage at the point where the trace intersects T Range1

V2: Voltage at the point where the trace intersects T Range2

Max: Maximum voltage [V]

Min: Minimum voltage [V]

P-P: P-P value (Max – Min) [V]

High: High voltage [V]

Low: Low voltage [V]

Amplitude: Amplitude (High – Low) [V]

Rms: Rms voltage [V] $(1/\sqrt{n})(\sum(xN^2))^{1/2}$

Mean: Mean voltage [V] $(1/n) \sum xN$

Sdev: Standard deviation [V] $((\sum xN^2 - (\sum xN)^2/n)/n)^{1/2}$

IntegTY+: Area under the positive parts [Vs]

IntegTY: Area under the positive parts – area under the negative parts [Vs]

+Over: Overshoot [%]

$$(\text{Max} - \text{High}) / (\text{High} - \text{Low}) \times 100$$

-Over: Undershoot [%]

$$(\text{Low} - \text{Min}) / (\text{High} - \text{Low}) \times 100$$

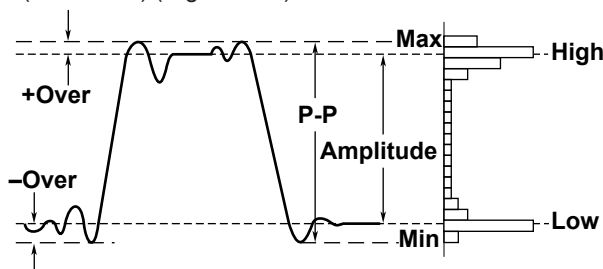



- The unit of measurement that is listed for voltage measurement items changes to amperes when current is measured. If you have specified a unit when measuring in linear-scaling mode, the instrument displays the measured values using the specified unit.
- You can determine the area of XY waveforms by using the analysis features available in the X-Y menu.

Time Measurement Items

ΔT : Time difference between T Range1 and T Range2

Freq: Frequency [Hz]

Period: Period [s]

+Width: Time span when the waveform is above the mesial reference line [s]

-Width: Time span when the waveform is below the mesial reference line [s]

Duty: Duty cycle ($+Width/Period \times 100$) [%]

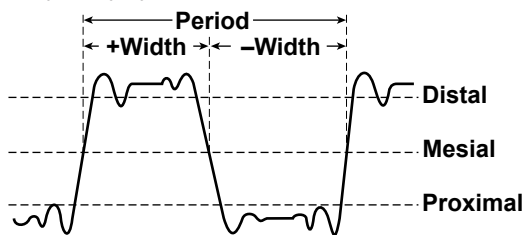

Rise: Rise time [s]

Fall: Fall time [s]

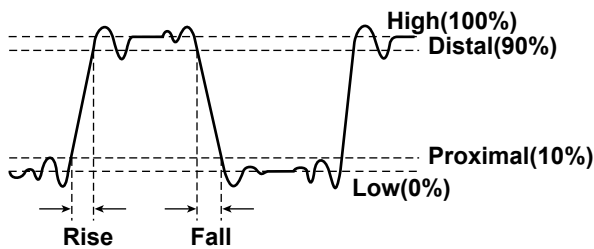

Delay: Delay between waveforms [s]

* Freq, Period, +Width, -Width, Rise, Fall, and Duty parameters are measured on the first period of the waveform.

Pulse Count: Pulse count [no unit]

Edge Count: Edge count [no unit]

Avg Freq: Average frequency in the time range [Hz]

Avg Period: Average period in the time range [s]

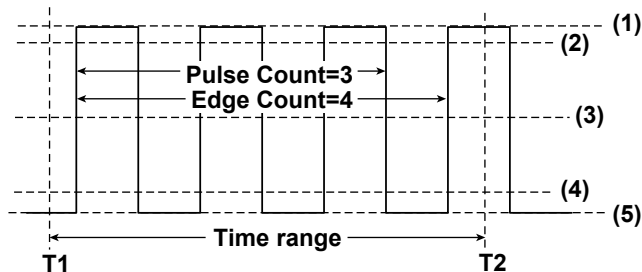

- (1) High
- (2) Distal
- (3) Mesial
- (4) Proximal
- (5) Low

12 Automated Measurement of Waveform Parameters

Burst: Burst period [s]

Set the measurement time period (Time Range) to a value appropriate for the burst period you want to measure.

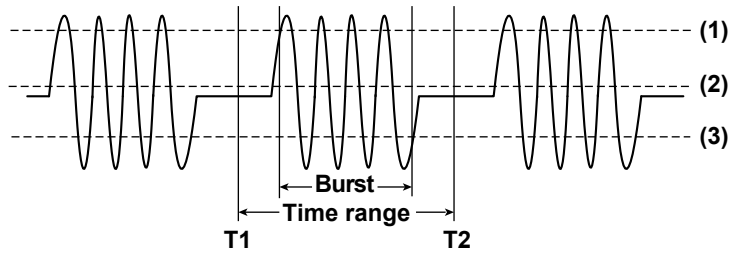

- (1) Distal
- (2) Mesial
- (3) Proximal

Measurement of Delay between Waveforms (Delay Setup)

Measures the time difference from the reference waveform (Reference) edge or the trigger position* to the source waveform (Source) edge.

* If **delay cancel (Delay Cancel)** is set to OFF, they are based on the trigger point.

- Reference: Selects the reference waveform (CH1 to CH4, Math1 to Math4, or Trigger Position)
- Polarity: Selects the slope (rising or falling) of the edge you want to detect
- Count: Sets which edge counted from the start point (T Range1) of the time range to use as a detected point (reference point or measured point). The selectable range is 1 to 10.
- Unit: Sets the unit for displaying the delay between waveforms to Time or Degree when Reference is not set to Trigger Position.

Time

Displays the delay between waveforms in time.

Degree

Displays the delay between waveforms as an angle.

Conversion formula: $\text{angle} = \text{delay (s)} / \text{period (s)} \times 360 \text{ (deg)}$ where the period is the period of the reference waveform.

Example

(When Reference is not set to Trigger Position)

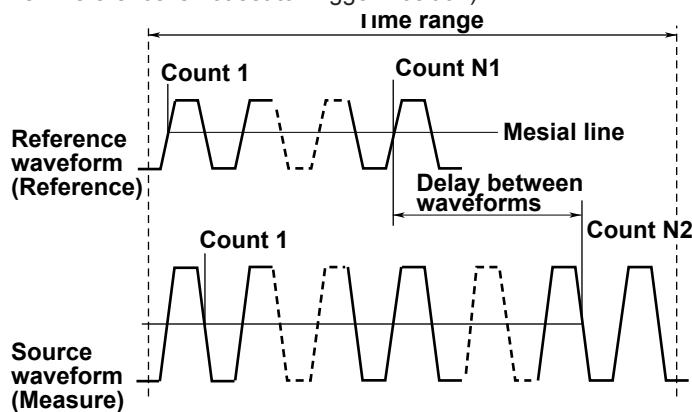

Reference waveform settings

- Polarity : \uparrow (rising)
- Count : N1 (an integer between 1 and 10)

Source waveform settings

- Polarity : \downarrow (falling)
- Count : N2 (an integer between 1 and 10)

Cycle Mode (Cycle Mode)

The time range for automated measurement is set to the period, not the time range specified by T Range1 and T Range2. You can set how the instrument determines the time range to one of the settings below.

1 Cycle: Sets the time range to the first period after T Range1

N Cycle: Sets the time range to the left end of the first period that is between T Range1 and T Range2 to the right end of the Nth period

OFF: Sets the time range to the duration between T Range1 and T Range2 (the same as normal automated measurement)

* The method of determining the period is the same as the method for determining the Period measurement item.

In cycle mode, the following items can be measured.

Max: Maximum voltage [V]

Min: Minimum voltage [V]

P-P: P-P value (Max - Min) [V]

High: High voltage [V]

Low: Low voltage [V]

Amplitude: Amplitude (High - Low) [V]

Rms: Rms voltage [V] $(1/\sqrt{n})(\sum(xN^2))^{1/2}$

Mean: Mean voltage [V] $(1/n) \sum xN$

Sdev: Standard deviation [V] $((\sum xN^2 - (\sum xN)^2/n)/n)^{1/2}$

IntegTY+: Area under the positive parts [Vs]

IntegTY: Area under the positive parts - area under the negative parts [Vs]

+Over: Overshoot [%] $(Max - High)/(High - Low) \times 100$

-Over: Undershoot [%] $(Low - Min)/(High - Low) \times 100$

Time range for each cycle mode

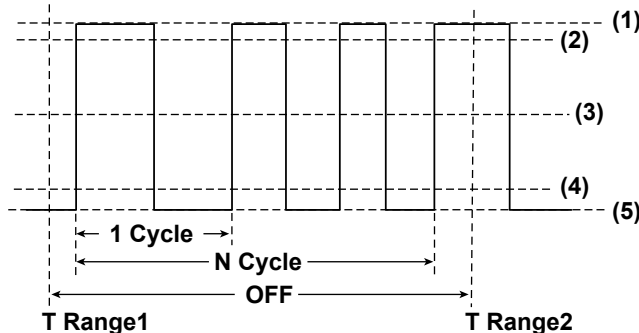

- (1) High
- (2) Distal
- (3) Mesial
- (4) Proximal
- (5) Low

Measurement Location Indicator (Indicator)

Indicates the measured location of a specified item using cursors. The measurement locations of the following items can be indicated.

Max, Min, P-P, High, Low, Amplitude, Rms, Mean, Sdev, +Over, -Over, V1, V2, IntegTY+, IntegTY, Avg Freq, Avg Period, Burst, Freq, Period, +Width, -Width, Duty, Rise, Fall, Delay

Rise

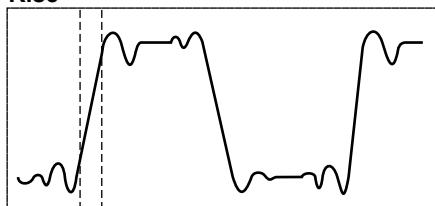

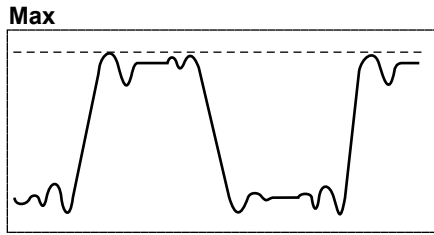

If the statistical processing mode is set to Cycle or History, the measurement location cannot be displayed.

Reference Level for Automated Measurement (Ref Levels)

Sets the reference level that is used to measure various parameter values such as High, Low, Hi-Low, Rise, and Fall for each source waveform.

Mode

Selects the unit used to set the reference level (Distal/Mesial/Proximal).

- **%**
Assuming the High and Low values to be 100% and 0%, respectively, you can set the distal, mesial, and proximal values to any percentage.
- **Unit**
You can set the distal, mesial, and proximal values to any voltage.

Distal, Mesial, and Proximal (Distal/Mesial/Proximal)

You can set the distal, mesial, and proximal values. If you set the reference level mode to Unit, specify values that are within the range of the voltage source waveform.

▶ [See here.](#)

How to Determine the High and Low Values

Selects how the instrument determines the 100% (High) and 0% (Low) levels of the measurement source.

- **Auto**
Sets the high value to the high amplitude level and the low value to the low amplitude level based on the voltage level frequency of the source waveform in the time range taking into account the effects from ringing, spikes, etc. This method is suitable for measuring square waves and pulse waves.
- **Max-Min**
Sets high and low values to the maximum and minimum values in the time range. This method is suitable for measuring sinusoidal and saw waves. It is not suitable for waveforms that have ringing and spikes.
- **Histogram**
Sets the levels of the two highest frequencies on a histogram to high and low. This method is suitable for waveforms whose maximum frequency of a given level is extremely high compared to frequencies of other levels, such as in a rectangular waveform.

Statistics (Statistics)

Display the following five statistics on the automated measurement values of waveform parameters. Statistics can be calculated on up to nine automatically measured items.

- Maximum (Max)
- Minimum (Min)
- Mean (Mean)
- Standard deviation (σ)
- The number of measured values used to calculate statistics (Count)

The following types of statistical processing are available.

- Normal statistical processing (Continuous)
- Statistical processing for each period (Cycle)
- Statistical processing of history waveforms (History)



If 10 or more automatically measured items are selected, the instrument displays the first 9 items in ascending order by channel number and in the order that the items appear in the automated measurement item selection menu (Max, Min, ..., +Over, -Over, ..., Freq, Period, ..., and Delay).

Example:

When CH1: Max, Min, High, Low, CH2: Max, Min, High, CH3: Max, Min, High are selected, the following items are displayed: CH1: Max, Min, High, Low, CH2: Max, Min, High, CH3: Max, and Min

You can view or load the statistics of other items in the following way.

- Increase the number of rows (Max Rows) outside the waveform area in the system settings (System Configuration) to show the items on the screen.
- Load the items into a PC using the communication feature.
- Save the statistical items as automated measurement values of waveform parameters, and load the data into a PC.

Statistical Processing Mode (Mode)

Set the statistical processing mode to one of the settings below.

- OFF: Disables statistical processing
- [Continuous](#): Normal statistical processing
- [Cycle](#): Statistical processing of measured values for each period (cyclic statistical processing)
- [History](#): Statistical processing of history waveforms

Normal Statistical Processing (Continuous)

While acquiring waveforms, the instrument calculates the statistics of the waveforms that it has acquired so far. The number of measured values used to calculate statistics (Count) is equal to the number of waveforms that have been acquired up to that point.

If you stop waveform acquisition and restart it, or if you add another automatically measured item during waveform acquisition, the Count value is reset to 1.

Restart (Restart)

Resets the statistics calculated up to that point. You can only use this feature when the mode is set to Continuous.

Statistical Processing Setting When the Trigger Level Changes (TrigLevelChange)

When the mode is set to Continuous, select whether statistical processing should be reset when the trigger level is changed during waveform acquisition.

- Restart: Count is reset to 1, and statistical processing restarts.
- Ignore: Statistical processing continues without being reset.

Cyclic Statistical Processing (Cycle)

In cyclic statistical processing, the instrument divides the displayed waveform by the period that it automatically determines through calculation, and calculates statistics of the measured values in each period. The method of determining the period is the same as the method for determining the Period measurement item.

This mode is effective for items, such as Rms or Avg, that may result in errors depending on the time range setting.

The following measurement items cannot be selected.

Avg Freq (average frequency), Avg Period (average period), Pulse Count (pulse count), Edge Count (edge count), Delta T, Delay

Cycle Trace (Cycle Trace)

Selects the source waveform used to determine the period.

- **Own**

The period is determined for each source waveform.

- **CH1 to CH4/LOGIC (Bit0 to Bit7),* Math1 to Math4**

The period is determined for the selected waveform, and that period is used on all source waveforms. If you select LOGIC, select the source bit.

* CH4 or LOGIC, whichever the corresponding key is illuminated, can be selected.

Example in Which Cycle Trace Is Set to CH2

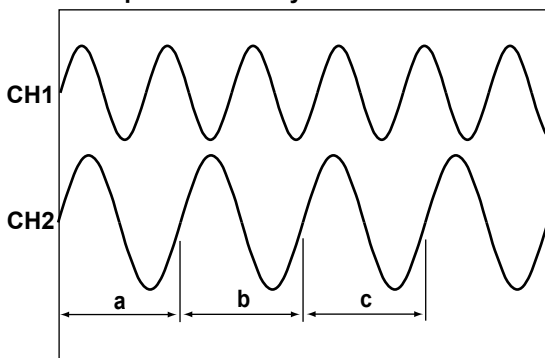

Measures the items in ranges a, b, and c, and calculates statistics on the items in the order a, b, and c.

The items of other channels are also measured in ranges a, b, and c. If you select Own, the items are measured automatically over each waveform's period.

Executing Statistical Processing (Exec)

Executes statistical processing. You can use this command when the statistical processing mode is set to Cycle or History.



- The number of cycles being used for the cyclic statistical processing is displayed in the statistical display's Count column.
- The number of cycles that can be used in cyclic statistical processing varies depending on the number of measured items that the instrument is calculating the statistics of.
 $100000 / (\text{the number of measured items that the instrument is calculating the statistics of})$
- Cyclic statistical processing is performed only on the main window.

Statistical Processing of History Waveforms (History)

The instrument automatically measures items on the selected range of the history waveform and calculates statistics. The instrument calculates statistics from the oldest waveform. The statistics of the waveforms displayed in Time Stamp are calculated.

Executing Statistical Processing (Exec)

Executes statistical processing. You can use this command when the statistical processing mode is set to Cycle or History.

List Display (List)

Displays a list of calculated statistics. You can display this list when the statistical processing mode is set to Cycle or History.

- **Search Mode**

Searches for the specified item and highlights the detected line.

OFF (disable), Statistics Max (maximum value), Statistics Min (minimum value), $a \leq \text{Data}$ (a value greater than or equal to the specified value), $\text{Data} \leq b$ (a value less than or equal to the specified value), $a \leq \text{Data} \leq b$ (a value between two specified values)

- **Jump (When Search Mode is set to OFF)**

Jumps to and highlights the specified destination.

Statistics Max (maximum value), Statistics Min (minimum value), Oldest, or Latest

- **Jump to Search Point (When Search Mode is not set to OFF)**

Jumps to and highlights the specified destination. You can specify any of the search results.

If multiple maximum and minimum values are available, the data with the newest number is highlighted.

Previous (previous data), Next (next data), Oldest, or Latest

- **Sort**

Sorts the list in the specified order.

Forward (from the oldest) or Reverse (from the latest)



-
- You can also use the jog shuttle to specify the highlighted measured value.
 - In cyclic statistical processing, you can highlight a measured value to display one period of the corresponding waveform on the zoom display.
 - In statistical processing of history data, you can highlight a measured value to display the corresponding waveform.
-

Trend Display and Histogram Display (Trend/Histogram)

You can display up to two trends or histograms* of the specified measurement items. You can also display values using the measurement feature. Mean, standard deviation, and other statistics can be displayed on the histogram display.

* Only 1 on 2-channel models

Display Example (Item = P-P)

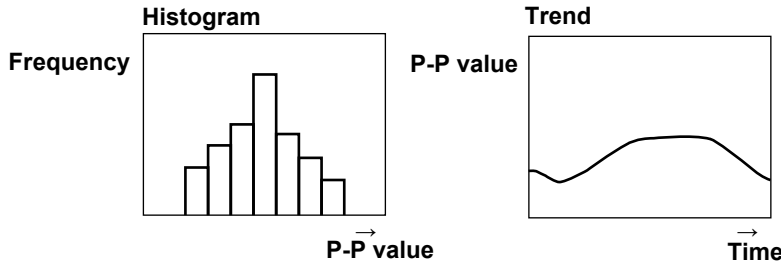

Displaying Trends and Histograms (Display)

Set whether or not to display trends or histograms. If you select ON, you can set the type of graph to display and the source. Trends and histograms are displayed in the Trend/Histogram window.

- **Display**
 - OFF: Does not displays trends or histograms
 - ON: Displays trends or histograms

- **Type of Graph to Display (Mode)**

You can set the type of graph you want to display to one of the settings below.

 - Trend: Trend of the calculated statistics
 - Histogram: Histogram of the calculated statistics

- **Display Source (Item)**

You can select the source waveform and the automatically measured item (you can only select one item) that will be shown in the trend or histogram display.

The measurement items that are turned on in the Item Setup screen for the automated measurement of waveform parameters appear in the list.

- **Configuring the Display (Display Setup)**

You can turn on and off the VT waveform display (shared with the trend and histogram display) and specify how to set the display scale (trend display only).

 - Auto Scale Exec

Executes auto scaling of the trend display Upper, Lower, and H-Span are set as follows:
 Upper/Lower: Set so that the difference between the maximum and minimum values of the waveform parameter is 80% of the waveform area.
 H-Span: Set so that all of the waveform parameter values that were measured before Auto Scale was executed are displayed.
 - Upper/Lower

Set the vertical scale values of the trend display.
 - H-Span

Set the horizontal scale values of the trend display. You can set this when the mode is set to Continuous or History.
 - H-Range

Select the window for setting the horizontal scale of the trend display. You can set this when the mode is set to Cycle.
 - VT Display

Set whether to display the VT waveform along with the trend or histogram display.
 OFF: Does not display the VT waveform display window
 ON: Displays the VT waveform display window



If the statistical processing mode is set to Continuous and you execute Auto Scale, H-Span is set to 100 if the number of waveform parameters that had been measured is less than or equal to 100.

- **Measurement (Measure Setup)**

On histograms, you can measure parameters such as peak values and maximum values and measure values using cursors.

- Mode (Mode)

OFF: Disables measurement.

Param: Measures the value of the selected parameter.

- Cursor Measurement (Cursor1 and Cursor2)

Measurement items C1, C2, and ΔC are used to measure the Cursor1 value, the Cursor2 value, and the difference between the two cursor values.

- Measurement Item (Item)

The instrument measures the values of the items listed below that you select.

Peak	Peak value
Max	Maximum value
Min	Minimum value
Mean	Mean value
σ	Standard deviation of the histogram
Median	Median*
Integ $\pm\sigma$	Percentage of values that fall within $\pm\sigma$ (%)
Integ $\pm 2\sigma$	Percentage of values that fall within $\pm 2\sigma$ (%)
Integ $\pm 3\sigma$	Percentage of values that fall within $\pm 3\sigma$ (%)
C1	Cursor1 value
C2	Cursor2 value
ΔC	Difference between Cursor1 and Cursor2

* Re-sorts the sampled points from the minimum to the maximum value and determines the value of the middle number.

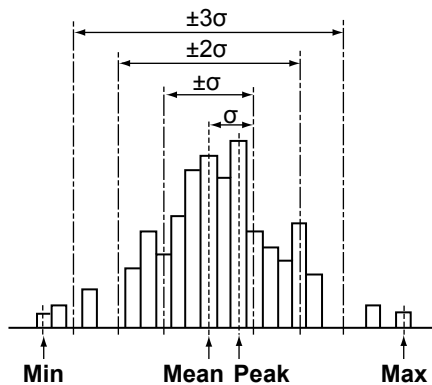

Enhanced Parameter Measurement (Enhanced)

The enhanced parameter measurement feature allows you to perform automated measurement of the waveform parameters of two areas. It also allows you to perform calculations using the automated measurement values of waveform parameters.

You cannot use the enhanced parameter measurement feature when the statistical processing mode is set to Cycle.

Configuring Area2 (Item Setup for Area2)

You can configure measurement items and other settings of the second area (Area2). The method to set the range is the same as that for the automated measurement of waveform parameters.

▶ [See here.](#)

Source Window (Time Range (Area2))

Selects the source window for Area2. The method to set the range is the same as that for the automated measurement of waveform parameters.

▶ [See here.](#)

Measurement Time Period (T Range1/T Range2)

Set the measurement range of Area2. The method to set the range is the same as that for the automated measurement of waveform parameters.

▶ [See here.](#)

Calculation Using Waveform Parameters (Calc Setup)

You can define four calculations (Calc1 through Calc4) that use the automated measurement values of waveform parameters.

Name (Name)

You can specify a name of up to eight characters in length for the computation that you have defined. The specified name is displayed on the screen.

Expression (Expression)

Be sure to include a waveform parameter in the expressions. The available operators and how to use them are described below.

Menu Item	Example	Description
+, -, *, /	Max(C1)-Min(C1)	Basic arithmetic of the input value
ABS	ABS(High(C1))	Absolute value of the input value
SQRT	SQRT(Volt1(C1))	Square root of the input value
LOG	LOG(Max(C2))	Logarithm of the input value
LN	LN(Min(C2))	Natural logarithm of the input value
EXP	EXP(Volt2(C1))	Exponent of the input value
P2	P2(Min(C1))	Square of the input value
SIN	SIN(Low(C1))	Sine of the input value
ASIN	ASIN(High(C2))	Arc sine of the input value
COS	COS(Max(C1))	Cosine of the input value
ACOS	ACOS(Min(C1))	Arc cosine of the input value
TAN	TAN(Volt1(C2))	Tangent of the input value
ATAN	ATAN(Volt2(C1))	Arc tangent of the input value
0 to 9	-	-
Exp		Exponent. Used to enter a number in scientific notation in expressions. (1E+3 = 1000, 2.5E-3 = 0.0025) Displayed as "E" in expressions to distinguish this from the "EXP" operator.
PI		Pi (π)
e		Euler's number, base of the natural logarithm (e = 2.71828...) Displayed as "eul" in expressions to distinguish this from the "E" that represents exponents.

fs		Sample rate. The instrument's sample rate when the computation was executed. The value changes according to the changes in the T/div or record length setting.
Measure Item	Max(C1)	Selects a waveform parameter.
A2	PP(C1,A2)	Specifies the calculation source area. If you want to calculate on Area2, add ",A2" after the calculation source channel.

Unit (Unit)

You can set the unit, which is used when the computed results are displayed, using up to four characters.

Notes about Automated Measurement of Waveform Parameters

- When an item is impossible to measure its measured value is displayed as '*****'.
- The instrument may not measure correctly if the waveform amplitude is small.
- To stop automated measurement, select OFF by pressing MEASURE > Mode soft key. Measurement stops immediately.
- **Notes about Statistical Processing**
If the statistical processing mode is set to Cycle or History, all keys and soft keys except the Abort soft key are invalid during statistical processing. In Continuous mode, the RUN/STOP key and TrigLevelChange Soft key are valid.

13 Zooming in on Waveforms

You can magnify the displayed waveforms vertically or horizontally.

The zoomed waveforms of two locations can be displayed simultaneously (the dual zoom feature). You can also specify which channel you want to zoom in on. You cannot zoom if the number of displayed points on the screen is less than or equal to 10.

Example of the Dual Zoom Display

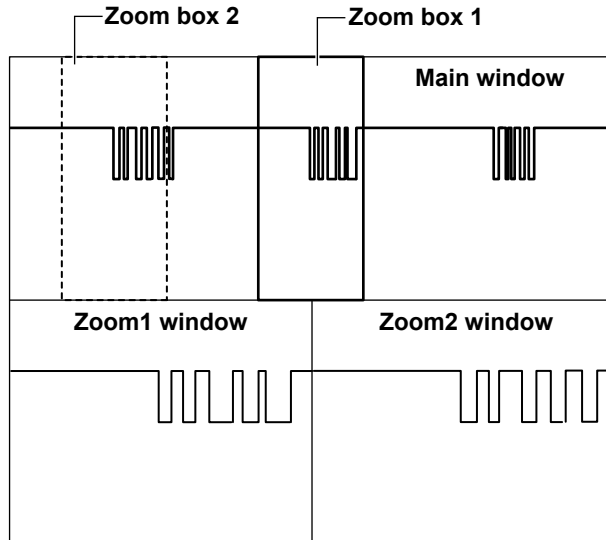

If the main window (which displays normal waveforms) and the Zoom1 or Zoom2 window are displayed at the same time, a zoom box appears in the Main window so that you can check the zoom position.

Turning the Zoom Windows On or Off (Display)

Sets whether or not to display zoom windows.

- OFF: Does not display the zoom windows
- ON: Displays the zoom windows



The ZOOM1 and ZOOM2 keys illuminate when the zoom feature is on. The ZOOM knob controls the waveforms in the window whose corresponding key is illuminated more brightly.

Display Format (Format)

Selects how to divide the zoom windows. Select from one of the settings below.

- Main: Same format as the Main window
 - Single: No divisions
 - Dual: Two divisions
 - Triad: Three divisions
 - Quad: Four divisions
 - Hexa: Six divisions*
 - Octal: Eight divisions*
- * Selectable only on the 4-channel model.





Displaying the Main Window (Main)

Selects which area to display the main window in.

- OFF: Does not display the main window
- On (20%): Displays the main window in the top 20% area of the screen
- On (50%): Displays the main window in the top half (50%) of the screen

Auto Scrolling (Auto Scroll)

Automatically moves the zoom position in the specified direction. You can view the zoom waveform and stop scrolling at the appropriate position.

	Zooms in on the left edge of the Main window
	Starts scrolling to the left
	Stop auto scrolling
	Starts scrolling to the right
	Zooms in on the right edge of the Main window

Scroll Speed (Speed)

Six different auto scroll speeds are available.

- Down: Decreases the scroll speed by one level.
- Up: Increases the scroll speed by one level.

Zoom Source Waveforms (Trace)

You can select the zoom source waveforms from the waveforms below.

The available settings vary depending on the model.

CH1 to CH4/LOGIC*, Math1 to Math4

* CH4 or LOGIC, whichever the corresponding key is illuminated, can be selected.



If you select a waveform whose display is turned off in the main window, the zoom waveform does not appear.

Zoom Factor (ZOOM knob)

You can set separate horizontal zoom factors for ZOOM1 and ZOOM2. The zoom window time axis settings change automatically based on the specified zoom factor.

Use the ZOOM knob to set the zoom factor.

Selectable Range

From twice the TIME/DIV setting of the main window up to the ratio at which the number of data points in the zoom window is 2.5



-
- If you push the ZOOM knob, the FINE indicator illuminates, and you can set the zoom factor with higher resolution.
 - The horizontal zoom factor applies to all waveforms that are displayed in the zoom window.
-

Zoom Position (Z1 Position, Z2 Position)

Taking the horizontal center of the main window to be 0 divisions, set the center position of the zoom boxes in the range of -5 to +5 divisions. In the Main window, the zoom box with solid lines is Zoom1, and the zoom box with dashed lines is Zoom2.

Waveforms are magnified around Z1 Position and Z2 Position.

Zoom Link

If the Zoom1 and Zoom2 windows are both displayed, you can select whether or not to maintain the distance between the two zoom boxes when you set the zoom position.

<input type="radio"/> Z1 Position/ <input checked="" type="radio"/> Z2 Position	The jog shuttle sets the zoom box 1 position.
<input checked="" type="radio"/> Z1 Position/ <input type="radio"/> Z2 Position	The jog shuttle sets the zoom box 2 position.
<input type="radio"/> Z1 Position/ <input type="radio"/> Z2 Position	The jog shuttle sets the zoom box 1 and 2 positions while maintaining the same distance between the two zoom boxes.

Vertical Zoom (Vertical Zoom)

Zoom Source Waveform

Set the zoom source waveform to one of the waveforms below.

The available settings vary depending on the model.

CH1 to CH4, Math1 to Math4

Zoom Position (V-Position)

Taking the vertical center of the main window to be 0 divisions, set the vertical center position of the zoom boxes in the range of -4 to 4 divisions. In the Main window, the zoom box with solid lines is Zoom1, and the zoom box with dashed lines is Zoom2.

Zoom Factor (V-Mag)

You can set separate vertical zoom factors for ZOOM1 and ZOOM2. The zoom window vertical axis settings change automatically based on the specified zoom factors.

Use the jog shuttle to set the zoom factors.

Selectable range: Up to 10 times

Initializing the Vertical Zoom

You can reset the vertical zoom factor and zoom position settings by pressing RESET.

14 Searching Waveforms

You can search the displayed waveforms for locations that match the specified conditions. You can zoom-in on the detected locations. You can search the waveforms within the specified search range over up to 50000 points.

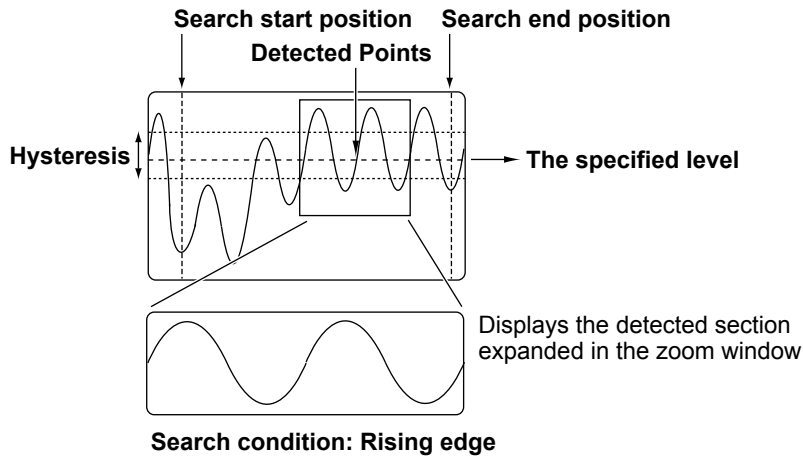

Search Source Waveform

You can search any of the following channel waveforms.

CH1 to CH4/LOGIC,* Math1 to Math4

* The selectable channels vary depending on the model. CH4 or LOGIC, whichever the corresponding key is illuminated, can be selected. If you select LOGIC, select the source bit (bit 0 to bit 7).



- If you select a channel that a reference waveform has been loaded into, you can search the reference waveform. ► [See here](#).
- If you set the source to a channel (CH1 to CH4) that a waveform has been loaded into, you can search the loaded waveform.

Search Type (Type)

Set the search method to one of the settings below. The search method of each search type is the same as the method of the corresponding trigger type.

Edge Search

Search for positions where the rising or falling slope of the specified waveform passes through the specified level.

Search Example

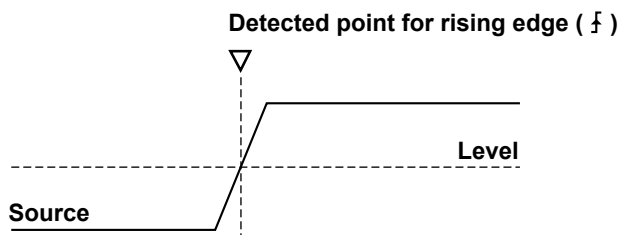

Pattern Search

Set the search source pattern and whether a clock source is available. The instrument searches for positions that meet the specified conditions.

When a Clock Source Is Specified

Search Example 1

The results of comparing the combination (Logic) of the trigger source signal pattern (Pattern) and the specified pattern are sampled on the edges of the clock source, and the instrument searches for the point of change in the comparison results (Enter or Exit of the search condition (Condition)).

Clock: CH3, \bar{F}
Pattern: CH1 = H, CH2 = L, other channels = X, Logic = AND
Condition: Enter

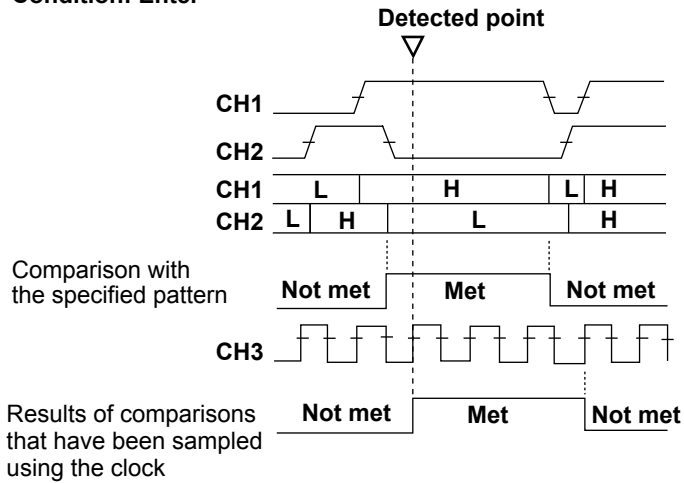

Search Example 2

When the result of comparing the combination (Logic) of the trigger source signal pattern (Pattern) and the specified pattern is true or false as specified by the achievement condition (Condition), the instrument searches for the edge of the clock source.

Clock: CH3, \bar{F}
Pattern: CH1 = H, CH2 = L, other channels = X, Logic = AND
Condition: Ture

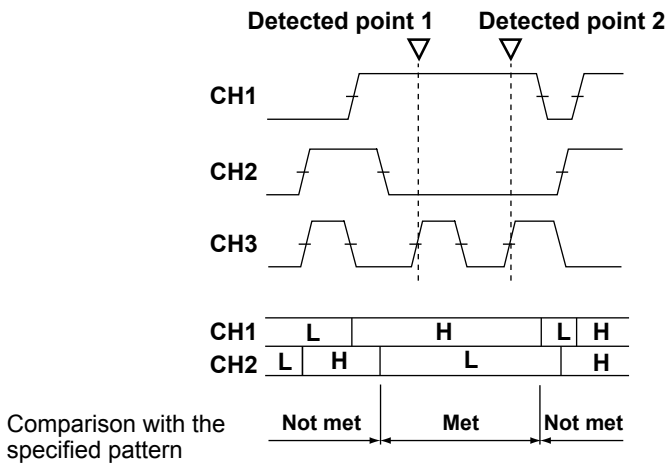

When a Clock Source Is Not Specified

Search Example 1

The instrument searches for the point of change in the results (Enter or Exit of the achievement condition (Condition)) of comparing the combination (Logic) of the trigger source signal pattern (Pattern) and the specified pattern.

Clock: None
Pattern: CH1 = H, CH2 = L, other channels = X, Logic = AND
Condition: Enter

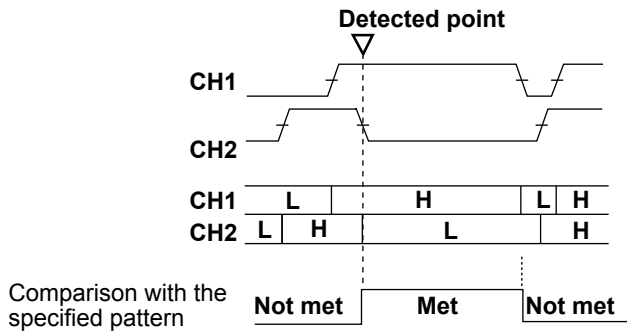

Search Example 2

The instrument searches for the end point of the achievement time (t) when the relationship between the duration the result (Enter or Exit of the achievement condition (Condition)) of comparing the combination (Logic) of the trigger source signal pattern (Pattern) and the reference time meets the specified time condition (Time Qualification). When the time condition is set to timeout, the instrument searches for the timeout point.

Clock: None
Pattern: CH1 = H, CH2 = L, other channels = X, Logic = AND
Condition: False
Time Qualification: More than (t>Time)

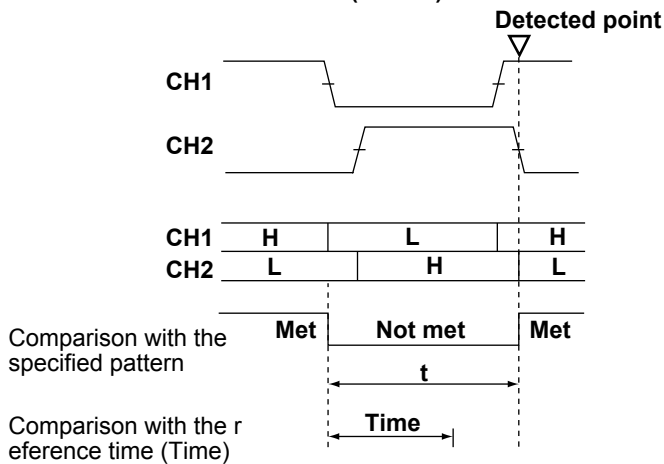

Pulse Width Search

The instrument searches for the position where the pulse width of the specified waveform meets the specified reference time.

Search Example

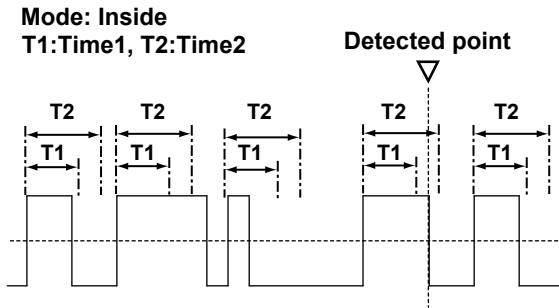

Timeout Search

The instrument searches for the timeout position from the point where the rising or falling slope of the specified waveform passes through the specified level.

Search Example

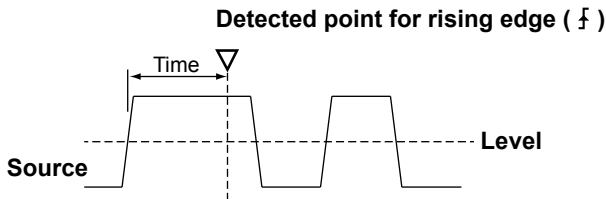

Search Conditions (Condition Setup)

Set the search source waveform, detection level, and other search conditions. The items that you need to set vary depending on the search type that you select.

Edge Search

Search Source Waveform (Source)

You can select from one of the settings below. The available settings vary depending on the model.

CH1 to CH4/LOGIC,* Math1 to Math4

* CH4 or LOGIC, whichever the corresponding key is illuminated, can be selected. If you select LOGIC, select the source bit (bit 0 to bit 7).

Slope (Slope)

You can select which slope edge to detect in the search source waveform.

⌈	Rising slope
⌋	Falling slope
⌈⌋	Rising or falling slope

Level (Level)

When the search source waveform is CH1 to CH4 or Math1 to Math4, set the level used to detect the search source waveform's rising or falling edge.

Selectable range: ±10 div

Resolution: 0.01 div

Hysteresis (Hysteresis)

When the search source waveform is CH1 to CH4 or Math1 to Math4, you can set a width (hysteresis) to the edge detection level so that the instrument does not detect edges on level changes within the specified width.

Selectable range: 0.3 div to 8.0 div

Resolution: 0.1 div

Pattern Search**Clock Source (Clock)**



You can select from one of the settings below. The available settings vary depending on the model.

CH1 to CH4/LOGIC*, Math1 to Math4, None (not specify a clock source)

* CH4 or LOGIC, whichever the corresponding key is illuminated, can be selected. If you select LOGIC, select the source bit (bit 0 to bit 7).

Clock Source Slope

Select the clock source slope.

	When the source changes from a level below the specified level to a level above the specified level (rising)
	When the source changes from a level above the specified level to a level below the specified level (falling)
	When a rising or falling edge is detected



You cannot set a pattern to a signal that is set as the clock source.

Search Conditions (Condition)

- **Search Source Pattern (Pattern)**

Set the search source (CH1 to CH4, Bit0 to Bit7, Math1 to Math4, excluding the clock source) pattern.

This item is the same as that of the trigger source pattern (Pattern) of the pattern trigger.

▶ [See here.](#)

- **Combination (Logic), Achievement Condition (Condition), Time Condition (Time Qualification)**

These items are the same as those of the pattern trigger.

▶ [See here.](#)

- **Reference Times (Time or Time1 and Time2)**

Selectable range: 1ns to 10s

- **Level (Level) and Hysteresis (Hys)**

Set the level and hysteresis used to detect the search source waveform state.

These items are the same as those of the edge search.

▶ [See here.](#)

Pulse Width Search

Search Source Waveform (Source)

You can select from one of the settings below. The available settings vary depending on the model.

CH1 to CH4/LOGIC,* Math1 to Math4

* CH4 or LOGIC, whichever the corresponding key is illuminated, can be selected. If you select LOGIC, select the source bit (bit 0 to bit 7).

Reference Time (Time)

Selectable range: 1 ns to 10 s

Polarity (Polarity), Time Condition (Mode)

This item is the same as that of the Pulse Width trigger.

▶ [See here.](#)

Level (Level) and Hysteresis (Hys)

Set the level and hysteresis used to detect the search source waveform state.

These items are the same as those of the edge search.

▶ [See here.](#)

Timeout Search

Search Source Waveform (Source)

You can select from one of the settings below. The available settings vary depending on the model.

CH1 to CH4/LOGIC,* Math1 to Math4



* CH4 or LOGIC, whichever the corresponding key is illuminated, can be selected. If you select LOGIC, select the source bit (bit 0 to bit 7).

Timeout Period (Time)

Selectable range: 1 ns to 10 s

Polarity (Polarity)

Select which polarity will cause the comparison with the timeout period. The search source polarity is based on the level.

	Pos (positive polarity)
	Neg (negative polarity)

Level (Level) and Hysteresis (Hys)

Set the level and hysteresis used to detect the search source waveform state.

These items are the same as those of the edge search.

▶ [See here.](#)

Displaying Detected Waveforms (Display Setup)

Displays the detected point of the detected point number specified by (Pattern No.) in the center of the zoom window.

When the pattern number is set to 2

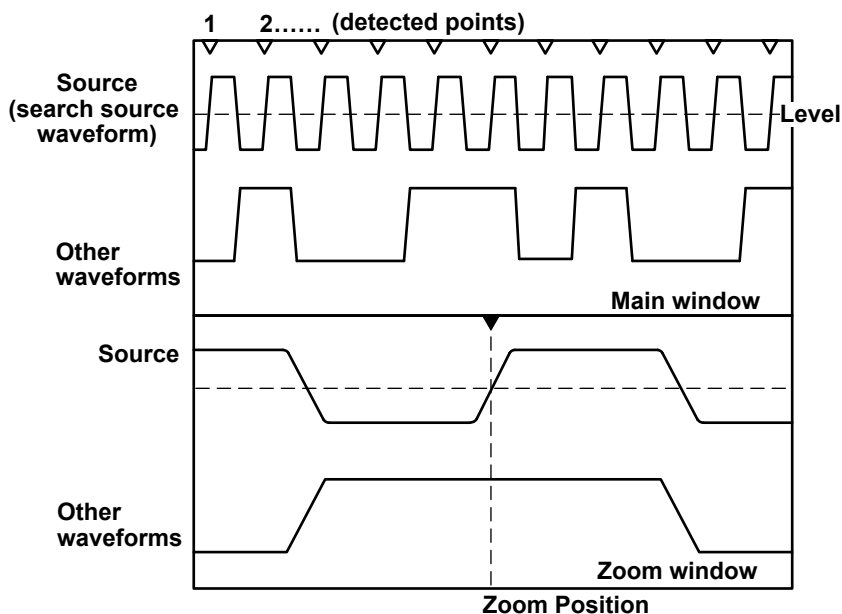

Mark (Mark)

Select whether or not to display marks on the detected points. When this feature is turned on, detected point marks appear at the top section of the main Window.

- OFF: Does not display the marks
- ON: Displays the marks

Specifying the Zoom Window (Result Window)

Select the Zoom1 or Zoom2 window to display an expanded view of the detected points.

You only need to make this selection when both the Zoom1 and Zoom2 displays are turned on.



If Zoom1 and Zoom2 displays are both off and you press SEARCH, the Zoom1 display turns on.

Zoom Position (Z1 Position, Z2 Position)

You can change the zoom position in the zoom window that is specified using Result Window in the menu accessible with the Display Setup soft key.

Search Skip (Skip Mode)

After a search condition is met, you can skip the detection of search conditions for the specified amount of time or the specified number of counts.

Set the skip method to one of the settings below.

- OFF: Searches for all points that meet the search conditions
- Holdoff: Skips the detection of search conditions for the specified amount of time (You can set the amount of time to a value from 0.1 ns to 1.00000 s (6 significant digits) in 0.1-ns steps.)
- Decimation: Skips the detection of search conditions for the specified number of counts (The selectable range is 1 to 9999.)

Search Range (Start/End Point)

Set the search start and stop points (Start Point/End Point) in the range shown below.
Selectable range: -5 div to +5 div

Detected Point number (Pattern No.)

Specify the number of the detected point to display in the zoom window.
Detected points are numbered in order. The first detected point is zero.
The maximum detected point number is 50000.

Executing a Search (Search)

The instrument searches for positions where the specified search conditions are met. Then, the instrument displays the waveform expanded in the zoom window with the detected point that corresponds to the number you specify at the center.

Detected Points

The detected points are the same as the trigger points.



-
- You cannot search while waveform acquisition is in progress (RUN).
 - You cannot search accumulated waveforms.
-

15 Analyzing and Searching Serial Bus Signals

The instrument can decode frames, fields, and other information from the waveform displayed on the screen. Then, it can display the decoded results along with the waveform on the screen or display a list of detailed decoded results.

If you set search conditions and perform searches, the waveform can be displayed expanded, with the detected frame's or field's first data byte at the center of the window.

The instrument can perform waveform analysis and searching on up to four serial bus signals (Serial Bus1(S1), Serial Bus2(S2), Serial Bus3(S3), and Serial Bus4(S4)). The instrument can search up to 50000 points on the selected serial bus signal.

* SERIAL BUS1(S1) only for 2-channel models

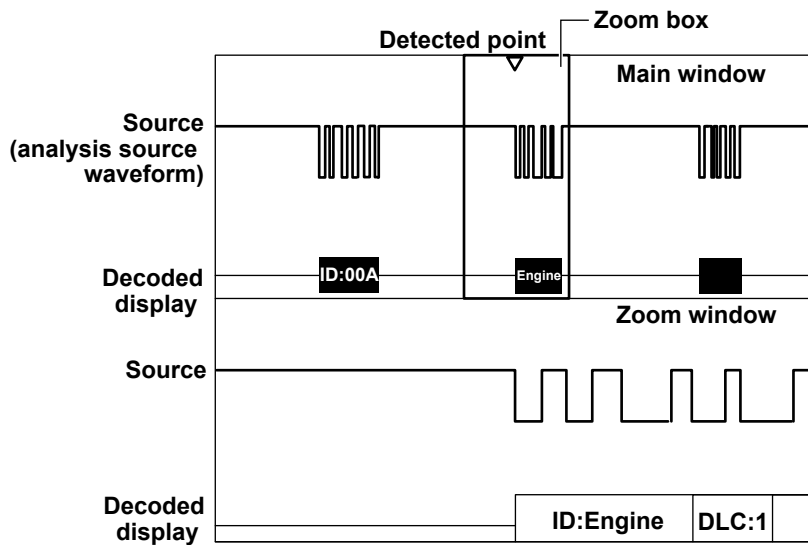

Turning the Analysis and Search Feature On or Off (Display)

Set whether or not to perform serial bus signal analysis and searching. If you turn this feature on, the instrument displays the decoded field values at the bottom of the screen.

- OFF: Does not perform serial bus signal analysis and searching
- ON: Performs serial bus signal analysis and searching

Number of Analyzable and Searchable Frames or Data Bytes

The maximum number of analyzable and searchable frames or data bytes varies depending on the serial bus type as follows:

FlexRay	5000 frames
CXPI	10000 frames
CAN FD	Up to 50000 frames
CAN/LIN/SENT	100000 frames
UART/I ² C/SPI/User Define	300000 bytes

Analysis and Search Source Waveform

You can analyze and search any of the following channel waveforms. The selectable channels vary depending on the model.

CH1 to CH4/LOGIC, Math1 to Math4

- CH4 or LOGIC, whichever the corresponding key is illuminated, can be selected.
- You can select LOGIC only for SENT, UART, I²C, and SPI serial bus signals. If you select LOGIC, select also the source bit (bit 0 to bit 7).



- If you select a channel that a reference waveform has been loaded into, you can analyze and search through the reference waveform. ► [See here](#).
 - If you set the source to a channel (CH1 to CH4) that a waveform has been loaded into, you can analyze and search through the loaded waveform.
 - Set the time scale and record length so that the sample rate displayed in the upper right of the screen is at least 10 times the signal bit rate. The instrument may not be able to analyze or search if the sample rate is low.
-

Serial Bus Signal Type (Type)

Select the serial bus signal type to analyze and search from one of the settings below. FlexRay, CAN, CAN FD, LIN, CXPI, SENT, UART, I²C, and SPI are options for 4-channel models.

- [FlexRay](#): FlexRay bus signal
- [CAN](#): CAN bus signal
- [CAN FD](#): CAN FD bus signal
- [LIN](#): LIN bus signal
- [CXPI](#): CXPI bus signal
- [SENT](#): SENT signal
- [UART](#): UART signal
- [I2C](#): I²C bus signal
- [SPI](#): SPI bus signal
- [User Define](#): User-defined serial bus signal

Bus Setup (Setup)

Configure the settings necessary for serial bus signal analysis. The settings vary depending on the bus type.

Auto Setup (Auto Setup)

If you specify the serial bus type and source, the instrument can automatically set the bit rate and source level. The auto setup feature will not work properly on some input signals.

You can cancel auto setup by pressing the Abort soft key.

Search Setup (Search)

Set the serial bus signal search conditions. The conditions that you set vary depending on the search source signal.

Specifying the Zoom Window (Result Window)

Select the Zoom1 or Zoom2 window to display an expanded view of the detected points.

You only need to make this selection when both the Zoom1 and Zoom2 displays are turned on.



If the Zoom1 and Zoom2 displays are both off and you press SERIAL BUS (SHIFT+SEARCH) and then set Display to ON, the Zoom1 display turns on.

Detected Point Number (Pattern No.)

Specify the number of the detected point (the location where the search condition was met) you want to display in the zoom window.

Detected points are numbered in order. The first detected point is zero.

The maximum detected point number is 50000.

Zoom Position (Z1 Position, Z2 Position)

You can change the zoom position in the zoom window that is specified using Result Window in the menu accessible with the Search soft key. You can also link the analysis number (List No.) and zoom position settings.

▶ [See here.](#)

Decoded Display (Decode)

The instrument decodes each field value and displays the decoded result using different colors for each field at the bottom of the screen.

The following table shows the available decode display formats.

Decode Format	Hex	Dec	Bin	ASCII	Symbol	
FlexRay	Yes	No	Yes	No	No	
CAN	Yes	No	Yes	No	Yes*	
CAN FD	Yes	No	Yes	No	Yes*	
LIN	Yes	No	Yes	No	No	
Serial bus	CXPI	Yes	No	Yes	No	No
	SENT	Yes	Yes	No	No	No
	UART	Yes	No	Yes	Yes	No
	I ² C	Yes	No	Yes	Yes	No
	SPI	Yes	No	Yes	Yes	No
User Define	Yes	No	Yes	Yes	No	

* You can display the decoded results using symbols by converting a CANdb file (.dbc) to a physical value/symbol definition file (.sbl) using the free YOKOGAWA conversion software “Symbol Editor” and by loading the file into the instrument.

Display Example

When Bin display is used, a bit order that is appropriate for the displayed waveforms is used regardless of the bit order setting.

The bit order setting varies depending on the bus type.

CRC of FlexRay, CAN, CAN FD, I ² C, SENT (except when the data type is User)	MSB
Data of LIN, CXPI	LSB
UART, SPI, SENT (when the data type is User)	LSB or MSB



0	1	0	1	0	0	1	1
C				A			
5				3			

Binary display
Hexadecimal display (bit order: LSB)
Hexadecimal display (bit order: MSB)

15 Analyzing and Searching Serial Bus Signals

When I²C bus signals are being analyzed, the display of the decoded address pattern is affected by whether the R/W bit is on or off.

7-bit Address Example

Address R/W bit

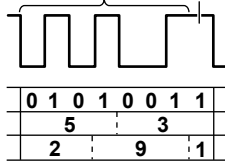

In the binary display, the address and R/W bit are both in binary (01010011).

In the hexadecimal display when Include R/W is on, the address and R/W bit are both in hexadecimal (0x53).

In the hexadecimal display when Include R/W is off, the address is in hexadecimal (0x29), and the R/W bit is in binary (1).

List Display (List)

You can display a list of decoded results. You can list the decoded results of four serial bus signals. You can also display the waveform of a specified analysis number in the zoom window.

Listing is not possible when the source is a user-defined serial bus signal.

Turning Zoom Linking On and Off (Zoom Link)

When Zoom Link is set to ON, the analysis number and zoom position settings are linked. When Zoom Link is set to OFF, the analysis number and zoom position settings are not linked. The default setting is ON.

List Size (List Size)

Select the list size and display position from one of the settings below.

- Full Screen: Displays the list in full-screen mode
- Half(Upper): Displays the list in the top half of the screen
- Half(Lower): Displays the list in the bottom half of the screen

Detailed Display (Detail)

If the bus type is UART(When Grouping is on), I²C, or SPI, the instrument displays all of the data for the specified analysis number in hexadecimal notation and ASCII codes. If you show the detailed display, you can view the data from the 17th byte.

Analysis Number (List No.)

The line on the list that corresponds to the number you select is highlighted. When Zoom Link is set to ON, the zoom window displays the waveform expanded with the start of the frame that corresponds to the selected analysis number at the center of the window.

Trend Display (Trend)

You can display the trend of decoded SENT signal data. For each analysis of serial bus signals (Serial Bus1 (S1), Serial Bus2 (S2), Serial Bus3 (S3), Serial Bus4 (S4)), up to four trends can be displayed.

Saving the Analysis Results

You can save the analysis results (the data list of the decoded results) in CSV format to a storage device. The extension is .csv.

For details on saving the serial bus analysis results, see “Serial Bus Analysis Results (Serial Bus)” in chapter 20, “Saving and Loading Data.” ► [See here.](#)

You cannot save the results of analyzing a user-defined serial bus signal (User Define).

Analyzing and Searching FlexRay Bus Signals (Option)

Analysis Source Frame

You can analyze the following frames and patterns.

Frame Start, Error, ID/Data

For the frame format, see “[FlexRay Bus Trigger](#)” in chapter 4, “Triggering.”

Bus Setup (Setup)

Source (Source)

Set the analysis source to one of the settings below.

CH1 to CH4*, Math1 to Math4

* You can select CH4 when the key is illuminated.

Bit Rate (Bit Rate)

Select the FlexRay bus signal’s data transfer rate from one of the settings below.

2.5 Mbps, 5 Mbps, 10 Mbps

Bus Channel (Channel)

Select A or B.

Level and Hysteresis (Level/Hysteresis)

These items are the same as those of the edge search.

▶ [See here.](#)

Auto Setup (Auto Setup)

Executes auto setup based on the specified sources.

The auto setup feature automatically configures the bit rate, bus channel, level, and hysteresis and triggers on the start of frame (Frame Start) of the FlexRay bus signal.

You cannot execute auto setup if the source is set to Math1 to Math4.

Decoded Display (Decode)

The colors that are used for the fields in the decoded display are as follows:

Indicator	Yellow (Yellow)
Frame ID	Light green (Light Green)
Payload	Pink (Pink)
Header CRC	Light blue (Light Blue)
Cycle Count	Orange (Orange)
Data	Cyan (Cyan)
CRC	Light blue (Light Blue)
BSS	Gray (Gray) fill
Error	Red (Red) BSS Error, FES Error: Displays the words “BSS Error” or “FES Error” in the field in which the error occurred using black characters on red background. Header CRC Error, CRC Error: Displays the characters of the field in which an error occurred using black characters on red background.

List Display (List)

The list displays the following items.

No.	Analysis number. Negative numbers are assigned to frames before the and positive numbers are assigned to frames after the trigger position.* The instrument can display the analysis results for up to 5000 frames in the range of -5000 to 5000. Pressing the RESET key highlights frame number zero.
Time(ms)	Displays the time from the trigger position* to the start of the frame in milliseconds.
S/D	Displays the frame type. S: Static Frame, D: Dynamic Frame
IND	Displays the states of the four header segment indicators in the following order using bit patterns. Payload preamble indicator, Null frame indicator, Sync frame indicator, Startup frame indicator
ID	Displays the 11-bit frame ID in decimal notation.
Len	Displays the data length of the payload segment in decimal notation.
CC	Displays the cycle-count value in decimal notation.
Data	Displays Data 0 to Data n of the payload segment (n = byte 0 to 253) in hexadecimal notation.
Information	Displays the following error information. If multiple errors are detected in one frame, the instrument displays the error with the highest precedence. The errors are listed below in order of precedence with the highest precedence error first. BSS Error: BSS not detected, FES Error: FES not detected, Header CRCError: Incorrect header CRC, CRC Error: incorrect CRC

* If [delay cancel \(Delay Cancel\)](#) is set to OFF, they are based on the trigger point.

Search Setup (Search)

Search Type (Mode)

Select the FlexRay bus signal search type from one of the settings below.

- Frame Start: Searches for the starting position of the frame
 - Error: Searches for errors
 - ID/Data: Searches for the position where the AND condition of the ID bit pattern and Data pattern is met
- If you set the type to Error or ID/Data, set the search conditions.

The method to set search conditions is the same as that for the trigger conditions of the FlexRay bus trigger.

▶ [See here.](#)

Executing a Search (Search)

The instrument searches for locations where the specified search conditions are met. Then, the instrument displays the frame corresponding to the specified detected point number (Pattern No) expanded in the zoom window.

Detected Points

The detected points are the same as the trigger points.

▶ [See here.](#)

Jumping to the Specified Field (Field Jump)

You can move the zoom position to the start of the following fields in the frame corresponding to the specified detected point number.

ID, Payload Length, Header CRC, Cycle Count, CRC

Analyzing and Searching CAN Bus Signals (Option)

Analysis Source Frame

The following frames can be analyzed.

Remote, data, error, and overload frames

For the CAN frame format, see “[CAN Bus Trigger](#)” in chapter 4, “Triggering.”

Bus Setup (Setup)

Source (Source)

Set the analysis source to one of the settings below.

CH1 to CH4,* Math1 to Math4

* You can select CH4 when the key is illuminated.

Bit Rate (Bit Rate)

Select the CAN bus signal's data transfer rate from one of the settings below.

33.3 kbps, 83.3 kbps, 125 kbps, 250 kbps, 500 kbps, 1 Mbps, User Define

If you select User Define, set the transfer rate in the range of 10 kbps to 1 Mbps in 0.1-kbps steps.

Recessive Level (Recessive)

Select the recessive level from one of the settings below. In either setting, the logical value of the recessive level is 1, and the logical value of the dominant level is 0.

H	The recessive level is greater than the dominant level.
L	The recessive level is less than the dominant level.

Sample Point (Sample Point)

Set the reference that will be used to determine the bus level (recessive or dominant) in the range of 18.8 to 90.6% in 3.1% steps.

Level (Level) and Hysteresis (Hys)

These items are the same as those of the edge search.

▶ [See here.](#)

Auto Setup (Auto Setup)

Executes auto setup based on the specified sources.

The auto setup feature automatically configures the bit rate, recessive level, sample point, level, and hysteresis and triggers on the start of frame (SOF) of the CAN bus signal.

You cannot execute auto setup if the source is set to Math1 to Math4.

Decoded Display (Decode)

The colors that are used for the fields in the decoded display are as follows:

Arbitration	Light green (Light Green)
Control	Pink (Pink)
Data	Cyan (Cyan)
CRC	Light blue (Light Blue)
Error bit, field in which the error occurred, frame, error frame	Red (Red)
Overload frame	Green (Green)
Frame background	Gray (Gray)
Stuff bits	Gray (Gray) fill

List Display (List)

The list displays the following items.

No.	Analysis number. Negative numbers are assigned to frames before the and positive numbers are assigned to frames after the trigger position.* The instrument can display the analysis results for up to 100000 frames in the range of -99999 to 99999. Pressing the RESET key highlights frame number zero.
Time(ms)	Displays the time from the trigger position* to the start of the frame in milliseconds.
Frame	Displays the frame type. The instrument can analyze the following four frame types: data frame (Data), remote frame (Remote), error frame (Error), and overload frame (Over load).
ID	Displays the 11-bit standard format ID value or the 29-bit extended format ID value in hexadecimal notation. If decode (Decode) is set to Symbol, the ID is displayed with the message name.
DLC	Displays the number of significant digits in hexadecimal notation.
Data	Displays the data in hexadecimal notation when the frame type is data frame. If decode (Decode) is set to Symbol, Data is displayed with physical values.
CRC	Displays the sequence in hexadecimal notation. This is displayed when the frame type is data frame or remote frame.
Ack	Displays "Y" when an ACK bit is detected and "N" otherwise.
Information	Displays the following error information. If multiple errors are detected in one piece of data, the instrument displays a single error in the following order of precedence. Stuff Error, CRC Error

* If [delay cancel \(Delay Cancel\)](#) is set to OFF, they are based on the trigger point.

Search Setup (Search)

Search Type (Mode)

Select the CAN bus signal search type from one of the settings below.

- SOF: Searches for the start-of-frame position
 - Error: Searches for errors
 - ID/Data: Searches for the position where the AND condition of the ID bit pattern and Data pattern is met
- If you set the type to Error or ID/Data, set the search conditions.

The method to set search conditions is the same as that for the trigger conditions of the CAN bus trigger.

▶ [See here.](#)

Executing a Search (Search)

The instrument searches for locations where the specified search conditions are met. Then, the instrument displays the frame corresponding to the specified detected point number (Pattern No) expanded in the zoom window.

Detected Points

The detected points are the same as the trigger points.

▶ [See here.](#)

Jumping to the Specified Field (Field Jump)

You can move the zoom position to the start of the following fields in the frame corresponding to the specified detected point number.

SOF, ID, Control Field, Data Field, CRC, ACK

Analyzing and Searching CAN FD Bus Signals (Option)

Analysis Source Frame

The following frames can be analyzed.

Remote, data, error, and overload frames

For the CAN FD frame format, see “[CAN FD Bus Trigger](#)” in chapter 4, “Triggering.”

Bus Setup (Setup)

Source (Source)

This item is the same as that of the CAN bus.

▶ [See here.](#)

Bit Rate (Bit Rate)

Select the CAN FD bus signal's arbitration phase data transfer rate from one of the settings below.

250 kbps, 500 kbps, 1 Mbps, User Define

If you select User Define, set the transfer rate in the range of 20 kbps to 1 Mbps in 0.1-kbps steps.

Sample Point (Sample Point)

Set the reference that will be used to determine the bus level (recessive or dominant) of the CAN FD bus signal's arbitration phase in the range of 18.8 to 90.6% in 0.1% steps.

Data Bit Rate (Data BitRate)

Select the CAN FD bus signal's data phase data transfer rate from one of the settings below.

500 kbps, 1 Mbps, 2 Mbps, 4 Mbps, 5 Mbps, 8 Mbps, User Define

If you select User Define, set the transfer rate in the range of 250 kbps to 10 Mbps in 0.1-kbps steps.

The data bit rate can be set as high as 16 times the arbitration phase bit rate.

Sample Point of the Data Phase (Sample Point)

Set the reference that will be used to determine the bus level (recessive or dominant) of the CAN FD bus signal's data phase in the range of 18.8 to 90.6% in 0.1% steps.



If the data bit rate exceeds 16 times the bit rate, the rates are automatically adjusted according to the last set value so that the relationship “data bit rate \leq bit \times 16” is maintained.

Recessive Level (Recessive)

This item is the same as that of the CAN bus.

▶ [See here.](#)

CAN FD Standard (FD Standard)

Select the compliant standard for the CAN FD bus signal to be applied.

ISO: ISO 11898-1: Analyzed as a 2015-compliant CAN FD bus signal.

non-ISO:ISO 11898-1: Analyzed as a CAN FD bus signal compliant to a standard before 2015.

Level (Level) and Hysteresis (Hys)

These items are the same as those of the edge search.

▶ [See here.](#)

Auto Setup (Auto Setup)

Set the CAN FD standard for the specified source and then execute auto setup.

The auto setup feature automatically configures the bit rate, recessive level, sample point, level, and hysteresis, and triggers on the start of frame (SOF) of the CAN FD bus signal.

You cannot execute auto setup if the source is set to Math1 to Math4.

Decoded Display (Decode)

The colors that are used for the fields in the decoded display are as follows:

Arbitration	Light green (Light Green)
Control ¹	Pink (Pink)
Data	Cyan (Cyan)
Stuff Count ²	Light blue (Light Blue)
CRC	Light blue (Light Blue)
Error bit, field in which the error occurred, ³ frame, error frame	Red (Red)
Overload frame	Green (Green)
Frame background	Gray (Gray)
Stuff bits	Gray (Gray) fill
ESI bit and frame when the ESI bit is recessive ³	Orange (Orange)
FDF bit and frame when the FDF bit is recessive ³	Dark blue (Dark Blue)
Frame when the FDF bit is dominant ³	Light blue (Light Blue)

- 1 If the FDF bit is recessive and display space is available, FD is displayed in front of DLC.
- 2 This appears when the CAN FD standard (FD Standard) is set to ISO.
- 3 The order of precedence when these frames overlap is the frame in which the error occurred, frame when the ESI bit is recessive, the frame when the FDF bit is dominant, and the frame when the FDF bit is recessive.

List Display (List - Show List)

The list displays the following items.

No.	Analysis number. Negative numbers are assigned to frames before the and positive numbers are assigned to frames after the trigger position.* The instrument can display the analysis results for up to 50000 frames in the range of -49999 to 49999. Pressing the RESET key highlights frame number zero.
Time(ms)	Displays the time from the trigger position* to the start of the frame in milliseconds.
Frame	Displays the frame type. The instrument can analyze the following four frame types: data frame (Data), remote frame (Remote), error frame (Error), and overload frame (Over load). If the FDF bit is recessive, FD is displayed in front of Data.
ID	Displays the 11-bit standard format ID value or the 29-bit extended format ID value in hexadecimal notation. If decode (Decode) is set to Symbol, the ID is displayed with the message name.
DLC	Displays the number of significant digits in hexadecimal notation.
Data	Displays the data in hexadecimal notation when the frame type is data frame. If decode (Decode) is set to Symbol, Data is displayed with physical values. If the number of bytes is 9 or higher, every 8 bytes of data is displayed in its own line.
SC	Displays the 4-bit value of the stuff bit count and parity in hexadecimal notation. This appears when the CAN FD standard (FD Standard) is set to ISO.
CRC	Displays the sequence in hexadecimal notation. This is displayed when the frame type is data frame or remote frame.
Ack	Displays "Y" when an ACK bit is detected and "N" otherwise.
Information	Displays the following error information. If multiple errors are detected in one piece of data, the instrument displays a single error in the following order of precedence. Stuff Error, Fixed Stuff Error, CRC Error If the CAN FD standard (FD Standard) is set to ISO, the CRC error is displayed as follows according to the error type. CRC Error (SC): Stuff Count error, CRC Error (Seq): CRC Sequence error, CRC Error (SC,Seq): Both Stuff Count and CRC Sequence error In addition to error information, if the ESI bit is recessive (error passive), "ESI(Error Passive)" is displayed.

* If **delay cancel (Delay Cancel)** is set to OFF, they are based on the trigger point.

Search Setup (Search)

Search Type (Mode)

Select the CAN FD bus signal search type from one of the settings below.

- SOF: Searches for the start-of-frame position
- Error: Searches for errors
- ID/Data: Searches for the position where the AND condition of the ID bit pattern and Data pattern is met
- FDF: Searches for an FDF bit state
- ESI (Error Passive): Searches for when the ESI bit is recessive (error passive)

SOF(Start of Frame)

The instrument searches for the start position of CAN FD bus signal frames.

Error

The instrument searches for error frames (when the error flag is active) or various errors.

- **Error Type (Error Type OR)**

Error Frame	When an active error flag (indicated by six consecutive dominant bits) is detected
Stuff	When stuff bits are not inserted properly
Fixed Stuff	When fixed CRC stuff bits are not inserted properly
CRC	When a CRC error is detected If the aforementioned CAN FD standard is set to ISO, select the CRC error factor from one of the settings below. You can also select both. Stuff Count, CRC Sequence

ID/Data

The instrument searches for data frames and remote frames in the standard format (Standard) and the extended format (Extend).

The instrument searches on the AND of the SOF, ID, frame type (Remote Frame or Data Frame), Data, and ACK conditions.



- If you specify X in the ID bit pattern or data pattern, the condition is assumed to be met regardless of the corresponding bit status.
- In a bit pattern or data pattern setting, if a binary pattern contains any Xs, the corresponding hexadecimal display will be "\$."

- **Search Conditions (Condition Setup)**

On the Condition Setup screen, set the search conditions such as the frame type (Remote Frame or Data Frame) and data.

Frame Format

Select the frame format.

- Standard: Standard format
- Extend: Extended format

SOF

Searches for the start of a CAN FD bus signal frame when the trigger condition is set to SOF only. SOF of ID/Data is always selected as a search condition.

ID

Input Format (Input format)

Select the ID input format from one of the settings below.

- Pattern: Set the ID bit pattern in hexadecimal or binary notation.
- Message: Select this setting to set the ID or Data search conditions by using messages and signals that are defined in the symbol definition file (sbl).

Bit Pattern (Hex/Bin)

Set the 11-bit standard format ID bit pattern or the 29-bit extended format ID bit pattern in hexadecimal (Hex) or binary (Bin) notation. The ID search condition is met when the input signal ID bit pattern matches the specified bit pattern.

Remote Frame/Data Frame

Set the search source frame to Remote Frame or Data Frame.

Data

You can set a search condition based on the data field value. Specify the size, position, condition, and data pattern settings. You can only set these items when you set the trigger source frame to Data Frame.

Comparison Size (Size)

Set the data length to be compared. The data pattern with the specified data length is compared to the input signal data pattern. If "0" is specified, the instrument assumes that a point has been detected regardless of the input signal's data field value.

Selectable range: 0 to 8 bytes

Comparison Start Position (Position)

Set the position to start comparing the data pattern. The left end of the data field is position 0.

Selectable range: 0 to 63 bytes



-
- If the comparison size (Size) is set to 0, comparison start position (Position) cannot be set.
 - The selectable range for position is limited so that Size + Position is less than or equal to 64.
-

Comparison Condition (Condition)

The data search condition is met when the result of comparing the data pattern or reference value to the input signal's data field meets the specified comparison condition.

True	When the value matches the data pattern
False	When the value does not match the data pattern
Data=a ¹	When the value is equal to the reference value
Data≠a ¹	When the value is not equal to the reference value
a≤Data ¹	When the value is greater than or equal to the reference value
Data≤b ¹	When the value is less than or equal to the reference value
a≤Data≤b ²	When the value is within the reference range (including the reference values)
Data<a, b<Data ²	When the value is outside the reference range (excluding the reference values)

- 1 Set one reference value
- 2 Set two reference values

Data Pattern (Hex/Bin)

If the comparison condition is set to True or False, set the data pattern for the specified size in hexadecimal (Hex) or binary (Bin) notation.

Reference Values (a and b)

If the comparison condition is set to Data = A, Data ≠ a, $a \leq \text{Data}$, $\text{Data} \leq b$, $a \leq \text{Data} \leq b$, or “Data < a or b < Data,” set the reference values in decimal notation. You must set the byte order (Endian), sign (Sign), and comparison range (MSB or LSB).

The selectable ranges are as follows:

Unsigned (Unsign)	0 to 9E+18 The selectable maximum value is limited by the data length and bit position, which are determined by the Size and MSB/LSB settings, respectively.
Signed (Sign)	-9E+18 to 9E+18 The selectable minimum and maximum values are limited by the data length and bit position, which are determined by the Size and MSB/LSB settings, respectively.

The value is displayed in scientific notation when the number of digits exceed seven (example: 1234567E+10).



If the comparison condition is $a \leq \text{Data} \leq b$ or “Data < a or b < Data,” the two reference values are automatically adjusted so that the lower limit is less than or equal to the upper limit.

Byte Order (Endian), Sign (Sign), and Comparison Range (MSB/LSB)

These items are the same as those of the CAN bus trigger.

▶ [See here.](#)

ACK Mode

These items are the same as those of the CAN bus trigger. Set the ACK slot state as a search condition.

▶ [See here.](#)

Message/Signal

These items are the same as those of the CAN bus trigger. Set the search conditions using Message and Signal. Messages can be used when the ID input format is set to Message.

▶ [See here.](#)

FDF

Set the FDF bit state as a search condition.

0 (CAN): When the FDF bit is dominant, the instrument assumes that the frame is a CAN bus signal frame and detects it.

1 (CAN FD): When the FDF bit is recessive, the instrument assumes that the frame is a CAN FD bus signal frame and detects it.

ESI(Error Passive)

When the ESI bit is recessive (error passive), the instrument detects it as a detected point.

Executing a Search (Search)

The instrument searches for locations where the specified search conditions are met. Then, the instrument displays the frame corresponding to the specified detected point number (Pattern No) expanded in the zoom window.

Detected Points

The detected points are the same as the trigger points.

▶ [See here.](#)

Jumping to the Specified Field (Field Jump)

You can move the zoom position to the start of the following fields in the frame corresponding to the specified detected point number.

SOF, ID, Control Field, Data Field, CRC, ACK

Analyzing and Searching LIN Bus Signals (Option)

Analysis Source Field

You can analyze the following fields and patterns.

Break, Synch, ID, Data, Checksum

For the LIN frame format, see “[LIN Bus Trigger](#)” in chapter 4, “Triggering.”

Bus Setup (Setup)

Source (Source)

Set the analysis source to one of the settings below.

CH1 to CH4,* Math1 to Math4

* You can select CH4 when the key is illuminated.

Bit Rate (Bit Rate)

Select the LIN bus signal's data transfer rate from one of the settings below.

1200 bps, 2400 bps, 4800 bps, 9600 bps, 19200 bps, User Define

If you select User Define, set the transfer rate in the range of 1000 bps to 20000 bps in 10-bps steps.

Revision (Revision)

Set the revision to one of the settings below.

- LIN 1.3: Only uses classic checksums, which only include the data field.
- LIN 2.0: Only uses enhanced checksums that include the protection ID. However, classic checksums are used for ID = 60 (0x3c) to 63 (0x3f).
- Both: Uses both the enhanced check sum and the classic checksum.

Sample Point (Sample Point)

You can set the reference that will be used to determine the bus level in the range of 18.8 to 90.6% in 3.1% steps.

Level (Level) and Hysteresis (Hys)

These items are the same as those of the edge search.

▶ [See here.](#)

Auto Setup (Auto Setup)

Executes auto setup based on the specified sources.

The auto setup feature automatically configures the bit rate, revision, sample point, level, and hysteresis and triggers on the LIN bus signal's Break Synch.

You cannot execute auto setup if the source is set to Math1 to Math4.

Decoded Display (Decode)

The colors that are used for the fields in the decoded display are as follows:

Break	Orange (Orange)
Synch	Pink (Pink)
ID	Light green (Light Green)
Data	Cyan (Cyan)
Checksum	Light blue (Light Blue)
WakeUp	Green (Green)
Start Bit	Gray (Gray) fill
Stop Bit	Gray (Gray) fill
Error	Red (Red)
	Timeout Error: Displays a thick red line in the area where an error has occurred.
	Framing Error: Displays the words “Framing Error” in the field in which an error occurred using black characters on red background. The instrument displays this error with higher precedence than checksum, synch, and parity errors.
	Checksum Error, Synch Error, Parity Error: Displays the characters of the synch, ID, or checksum field in which an error occurred using black characters on red background.

List Display (List)

The list displays the following items.

No.	Analysis number. Negative numbers are assigned to frames before the and positive numbers are assigned to frames after the trigger position.* The instrument can display the analysis results for up to 100000 frames in the range of -99999 to 99999. Pressing the RESET key highlights frame number zero.
Time(ms)	Displays the time from the trigger position* to the start of the frame in milliseconds.
ID	Displays the ID value in hexadecimal notation.
ID-Field	Displays the ID value including the 2-bit parity in hexadecimal notation.
Data	Displays the data in hexadecimal notation.
Checksum	Displays the checksum value in hexadecimal notation.
Information	Detects and displays the following signals and errors. If a WakeUp signal is detected, the instrument displays "WakeUp." If multiple errors are detected in one frame, the instrument displays the error with the highest precedence. The errors are listed below in order of precedence with the highest precedence error first. Timeout-Error, Framing-Error, Checksum-Error, Synch-Field-Error, ID-Parity-Error

* If [delay cancel \(Delay Cancel\)](#) is set to OFF, they are based on the trigger point.

Search Setup (Search)

Search Type (Mode)

Select the LIN bus signal search type from one of the settings below.

- Break Synch: Searches for break and synch fields
- Error: Searches for errors
- ID/Data: Searches for both the ID bit pattern and Data pattern (AND)

The method of setting Break Synch and ID/Data is the same as that of setting the LIN bus trigger conditions.

However, you cannot specify the break length as a search condition.

▶ [See here.](#)

Error Type (Error Type Or)

If you set the search mode to Error, select the error types to search for from the following settings.

Parity	The instrument calculates the parity of the protected identifier field. If the result does not satisfy the following equations, the instrument triggers on the protected identifier field's stop bit position. Even Parity Check: $ID0 \text{ xor } ID1 \text{ xor } ID2 \text{ xor } ID4 \text{ xor } P0 = 0$ $P0 = ID0 \text{ xor } ID1 \text{ xor } ID2 \text{ xor } ID4$ ODD Parity Check: $ID1 \text{ xor } ID3 \text{ xor } ID4 \text{ xor } ID5 \text{ xor } P1 = 1$ $P1 = \neg(ID1 \text{ xor } ID3 \text{ xor } ID4 \text{ xor } ID5)$
Checksum	Revision LIN 1.3 (classic checksum): If the calculated result of all data fields and the checksum is not 0xFF, the instrument triggers on the checksum field's stop bit position. Revision LIN 2.0 (enhanced checksum): If the total value ¹ of the protected identifier field, all data fields, and the checksum is not 0xFF, the instrument triggers on the checksum field's stop bit position. However, if the protected identifier field ID is from 60 (0x3c) to 63 (0x3f), the instrument triggers based on the calculated result of the classic checksum.
Sync	If the synch field is not 0x55, the instrument triggers on the synch field's stop bit position.
Timeout	The instrument triggers if any of the following three errors occurs. Slave Not Responding Error: After a break detection, if the frame is not finished before the time determined by the following equation elapses, the instrument triggers. $1.4 \times (T_{Header}^2 + T_{Response}^3)$ Header Timeout Error: After a break detection, if the header is not finished before the time determined by the following equation elapses, the instrument triggers. $1.4 \times T_{Header}^2$ Response Timeout Error: After a break detection, if the response is not finished before the time determined by the following equation elapses, the instrument triggers. $1.4 \times T_{Response}^3$
Framing	When a low-level stop bit is detected in the field, data, or checksum, the instrument triggers. The instrument may trigger if it detects a break and synch field in the middle of a frame.

- 1 If the value exceeds 255, it is carried over.
- 2 Nominal header length $T_{Header} = 34 \times T_{bit}^4$
- 3 Nominal response length $T_{Response} = 10 \times (N + 1) \times T_{bit}^4$ (N: data length)
- 4 Nominal time needed to transmit one bit defined in the physical layer.

Executing a Search (Search)

The instrument searches for locations where the specified search conditions are met. Then, the instrument displays the frame corresponding to the specified detected point number (Pattern No) expanded in the zoom window.

Detected Points

The detected points are the same as the trigger points.

▶ [See here.](#)

Jumping to the Specified Field (Field Jump)

The instrument searches for locations where the specified search conditions are met. Then, the instrument displays the frame corresponding to the specified detected point number (Pattern No.) expanded in the zoom window.

Break, Synch, ID, Data, CheckSum

Analyzing and Searching CXPI Bus Signals (Option)

Analysis Source

Normal frames, long frames (burst frames), sleep frames, wakeup pulses, wakeup state, sleep state

For the CXPI frame format, see “[CXPI Bus Trigger](#)” in chapter 4, “Triggering.”

Bus Setup (Setup)

Source (Source)

Set the analysis source to one of the settings below.

CH1 to CH4,* Math1 to Math4

* You can select CH4 when the key is illuminated.

Bit Rate (Bit Rate)

Select the CXPI bus signal's data transfer rate from one of the settings below.

4800 bps, 9600 bps, 19200 bps, User Define

If you select User Define, set the transfer rate in the range of 4000 bps to 50000 bps in 10-bps steps.

T Sample(T Sample)

Set the sum value, T Sample, for determining the logical value of the current bit.

The value in which T Sample is added to the low width of logical value 1 detected with the last bit is used as the threshold to determine the value as follows:

- Logical value 1 when the low width of the current bit is less than or equal to the threshold
- Logical value 0 when the low width of the current bit is greater than the threshold

Selectable range: 0.010 Tbit to 0.300 Tbit

Resolution: 0.001 Tbit

* Tbit is the time width of a bit calculated from the bit rate.

Clock Tolerance(Clock Tolerance)

Set the tolerance of the clock width calculated from the bit rate.

Selectable range: $\pm 0.5\%$ to $\pm 5.0\%$

Resolution: 0.1%

Counter Error Detection (Counter Error Detection)

Set whether to detect counter errors.

- ON: Counter errors are detected.
- OFF: Counter errors are not detected.

Level (Level) and Hysteresis (Hys)

You can set the level and hysteresis for detecting the signal high and low states. These items are the same as those of the edge search.

▶ [See here.](#)

Auto Setup (Auto Setup)

Executes auto setup based on the specified sources.

The auto setup feature automatically configures the bit rate, level, and hysteresis and triggers on the start of frame (SOF) of the CXPI bus signal. You cannot execute auto setup if the source is set to Math1 to Math4.

Decoded Display (Decode)

The colors that are used for the fields in the decoded display are as follows:

PTYPE	Pink (Pink)
ID	Light green (Light Green)
DLC, extension DLC*	Pink (Pink)
CT	Orange (Orange)
NM(Sleep.ind/ Wakeup.ind)	Yellow (Yellow)
Data	Cyan (Cyan)
CRC	Light blue (Light Blue)
Parity	Yellow (Yellow)
Start Bit	Gray (Gray) fill
Stop Bit	Gray (Gray) fill
IBS	Gray (Gray) fill
Wakeup pulse	Green (Green)
Error	Red (Red)

Parity Error, CRC Error, Counter (CT) Error:

Characters in the parity, CRC, or CT field in which an error occurred are displayed in black on a red background.

Data Length Error:

When the data length is less than DLC, characters in the DLC field is displayed in black on a red background.

When the data length is greater than DLC, characters in the exceeded field is displayed in black on a red background.

Framing Error:

“Framing Error” is displayed in black on a red background in the field after the error occurrence.

IBS Error:

“IBS Error” is displayed in black on a red background in the IBS field.

Clock Error:

“•••” is displayed in black on a red background in the field that the error occurred in.

* Extension DLC applies to long frames.

List Display (List/Trend - Show List)

The list displays the following items.

No.	Analysis number. Negative numbers are assigned to frames before the and positive numbers are assigned to frames after the trigger position.* The instrument can display the analysis results for up to 10000 frames in the range of -9999 to 9999. Pressing the RESET key highlights frame number zero.
Time(ms)	Displays the time from the trigger position* to the start of the frame in milliseconds.
ID	Displays the ID value in hexadecimal notation. If there is a PTYPE Field, "P" is displayed in front of the ID value.
DLC	Displays the DLC value in decimal notation. For long frames, the character "L" is followed by the extension DLC value in decimal notation.
W/S	Displays the wakeup indicator and then the sleep indicator in binary notation.
CT	Displays the counter value in decimal notation.
Data	Displays the data in hexadecimal notation. 12 bytes of data is displayed in each row.
CRC	Displays the CRC value in hexadecimal notation.
Information	Displays the following information. Wakeup, Wakeup Pulse, Sleep, Sleep Frame, errors If multiple errors are detected in a frame, up to two errors are displayed in the following order. PTYPE-Parity Error, ID-Parity Error, CRC Error, Data Length Error, Framing Error, IBS Error, Clock Error, Counter Error

* If [delay cancel \(Delay Cancel\)](#) is set to OFF, they are based on the trigger point.

Search Setup (Search)

Search Type (Mode)

Select the CXPI bus signal search type from one of the settings below.

- SOF: Searches for the start-of-frame position
- Error: Searches for errors
- [PTYPE](#): Searches for PTYPE
- [ID/Data](#): Searches for the position where the AND condition of the ID bit pattern, frame information, and data pattern is met
- [Wakeup/Sleep](#): Searches for wakeup pulses, wakeup states, sleep frames, and sleep states

SOF(Start of Frame)

The instrument searches for the start position of CXPI bus signal frames.

Error

The instrument searches for various errors.

- **Error Type (Error Type OR)**

Parity	When a parity error is detected
CRC	When a CRC error is detected
Data Length	When the DLC value and the number of data pieces in the data field (data length) do not match
Framing	When the logical value of the stop bit of a field or the stop bit of data is 0
IBS	When the number of IBS bits is 10 or more
Counter	When a counter error is detected (can be set as a search item when the counter error detection is set to ON)
Clock	When the clock width exceeds the specified tolerance

15 Analyzing and Searching Serial Bus Signals

PTYPE

The instrument searches for PTYPE.

- **Search Conditions (Condition)**

Every PTYPE	When PTYPE is detected
No Response	When PID is not detected after PTYPE

ID/Data

The instrument searches normal, long, and sleep frames.

The instrument searches on the AND of SOF, ID, frame information, and data conditions.



- If you specify X in the ID bit pattern, frame information, or data pattern, the condition is assumed to be met regardless of the corresponding bit or item status.
 - In a bit pattern or data pattern setting, if a binary pattern contains any Xs, the corresponding hexadecimal display will be "\$."
-

- **Search Conditions (Condition Setup)**

On the Condition Setup screen, set the search conditions such as the ID, frame information, and data.

SOF

When the start of a CXPI bus signal frame is detected when the search condition is set to SOF only, the instrument detects it as a detected point. SOF of ID/Data is always selected as a search condition.

ID

with PTYPE

Whether the frame contains PTYPE is used as a search condition.

- Yes: Detects the ID of frames containing PTYPE
- No: Detects the ID of frames not containing PTYPE
- X: Detects the ID regardless of the presence of PTYPE

Bit Pattern (Hex/Bin)

Set the 7-bit ID bit pattern in hexadecimal (Hex) or binary (Bin) notation. The ID search condition is met when the input signal ID bit pattern matches the specified bit pattern.

Frame Information

The wakeup and sleep indicators of frame information and CT bit value are used as search conditions.

- Wakeup: Set the wakeup indicator bit value to 0, 1, or X.
- Sleep: Set the sleep indicator bit value to 0, 1, or X.
- CT: Set the counter bit value to a value from 0 to 3 or X.

Data

You can set a search condition based on the data value. Specify the size, position, condition, and data pattern settings.

Comparison Size (Size)

Set the data length to be compared. The data pattern with the specified data length is compared to the input signal data pattern. If "0" is specified, the instrument assumes that a point has been detected regardless of the input signal's data value.

Selectable range: 0 to 8 bytes

Comparison Start Position (Position)

Set the position to start comparing the data pattern. The left end of the data is position 0.

Selectable range: 0 to 254 bytes



- If the comparison size (Size) is set to 0, comparison start position (Position) cannot be set.
- The selectable range for position is limited so that Size + Position is less than or equal to 255.

Comparison Condition (Condition)

The data search condition is met when the result of comparing the data pattern or reference value to the input signal's data meets the specified comparison condition.

True	When the value matches the data pattern
False	When the value does not match the data pattern
Data=a ¹	When the value is equal to the reference value
Data≠a ¹	When the value is not equal to the reference value
a≤Data ¹	When the value is greater than or equal to the reference value
Data≤b ¹	When the value is less than or equal to the reference value
a≤Data≤b ²	When the value is within the reference range (including the reference values)
Data<a, b<Data ²	When the value is outside the reference range (excluding the reference values)

1 Set one reference value

2 Set two reference values

Data Pattern (Hex/Bin)

If the comparison condition is set to True or False, set the data pattern for the specified size in hexadecimal (Hex) or binary (Bin) notation.

Reference Values (a and b)

If the comparison condition is set to Data = A, Data ≠ a, a ≤ Data, Data ≤ b, a ≤ Data ≤ b, or "Data < a or b < Data," set the reference values in decimal notation. You must set the byte order (Endian), sign (Sign), and comparison range (MSB or LSB).

The selectable ranges are as follows:

Unsigned (Unsign)	0 to 9E+18 The selectable maximum value is limited by the data length and bit position, which are determined by the Size and MSB/LSB settings, respectively.
Signed (Sign)	-9E+18 to 9E+18 The selectable minimum and maximum values are limited by the data length and bit position, which are determined by the Size and MSB/LSB settings, respectively.

The value is displayed in scientific notation when the number of digits exceed seven (example: 1234567E+10).



If the comparison condition is $a \leq \text{Data} \leq b$ or “Data < a or b < Data,” the two reference values are automatically adjusted so that the lower limit is less than or equal to the upper limit.

Byte Order (Endian), Sign (Sign), and Comparison Range (MSB/LSB)

These items are the same as those of the CAN bus trigger.

▶ [See here.](#)

Wakeup/Sleep

The instrument searches for wakeup pulses, wakeup states, sleep frames, or sleep states.

- **Wakeup/Sleep Type OR**

Wakeup Pulse	When a pulse in the dominant period between 250 μs and 2500 μs is detected
Wakeup	When a transition from a state in which there is no clock after a sleep detection to a state in which there is a clock is detected
Sleep Frame	When the sleep frame ID value is 1F (hexadecimal)
Sleep	When 5 ms elapses after a transition is made from a state in which there is a clock to a state in which there is no clock

Executing a Search (Search)

The instrument searches for locations where the specified search conditions are met. Then, the instrument displays the specified detected point number (Pattern No) expanded in the zoom window.

Detected Points

The detected points are the same as the trigger points.

▶ [See here.](#)

Analyzing and Searching SENT Signals (Option)

Analysis Source

Fast channel and slow channel of SENT signals

For the SENT frame format, see “[SENT Trigger](#)” in chapter 4, “Triggering.”

Bus Setup (Setup)

Source (Source)

Set the analysis source to one of the settings below.

CH1 to CH4/LOGIC,* Math1 to Math4

- * CH4 or LOGIC, whichever the corresponding key is illuminated, can be selected. If you select LOGIC, select the source bit (bit 0 to bit 7).

Format (Format)

This item is the same as that of Version, Clock Tick, Clock Tolerance, Data Nibbles, Pause Pulse, CRC Type, and Customize Error Factor of the SENT signal trigger.

▶ [See here.](#)

Display Channel (Display)

Select the channel to be decoded and listed from one of the settings below.

- Both: Both fast channel and slow channel are displayed.
- Fast CH: Fast channel is displayed.
- Slow CH: Slow channel is displayed.

Fast Channel Data Type (Fast CH_Data Type)

Select the fast channel data display method from one of the settings below.

Nibble: Set a 4 to 24 bit data pattern in unit of nibbles (4 bits).

User: Set the data sizes of Data1 to Data4 in the range of 0 to 24 bits.

- Select whether or not to display Data1 to Data4.
- The total number of bits for Data1 to Data4 is up to 24. If you try to exceed the total number of bits, the data size of other pieces of Data is reduced. If as a result of executing auto setup (explained later), the number of data nibbles in the input SENT signal is less than six, the total number of bits that can be specified is up to (the number of data bits) × 4.
- Set the nibble order (Order) to Big or Little.

Slow CH Type (Slow CH Type)

Select the slow channel message type from one of the settings below. This is selectable when the format version (explained earlier) is APR2016 or JAN2010.

- Short: Short message
- Enhanced: Enhanced message

Level (Level) and Hysteresis (Hys)

These items are the same as those of the edge search.

▶ [See here.](#)

Auto Setup (Auto Setup)

Executes auto setup based on the specified sources.

The auto setup feature automatically configures the format, level, and hysteresis and then triggers at the end of SYNC/CAL of the fast channel. You cannot execute auto setup when:

- The sources is set to Math1 to Math4.
- State display is applied to a LOGIC bit that is set as the source.

Decoded Display (Decode)

The colors that are used for the fields in the decoded display are as follows:

Fast CH

SYNC/CAL	Pink (Pink)
S&C	Yellow (Yellow)
Data	Cyan (Cyan)
CRC	Light blue (Light Blue)
Pause	Orange (Orange)
Error	Red (Red) Depending on the error type, the red area is applied as follows: Successive CAL Pulses: SYNC/CAL field Nibble Number: Entire frame Nibble Data Value: Nibble of the relevant data Fast CH CRC: CRC Field Status and Communication(S&C): S&C Field

Slow CH

ID	Light green (Light Green)
Data	Cyan (Cyan)
CRC	Light blue (Light Blue)
Error	Red (Red) Depending on the error type, the red area is applied as follows: Error present in the corresponding fast channel: Frame borders Slow CH CRC: CRC background and frame borders

List Display (List/Trend - List)

The list displays the following items.

Fast CH

No.	Analysis number. Negative numbers are assigned to frames before the and positive numbers are assigned to frames after the trigger position.* The instrument can display the analysis results for up to 100000 frames in the range of -99999 to 99999. Pressing the RESET key highlights frame number zero.
Time(ms)	Displays the time from the trigger position* to the start of the frame in milliseconds.
Sync(μs)	Displays the time period of the SYNC/CAL field.
Tick(μs)	Displays the time period of a clock tick.
S&C	Displays the time period of the S&C field.
Data	Displays data in hexadecimal or decimal notation.
CRC	Displays the CRC value in hexadecimal or decimal notation.
Length(tick)	Displays the frame length.
Information	Displays the following error information. If multiple errors are detected in a frame, the instrument displays a single error in the following order of precedence. Successive CAL Pulses, Nibble Number, Nibble Data Value, Fast CH CRC, Status and Communication(S&C)
Slow CH	This item is displayed when the display channel (Display) is set to Both. It displays the slow channel information. The corresponding fast channel is enclosed with <START> and <END> tags.

* If [delay cancel \(Delay Cancel\)](#) is set to OFF, they are based on the trigger point.

Slow CH

No.	Analysis number. Negative numbers are assigned to frames before the and positive numbers are assigned to frames after the trigger position.* The instrument can display the analysis results for up to 100000 frames in the range of -99999 to 99999. Pressing the RESET key highlights frame number zero.
Time(ms)	Displays the time from the trigger position* to the start of the frame in milliseconds.
ID	Displays message ID in hexadecimal or decimal notation.
Data	Displays data in hexadecimal or decimal notation.
CRC	Displays the CRC value in hexadecimal or decimal notation.
Information	Displays the following error information. If multiple errors are detected in a frame, the instrument displays a single error in the following order of precedence. Fast CH Error, CRC Error

* If [delay cancel \(Delay Cancel\)](#) is set to OFF, they are based on the trigger point.

Trend Display (List/Trend - Trend)

Up to four trends (Trend1 to Trend4) of decoded data can be displayed. You can also display the data values using the cursor measurement function.

Trend Display (Display)

Set whether or not to display the trend. The trend is displayed in the Trend window. The trend is not displayed for data of messages that contain errors. Such areas become blank.

- ON: The trend is displayed.
- OFF: The trend is not displayed.

Display Source (Source)

Select the channel to display the trend of from one of the settings below.

- Fast CH: The trend of the fast channel is displayed.
- Slow CH: The trend of the slow channel is displayed.

User Data(User Data)

When the display source is fast channel, select the user data you want to display the trend of. Set the size and order of user data using the fast channel data type menu in the bus setup menu. ► [See here.](#)

Selectable range: 1 to 4

(2 to 4 when the version is APR2016 and multiplexing is set to on)

Slow CH ID(Slow CH ID)

When the display source is slow channel, set the message ID of the data you want to display the trend of. The selectable range of ID varies depending on the type selected in the slow channel message type menu

(► [See here.](#)).

Message type	Short		Enhanced	
	Hex	Dec	Hex	Dec
Selectable range	0 to F	0 to 15	00 to FF	0 to 255

Configuring the Display (Display Setup)

Set the trend display scale, and turn the display of VT waveforms on or off.

- **Auto Scale Exec**

Executes auto scaling. The upper and lower limits are set so that the difference between the maximum data value and minimum data value in the window selected with H-Range covers 80% of the vertical scale of the Trend window.

- **H-Range**

Select the range to display the trend of from the following windows.

Main: Main window

Zoom1: Zoom1 window

Zoom2: Zoom2 window

- **VT Display**

Select whether to display the VT waveform along with the trend display.

ON: Displays the VT waveform display window

OFF: Does not display the VT waveform display window

- **Upper/Lower**

Set the vertical scale values of the trend display.

- **Cursor Measurement (Cursor)**

You can perform cursor measurement on the trend.

ON: Cursor1 and Cursor2 values are measured.

OFF: Cursor measurement is not performed.

T1	Time value of Cursor1 (time from the trigger position*)
T2	Time value of Cursor2 (time from the trigger position*)
ΔT	Difference between the time values of Cursor1 and Cursor2
V1(TRx)	Data value at the intersection of Cursor1 and trend (Trend) x
V2(TRx)	Data value at the intersection of Cursor2 and trend (Trend) x
$\Delta V(TRx)$	Difference between the data values at the intersection of Cursor1 and trend (Trend) x and the intersection of Cursor2 and trend (Trend)

* If **delay cancel (Delay Cancel)** is set to OFF, they are based on the trigger point.

x: 1 to 4

Search Setup (Search)

Search Type (Mode)

Select the SENT signal search type from one of the settings below.

- Every Fast CH: Searches for fast channel messages
- Fast CH S&C: Searches for the status and communication bit pattern
- Fast CH Data: Searches for the position where the AND condition of the fast channel data is met
- Every Slow CH: Searches for slow channel messages
- Slow CH ID/Data: Searches for the position where the AND condition of the slow channel ID and data is met
- Error: Searches for errors

The method to set search conditions is the same as that for the trigger conditions of the SENT trigger. Set the ID and data using the format selected in the decode menu.

▶ [See here.](#)

Executing a Search (Search)

The instrument searches for locations where the specified search conditions are met. Then, the instrument displays the specified detected point number (Pattern No) expanded in the zoom window.

Detected Points

For the positions of detected points, see appendix 6.

▶ [See here.](#)

Analyzing and Searching UART Signals (Option)

Analysis Source

Data: Searches for data patterns

For the UART data format, see “[UART Trigger](#)” in chapter 4, “Triggering.”

Bus Setup (Setup)

Source (Source)

Set the analysis source to one of the settings below.

CH1 to CH4/LOGIC,* Math1 to Math4

* CH4 or LOGIC, whichever the corresponding key is illuminated, can be selected. If you select LOGIC, select the source bit (bit 0 to bit 7).

Bit Rate (Bit Rate)

Select the UART signal’s data transfer rate from one of the settings below.

1200 bps, 2400 bps, 4800 bps, 9600 bps, 19200 bps, 38400 bps, 57600 bps, 115200 bps, User Define

If you select User Define, set the transfer rate in the range of 1000 bps to 10000000 bps in 100-bps steps.

Bit Order (Bit Order) and Polarity (Polarity)

These items are the same as those of the UART signal.

▶ [See here.](#)

Sample Point (Sample Point)

You can set the reference that will be used to determine the signal level in the range of 18.8 to 90.6% in 3.1% steps.

Data Format (Format)

Select from the following.

- 8 bit No Parity: 8-bit data (no parity bit)
- 7 bit Parity: 7-bit data + parity bit
- 8 bit Parity: 8-bit data + parity bit

Parity (Parity)

Set the parity bit to even (Even) or odd (Odd).

Grouping (Grouping)

Select whether or not to group data when displaying the list of decoded results. When you turn grouping on, data whose time is shorter than the specified byte space (Byte Space) is decoded and displayed in a single group.

- OFF: Does not group the list of decoded results
- ON: Groups the list of decoded results

- **Byte Space (Byte Space)**

The instrument displays data whose time length is less than the specified byte space (Byte Space) in a single group.

Selectable Range

The selectable range is from the time length that corresponds to the number of bits in the UART signal data format plus 2 bits, to 100 ms.

The “2 bits” that are added are the start and stop bits.

For example, if the data format is 8 bits with a parity bit, the time length is as follows:

Data (8) + parity bit (1) + start bit (1) + stop bit (1) = Time length for 11 bits

Resolution: 1 μ s

Default value: Time length that corresponds to the number of bits in the UART signal data format and 2 bits

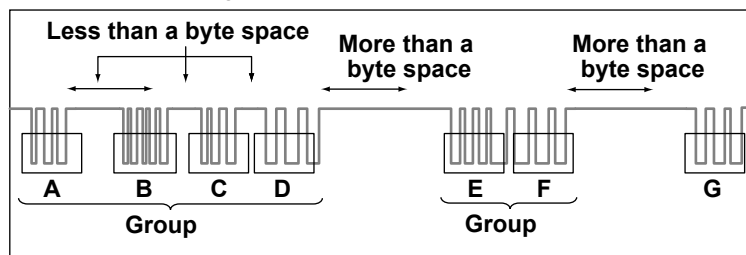

Level (Level) and Hysteresis (Hys)

These items are the same as those of the edge search.

▶ [See here.](#)

Auto Setup (Auto Setup)

Executes auto setup based on the specified sources.

The auto setup feature automatically configures the bit rate, sample point, level, and hysteresis and then triggers on the UART signal's Stop Bit. You cannot execute auto setup when:

- The sources is set to Math1 to Math4.
- State display is applied to a LOGIC bit that is set as the source.

Decoded Display (Decode)

The colors that are used for the fields in the decoded display are as follows:

Data	Cyan (Cyan)
Parity	Yellow (Yellow)
Start Bit	Gray (Gray) fill
Stop Bit	Gray (Gray) fill
Error	Red (Red)
	Framing Error: Displays the words “Framing Error” in the field in which an error occurred using black characters on red background. It is displayed with higher precedence than a parity error.
	Parity Error: Displays the characters of the field in which an error occurred using black characters on red background.

List Display (List)

The list displays the following items.

When Grouping Is Set to ON

No.	Analysis number. Negative numbers are assigned to frames before the and positive numbers are assigned to frames after the trigger position.* The instrument can display the analysis results for up to 300000 frames in the range of -299999 to 299999. Pressing the RESET key highlights data number zero.
Time(ms)	Displays the time from the trigger position* to the start of the byte in milliseconds.
Data	Displays the first 16 bytes of data for each group in hexadecimal notation and ASCII codes. You can press the Detail soft key to view all of the data of the specified group (analysis number).
Information	Displays the following error information. If multiple errors are detected in one piece of data, the instrument only displays the framing error indication. Framing Error, Parity Error

* If [delay cancel \(Delay Cancel\)](#) is set to OFF, they are based on the trigger point.

When Grouping Is Set to OFF

Addr	Displays the address relative to the first data address.
Hex	Displays the data in hexadecimal notation. An asterisk or an "X" is attached to the data if a framing error or a parity error is detected, respectively.
Ascii	Displays the data using ASCII codes.

Search Setup (Search)

Search Type (Mode)

Select the UART signal search type from one of the settings below.

- Every Data: Searches for data stop bits
- Error: Searches for errors
- Data: Searches for data patterns

The method to set search conditions is the same as that for the trigger conditions of the UART trigger.

▶ [See here.](#)

Executing a Search (Search)

The instrument searches for locations where the specified search conditions are met. Then, the instrument displays the specified detected point number (Pattern No) expanded in the zoom window.

Detected Points

The detected points are the same as the trigger points.

▶ [See here.](#)

Analyzing and Searching I²C Bus Signals (Option)

For the I²C data format, see “I²C Bus Trigger” in chapter 4, “Triggering.”

Bus Setup (Setup)

Serial Clock (SCL), Serial Data (SDA)

Set the SCL and SDA sources to one of the settings below.

CH1 to CH4/LOGIC,* Math1 to Math4

- * CH4 or LOGIC, whichever the corresponding key is illuminated, can be selected. If you select LOGIC, select the source bit (bit 0 to bit 7).

Level (Level) and Hysteresis (Hys)

These items are the same as those of the edge search.

▶ [See here.](#)

Auto Setup (Auto Setup)

Executes auto setup based on the specified SCL and SDA sources.

The instrument sets the level and hysteresis and triggers on the start condition of the I²C bus signal.

You cannot execute auto setup when:

- SCL or SDA source is set to Math1 to Math4.
- State display is applied to a LOGIC bit set as the SCL or SDA source.

R/W Bit Inclusion (Include R/W)

When you set the address pattern input format to hexadecimal, you can choose to include or omit the R/W bit when you set the address pattern.

- ON: Include the R/W bit (address + R/W bit: hexadecimal)
- OFF: Omit the R/W bit (address: hexadecimal, R/W bit: binary)

▶ [See here.](#)

Decoded Display (Decode)

The colors that are used for the fields in the decoded display are as follows:

Start/Restart Condition	Light gray (Light Gray)
Adr	Light green (Light Green)
Data	Cyan (Cyan)
R/W	Pink (Pink)
Ack	Yellow (Yellow)
General Call	Green (Green)
Start Byte	Orange (Orange)
HS Mode	Orange (Orange)
Stop Condition	Light gray (Light Gray)

You can select whether to show or hide Start/Restart Condition and Stop Condition.

▶ [See here.](#)

List Display (List)

The list displays the following items.

No.	Analysis number. Negative numbers are assigned to frames before the and positive numbers are assigned to frames after the trigger position. ¹ The instrument can display the analysis results for up to 300000 frames in the range of -299999 to 299999. Pressing the RESET key highlights data number zero.
Time(ms)	Displays the time from the trigger position ¹ to the start of the byte in milliseconds.
1st ²	Displays the first byte address in hexadecimal notation.
2nd ²	Displays the second byte address in hexadecimal notation.
R/W	Displays the signal type. R: Read, W: Write
Data	Displays the data in hexadecimal notation. The first 16 bytes are displayed. You can press the Detail soft key to view all of the data of the specified analysis numbers.
ACK	If an Acknowledge bit is detected, the instrument displays an asterisk by the Data column.
Information	Displays the data type. general call, Start byte, Hs-mode, 10-bit, 7-bit, CBus

1 If [delay cancel \(Delay Cancel\)](#) is set to OFF, they are based on the trigger point.

2 You can use the R/W bit inclusion setting (Include R/W) to choose whether or not to include the R/W bit in the displayed address.

Search Setup (Search)

Search Type (Mode)

I²C bus signal search type from one of the settings below and set the search conditions.

- Every Start: Searches for start and restart conditions
- Adr Data: Searches for address patterns and data patterns (AND condition)
- NON ACK: Searches for NACK (SDA is H) acknowledge bits.
- General Call: Searches for general call addresses
- Start Byte: Searches for the master codes of start bytes
- HS Mode: Searches for the master codes of HS modes

The method to set search conditions is the same as that for the trigger conditions of the I²C bus trigger.

▶ [See here.](#)

Executing a Search (Search)

The instrument searches for locations where the specified search conditions are met. Then, the instrument displays the specified detected point number (Pattern No) expanded in the zoom window.

Detected Points

The detected points are the same as the trigger points.

▶ [See here.](#)

Analyzing and Searching SPI Bus Signals (Option)

For the SPI time chart, see “[SPI Bus Trigger](#)” in chapter 4, “Triggering.”

Bus Setup (Setup)

Wiring system (Mode)

This item is the same as that of the SPI bus signal.

▶ [See here.](#)

Bit Order (Bit Order)

This item is the same as that of the SPI bus signal.

▶ [See here.](#)

Clock (Clock), Data1 (Data1), Data2 (Data2), and Chip Select (CS (SS))

Set the clock, Data1, Data2, and chip select sources from the available waveforms below.

CH1 to CH4/LOGIC,¹ Math1 to Math4, or None (Don't care)²

- 1 CH4 or LOGIC, whichever the corresponding key is illuminated, can be selected. If you select LOGIC, select the source bit (bit 0 to bit 7).
- 2 Only selectable for the chip select source. If you select None, set grouping to ON or OFF and the idle time (Idle Time).

Clock Idle Time and Grouping (Idle time/Grouping)

When Grouping is set to ON, the decoded results are displayed starting from the first rising or falling clock edge after the specified idle time. When Grouping is set to OFF, the data is decoded from the left of the screen, regardless of the idle time setting.

You can turn grouping on and off and set the idle time when CS (SS) is set to None (don't care).

Clock Polarity (Polarity) and Chip Select Active State (Active)

These items are the same as those of the SPI Bus trigger.

▶ [See here.](#)

Level (Level) and Hysteresis (Hys)

These items are the same as those of the edge search.

▶ [See here.](#)

Auto Setup (Auto Setup)

Executes auto setup based on the specified wiring system and the clock, Data1, Data2, and chip select sources.

The auto setup feature automatically configures the level and hysteresis, and triggers on the SPI signal's first data byte.

You cannot execute auto setup when:

- Any of the sources (i.e., clock, Data1, Data2, or chip select) is set to Math1 to Math4.
- State display is applied to any of the LOGIC bits set at the clock, Data1, Data2, or chip select.
- The chip select source is set to None (Don't care).

Decoded Display (Decode)

The colors that are used for the fields in the decoded display are as follows:

Data	Cyan (Cyan)
Group background	Gray (Gray)

List Display (List)

The list displays the following items.

No.	Analysis number. Negative numbers are assigned to frames before the and positive numbers are assigned to frames after the trigger position (reference point). ¹ The instrument can display the analysis results for up to 300000 frames in the range of -299999 to 299999. Pressing the RESET key highlights data number zero.
Time(ms)	Displays the time from the trigger position ¹ to the start of the byte in milliseconds.
Data1 ²	Displays Data1 in hexadecimal notation.
Data2 ²	Displays Data2 in hexadecimal notation. Only for four-wire systems.

- 1 If [delay cancel \(Delay Cancel\)](#) is set to OFF, they are based on the trigger point.
- 2 The first 16 bytes are displayed. You can press the Detail soft key to view all of the data of the specified analysis numbers.

Search Setup (Search)

When the wiring system is 3wire, the instrument searches Data1 for the specified condition (data pattern). When the wiring system is 4wire, the instrument searches Data1 and Data2 for the specified condition (data pattern).

Search Conditions (Condition Setup)

These conditions are the same as the SPI bus trigger conditions.

▶ [See here.](#)

Executing a Search (Search)

The instrument searches for locations where the specified search conditions are met. Then, the instrument displays the specified detected point number (Pattern No) expanded in the zoom window.

Detected Points

The detected points are the same as the trigger points.

▶ [See here.](#)

Analyzing and Searching User-Defined Serial Bus Signals (User Define)

Bus Setup (Setup)

You must set the following items to analyze user-defined serial bus signals.

Source (Source)

Set the analysis source to one of the settings below. The available settings vary depending on the model.

CH1 to CH4,* Math1 to Math4

* You can select CH4 when the key is illuminated.

Set the selected source's active state, and level.

This item is the same as the trigger of a user-defined serial bus signal.

▶ [See here.](#)

Level (Level) and Hysteresis (Hysteresis)

Set the level and hysteresis used to detect the source state.

These items are the same as those of the edge search.

▶ [See here.](#)

Clock (Clock)

You can select whether or not to sample the data source in sync with the clock source.

- ON: Samples the data source in sync with the clock source
- OFF: Samples the data source according to the bit rate.

If you select ON, set the clock source (Clock), enable source (Enable), and latch source (Latch). You cannot specify an enable or latch source on 2-channel models.

This item is the same as the trigger of a user-defined serial bus signal.

▶ [See here.](#)

Bit Rate (Bit Rate)

The instrument samples the data source at the specified bit rate. Set the bit rate when the clock is OFF.

Selectable Range	1000 bps to 50 Mbps
Setting resolution	0.001 kbps (for 1.000 kbps to 99.999 kbps) 0.01 kbps (for 100.00 kbps to 999.99 kbps) 0.1 kbps (for 1 Mbps to 9999.9 kbps) 1 kbps (for 10 Mbps to 50 Mbps)

Decoding Start Point (Start Point)

Set the decoding start point.

Decoded Display (Decode)

The colors that are used for the fields in the decoded display are as follows: The decoded display can only be used when the clock is not used.

Data: Cyan (Cyan)

Search Setup (Search)

Search Conditions (Condition Setup)

The method of setting search conditions is the same as that of setting the user-defined serial bus signal trigger conditions.

▶ [See here.](#)

Executing a Search (Search)

The instrument searches for locations where the specified search conditions are met. Then, the instrument displays the specified detected point number (Pattern No) expanded in the zoom window.

Detected Points

The detected points are the same as the trigger points.

▶ [See here.](#)

16 Waveform Histogram Display

The instrument can count the frequency of data occurrence in a specified area and display in a histogram. You can select whether to count the voltage data frequency or the time data frequency.

You can measure the mean, standard deviation, maximum value, minimum value, peak value, median, etc.

You can configure up to two histogram source waveforms (Select1, Select2).*

* Only Select1 on the 2-channel model.

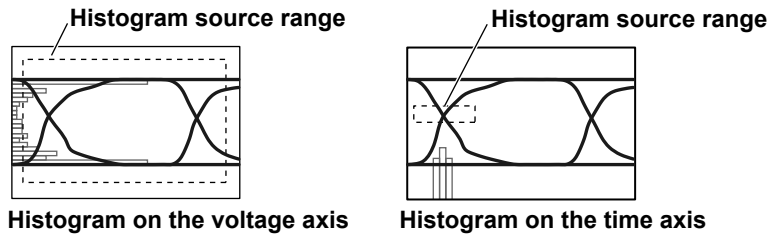

Histogram on the voltage axis

Histogram on the time axis

Turning the Histograms On or Off (Display)

Sets whether or not to display histograms for Select1 and Select2.

- OFF: Hides the histograms
- ON: Displays the histograms

Source Waveform (Trace)

Select the source waveform from the waveforms below. The available settings vary depending on the model. CH1 to CH4, Math1 to Math4

Source Axis (Type)

Selects the data axis that you want to count the frequency for.

- Vertical: Vertical axis
- Horizontal: Time axis

Range Setup (Range Setup)

Source Window (Range)

Selects the window that you want to count the frequency in.

- Main: Main window
- Zoom1: Zoom1 window
- Zoom2: Zoom2 window

Upper and Lower Range Limits (Upper/Lower)

Sets the upper and lower limits within which frequencies are counted in the range of ± 4 divisions.

Left and Right Range Values (Left/Right)

Sets the left and right boundaries within which frequencies are counted in the range of ± 4 divisions.

Histogram Frequency

The frequency of values is counted until the waveform display is updated. The frequency is reset when the waveform display is updated.

Measurement (Measure Setup)

Mode (Mode)

OFF: Disables measurement.

Param: Measures the value of the selected parameter and performs cursor measurement.

Cursor Measurement (Cursor1 and Cursor2)

Measurement items C1, C2, and ΔC are used to measure the Cursor1 value, the Cursor2 value, and the difference between the two cursor values. The selectable range varies depending on the source axis as follows:

- If the source axis is vertical (Cursor1 =, Cursor2 =): In the range of ± 4 divisions of the vertical axis
- If the source axis is horizontal (Cursor1 II, Cursor2 II): In the range of ± 4 divisions of the time axis

Measurement Items (Item)

The instrument measures the values of the items listed below that you select.

Peak	Peak value
Max	Maximum value
Min	Minimum value
Mean	Mean value
σ	Standard deviation of the histogram
Median	Median*
Integ $\pm\sigma$	Percentage of values that fall within $\pm\sigma$ (%)
Integ $\pm 2\sigma$	Percentage of values that fall within $\pm 2\sigma$ (%)
Integ $\pm 3\sigma$	Percentage of values that fall within $\pm 3\sigma$ (%)
C1	Cursor1 value
C2	Cursor2 value
ΔC	Difference between Cursor1 and Cursor2

* Re-sorts the sampled points from the minimum to the maximum value and determines the value of the middle number.

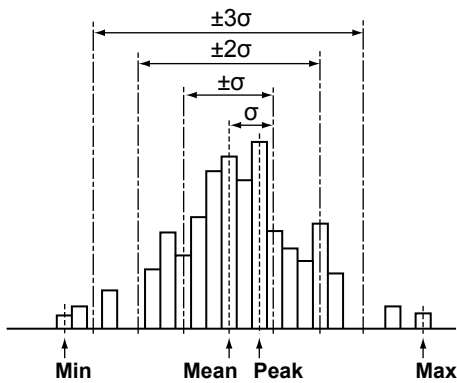

17 Power Supply Analysis Feature (Power Analysis and Power Measurement, Option)

Overview of the Power Supply Analysis Feature

The power supply analysis feature consists of analysis features such as switching loss analysis and power measurement features for voltage, current, and power. The power supply analysis option is only available on 4-channel models.

Power Analysis (Power Analysis)

Type (Type)

Select the power supply analysis type from one of the settings below.

- OFF: Disables power supply analysis
- [SW Loss](#): Switching loss analysis
- [SOA](#): Safe operating area analysis
- [Harmonics](#): Harmonic analysis
- $\int t$: Joule integral

Power Measurement (Power Measurement)

Power of up to two circuits (Power Measurement1 and Power Measurement2) can be measured simultaneously. For details, see "[Power Measurement \(Power Measurement\)](#)," provided later.

Deskewing the Transfer Time Difference between Analysis Source Signals

To correctly measure power supply analysis items from the voltage and current, you must apply the voltage and current signals to the instrument's signal input terminals with no transfer time difference between the signals. However, transfer time difference may occur between the two signals depending on the probe that you are using. The instrument allows you to automatically or manually deskew the transfer time difference between the two signals and then measure analysis items and power measurement items. To use this feature, you need to connect a deskew signal source along with the probe beforehand.

We recommend that you use the following YOKOGAWA products when you deskew the signals.

Deskew signal source	701936
Passive probe	701937
Differential probe	700924, 701921, 701926, 701927
Current probe	701928, 701929, 701930, 701931, 701932, 701933

Notes about Auto Deskewing

- Use the 701936 as the deskew signal source.
- Use a current probe whose attenuation is 10 A:1 V. When you use the 701936 deskew signal source, you can also use current probes whose attenuation is 100 A:1 V.
- There is a unique interval between the voltage and current output waveforms of the 701936 deskew signal source. This interval is a result of the electrical length and impedance of the signal output section. Because in auto deskew the unique value is corrected automatically, after auto deskew is performed, the voltage and current waveform values are off by the amount of the unique value. For information about the unique value and about manual skew correction, see the 701936 deskew signal source user's manual.



You need power supplies to use the deskew signal source and current and differential probes without the YOKOGAWA probe interface (differential probes can run on batteries). If the instrument is not equipped with the probe power option (/P4), you need to use the probe power supply (701934), which is sold separately.

Example of Deskewing

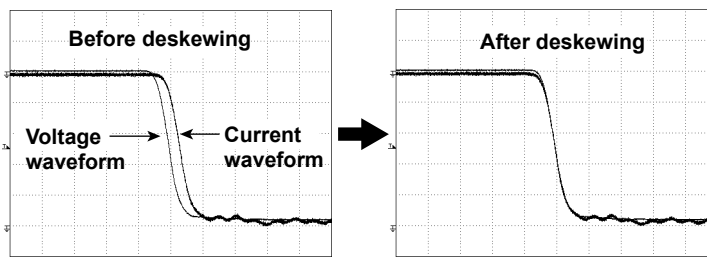

Switching Loss Analysis (SW Loss)

You can measure the device's total loss (power loss) and switching loss (power loss during switching). If you select SW Loss, you can calculate statistics and display power waveforms and measured values.



You can display a total of up to 20 switching loss measurement items and automatically measured waveform parameter items. If measured switching loss values are not displayed, reduce the number of automatically measured waveform parameter items.

▶ [See here.](#)

Probe Setup (ProbeSetup)

Selecting Channels (Input Channels)

Select CH1 and CH2 or CH3 and CH4. You cannot change these pairs.

To measure power supply analysis items, apply the voltage signal to CH1 or CH3 and the current signal to CH2 or CH4.

Probe Attenuation Ratio and Voltage-to-Current Conversion Ratio (Probe CH1/CH2 or Probe CH3/CH4)

Select one of the probe attenuation ratios (CH1 or CH3) and one of the voltage-to-current conversion ratios (CH2 or CH4) listed below.

- CH1, CH3
0.001:1, 0.002:1, 0.005:1, 0.01:1, 0.02:1, 0.05:1, 0.1:1, 0.2:1, 0.5:1, 1:1, 2:1, 5:1, 10:1, 20:1, 50:1, 100:1, 200:1, 500:1, 1000:1, 2000:1
- CH2, CH4
0.001 A: 1 V, 0.002 A: 1 V, 0.005 A: 1 V, 0.01 A: 1 V, 0.02 A: 1 V, 0.05 A: 1 V, 0.1 A: 1 V, 0.2 A: 1 V, 0.5 A: 1 V, 1 A: 1 V, 2 A: 1 V, 5 A: 1 V, 10 A: 1 V, 20 A: 1 V, 50 A: 1 V, 100 A: 1 V, 200 A: 1 V, 500 A: 1 V, 1000 A: 1 V, 2000 A: 1 V



Changing the probe attenuation ratio or voltage-to-current conversion ratio here will change the same ratio in the CH key probe settings.

Deskewing Manually (Deskew CH1/CH2 or Deskew CH3/CH4)

You can set values for deskewing the transfer time difference between signals on each channel.

Auto Deskew Reference Waveform (Ref Trace)

Sets the reference waveform for auto deskewing. The instrument deskews the input signals by using the specified waveform as its reference.

Auto Deskewing (Auto Deskew)

Executes auto deskewing.



You can also manually deskew the input signals by using the jog shuttle.

Measurement Setup (Measure Setup)

The loss of multiple cycles can be measured. The measurement time period is the range specified by the T Range1 and T Range2 cursors. The cycle is determined on the basis of the intersections of the mesial level and the voltage waveform. Then, the loss for multiple cycles is measured. The total loss that is corrected depending on the type of loss (described later) can also be measured.

$$\text{Loss} = \int_{Tc1}^{Tc2} u(t) \cdot i(t) dt \quad \text{Loss per unit time} = \frac{1}{Tc} \int_{Tc1}^{Tc2} u(t) \cdot i(t) dt$$

u(t): Sampled voltage data
i(t): Sampled current data

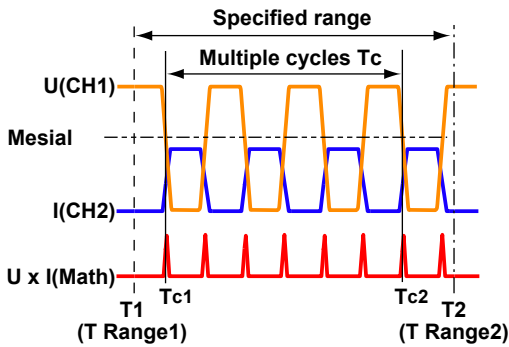

If the specified period does not contain one cycle of waveform, the measured value is displayed as "*****."

Type of Loss (Conduction Calc)

Select the type of loss to be measured from one of the settings below.

U x I: The loss according to the aforementioned equation.

RDS(on) x I²: The loss over the loss calculation period on the basis of the device's on-resistance, RDS(on).

VCE(sat) x I: The loss over the loss calculation period on the basis of the device's collector-emitter saturation voltage, Vce(SAT).

If the type of loss is set to RDS(on) x I² or VCE(sat) x I, the total loss is measured according to the following.

Total loss = Loss in the loss calculation period + loss in the switching period

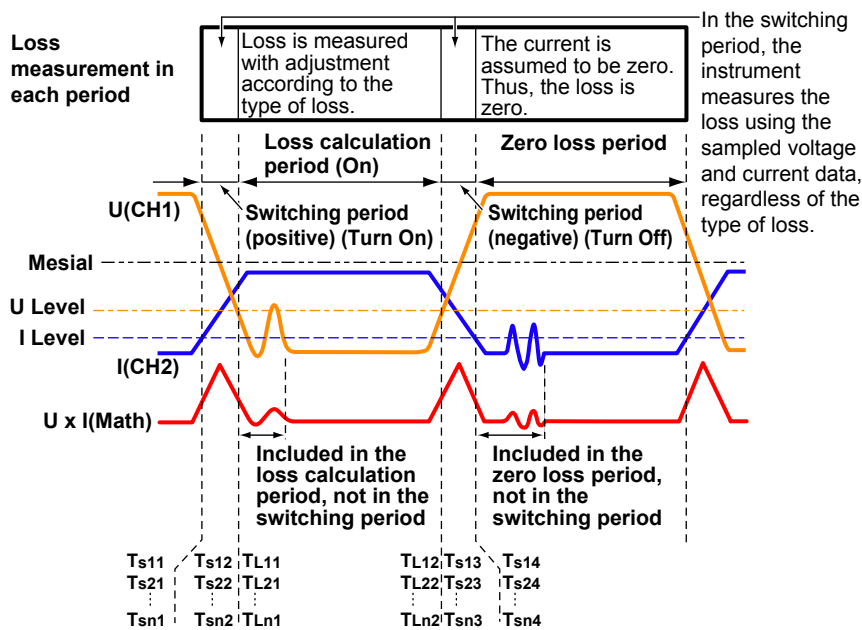

17 Power Supply Analysis Feature (Power Analysis and Power Measurement, Option)

- Loss calculation period: The period from the point where the voltage waveform goes below the U Level immediately after the waveform goes below the mesial level to the point where the waveform goes above the U Level immediately before the waveform goes above the mesial level.

If there are n voltage waveform cycles between the T Range1 and T Range2 cursors

When the type of loss is $RDS(on) \times I^2$,

Loss in the loss calculation period

$$= RDS(on) \left\{ \int_{TL11}^{TL12} i(t)^2 dt + \int_{TL21}^{TL22} i(t)^2 dt \cdots + \int_{TLn1}^{TLn2} i(t)^2 dt \right\}$$

RDS(on): On-resistance

Vce(SAT): Collector-emitter saturation voltage

i(t): Sampled current data

TL11, TL12, TL21, TL22...TLn1, TLn2: Time values in the loss calculation period

When the type of loss is $VCE(sat) \times I$,

Loss in the loss calculation period

$$= Vce(SAT) \left\{ \int_{TL11}^{TL12} i(t) dt + \int_{TL21}^{TL22} i(t) dt \cdots + \int_{TLn1}^{TLn2} i(t) dt \right\}$$

- Zero loss period: The period from the point where the current waveform first goes below the I Level after the waveform passes the middle point of the loss calculation period to the point where the waveform first goes above the I Level after the waveform passes the middle point between the relevant loss calculation period and the next loss calculation period. The instrument assumes that the current and loss are zero.
- Switching period: The period other than the loss calculation period or zero loss period described above. Positive switching period is the period in which the current waveform is rising; negative switching period is that in which the current waveform is falling.

If there are n voltage waveform cycles between the T Range1 and T Range2 cursors, there are 2n switching periods.

Loss in the switching period

$$= \int_{Ts11}^{Ts12} u(t) \cdot i(t) dt + \int_{Ts13}^{Ts14} u(t) \cdot i(t) dt + \int_{Ts21}^{Ts22} u(t) \cdot i(t) dt + \int_{Ts23}^{Ts24} u(t) \cdot i(t) dt \cdots + \int_{Tsn1}^{Tsn2} u(t) \cdot i(t) dt + \int_{Tsn3}^{Tsn4} u(t) \cdot i(t) dt$$

u(t): Sampled voltage data

i(t): Sampled current data

Ts11, Ts12, Ts13, Ts14, Ts21, Ts22, Ts23, Ts24...Tsn1, Tsn2, Tsn3, Tsn4:

Time values in the switching period

Level Setup (Level Setup)

Sets the voltage level (U Level) and current level (I Level) that are used to determine the loss period and cycle as well as the RDS(on) or Vce(SAT) values used to measure the loss over the loss calculation period.



Set the voltage level (U Level) and current level (I Level) within the amplitude range of the source waveforms.

Reference Levels (Ref Levels(CH1) and Ref Levels(CH3))

Sets the reference levels (distal, mesial, and proximal) used to determine the loss as percentages or as voltage values. This feature is the same as the reference level of the automated measurement of waveform parameters.

▶ [See here.](#)



- Set the mesial value to a value greater than U Level. If the mesial value is set to a value that is less than U Level, the measured values will be displayed as "*****."
 - If you set the reference levels using percentages, the distal, mesial, and proximal voltage values are determined depending on the waveform.
 - If you want to set reference levels that do not change based on the waveform, set the levels as voltage values.
 - Changing the reference level settings here will also change the reference level settings for the automated measurement of waveform parameters.
-

Measurement Items (Item Setup)

You can select which items to measure from the list below.

- Loss (Wp):
Turn On (loss over the switching period (positive)), On (loss over the loss calculation period), Turn Off (loss over the switching period (negative)), Total (loss over the switching period (positive and negative), sum of the losses in the loss calculation period)
The definition of loss is different depending on the type of loss as follows:
 - When the type of loss is U x I
Loss over multiple cycles (time Tc) within the period specified by the T Range1 and T Range2 cursors
▶ [See here.](#)
 - When the type of loss is RDS(on) x I² or VCE(sat) x I
Device's total loss over multiple cycles (time Tc) within the period specified by the T Range1 and T Range2 cursors ▶ [See here.](#)
- Loss per unit time (P): Turn On, On, Turn Off, Total
Turn On, On, Turn Off, and Total of the loss per unit time (P) correspond to those of the above loss (Wp).
The loss per unit time is determined by dividing the loss by time Tc. ▶ [See here.](#)
- Cycle Count (Cycle Count)
Cycle count in the period specified by the T Range1 and T Range2 cursors ▶ [See here.](#)



The maximum number of measurement items that can be displayed is 30 including the automatically measured waveform parameters. If the measured switching loss values are not displayed, reduce the number of automatically measured waveform parameters. ▶ [See here.](#)

17 Power Supply Analysis Feature (Power Analysis and Power Measurement, Option)

Unit (Unit)

Select the unit to use when displaying the measured values of Turn On, On, Turn Off, and Total of loss (Wp).

Wh: Watt-hours

J: Joules



The relationship between watt-hours and joules is as follows: $Wh=J/3600$

Turning the Measurement Location Indicator On and Off (Indicator)

Indicates with cursors the switching period (Turn On, Turn Off), the loss calculation period (On), and the measurement location on the time axis at the end of the cycle.

- ON: Cursors are displayed on the screen.
- OFF: Cursors are not displayed.

▶ [See here.](#)

Statistics (Statistics)

Statistics are displayed for the automated measurement values of waveform parameters. This item is the same as that of the automated measurement of waveform parameters.

▶ [See here.](#)

Source Window (Time Range)

Specify the range over which to measure the loss by selecting one of the following windows.

Main: Main window

Zoom1: Zoom1 window

Zoom2: Zoom2 window

Measurement Time Period (T Range1/T Range2)

The measurement time period is the range that can be extracted as a cycle within the range specified by T Range1 and T Range2.

Displaying Measured Results

When measurement results are displayed on the screen, symbols that indicate the measurement item and measurement channel are shown in front of the measured values as shown below.

Example

PTotal(C1)

PTotal: Sum of active power

C1: Voltage channel

Power Waveform Display (Power(Math1))

ON: The power waveform is displayed.

OFF: The power waveform is not displayed.



The instrument computes the power value by multiplying the actual measured values for voltage and current. The power waveform display is not affected by the specified U Level or I Level, even when cycle mode is on.

Scaling (Ranging)

Specify the vertical display range of the power waveform.

Auto (Auto Scaling)

The vertical display range is determined automatically based on the computed results.

Manual (Manual Scaling)

Set the display range by specifying the center power value (Center) on the vertical axis and the power per division (Sensitivity).

Safe Operating Area Analysis (SOA)

You can plot the voltage input channel on the X-axis (horizontal axis) and the current input channel on the Y-axis (vertical axis), evaluate the operating range characteristics of a power device (or other device), and check whether or not the device operations fall within the safe operating area (SOA) indicated in gray in the figure below.

Selecting SOA automatically sets the instrument to XY display mode.

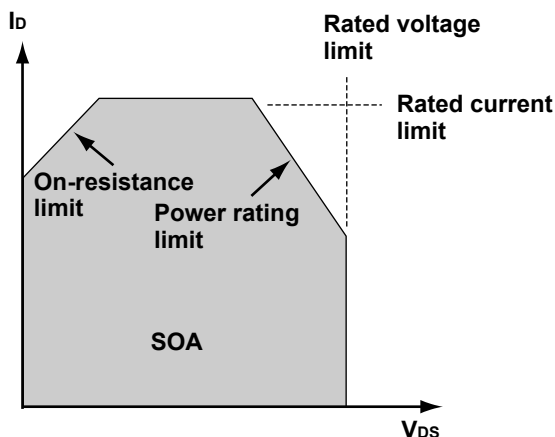

Probe Setup (ProbeSetup)

The channel selection, probe attenuation, voltage-to-current conversion ratio, and deskew settings are the same as those for the switching loss analysis feature.

▶ [See here.](#)

Turning the VT Waveform Display On or Off (VT Display)

The SOA is displayed in the XY window. Use this setting to choose whether or not to display VT waveforms with the XY waveforms.

OFF: The VT waveform display window does not appear.

ON: The VT waveform display window appears.

Cursor Measurement (Cursor)

You can display two cursors on both the X and Y axes and measure with them simultaneously.

The cursor setting range and measurement range are the same as those described in "Cursor Measurement (Cursor)" in chapter 8, "Displaying XY Waveforms."

▶ [See here.](#)

Display Area (T Range1 and T Range2)

Set the start point (T Range1) and the end point (T Range2) of the display and of the measurement time period.

Selectable range: ± 5 divisions with the center of the target window taken to be 0 divisions.

Harmonic Analysis (Harmonics)

You can measure and analyze harmonics.
 The harmonics display appears when you select Harmonics.

Harmonics

Harmonics are sine waves whose frequencies are integer multiples of the fundamental wave (normally a 50- or 60-Hz utility frequency sine wave). The input currents that flow through the power rectification circuits, phase control circuits, and other circuits used in various kinds of electrical equipment generate harmonic currents and voltages in power lines. When the fundamental wave and harmonic waves are combined, waveforms become distorted, and interference sometimes occurs in equipment connected to the power line.

The instrument can analyze the harmonics generated by the applicable devices specified in the IEC standards according to their device class (A to D).^{1, 2} To take measurements accurately in accordance with IEC standards, we recommend that you use a digital power meter from the WT3000 series and harmonic measurement software (761921), both produced by YOKOGAWA. However, the harmonic analysis features on the DLM series are a good way of measuring general characteristics.

- 1 IEC 61000-3-2 Edition 4.0
 EN 61000-3-2(2006)
 IEC 61000-4-7 Edition 2
- 2 “Applicable devices” refers to electrical and electronic devices that are connected to low voltage power distribution systems and that receive 16 A or less of current per cycle. The figure below provides a broad description of the applicable devices. However, while the instrument can perform harmonic analysis on single-phase devices, it cannot perform analysis on three-phase devices.

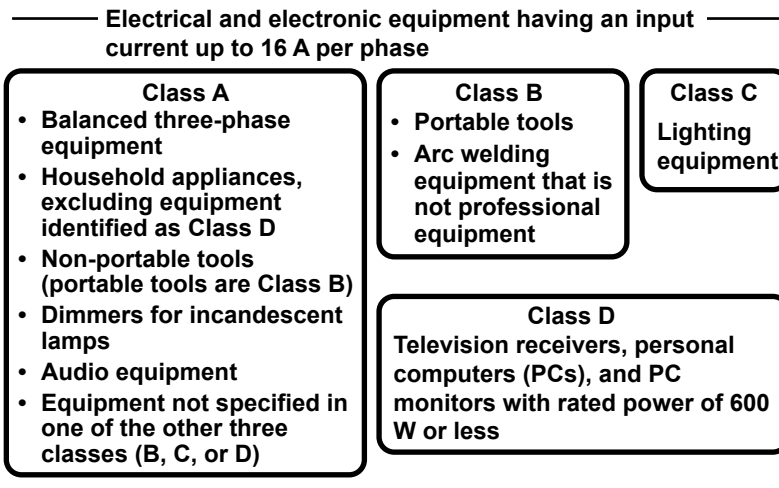

Fundamental Wave

The sine wave with the longest period among different sine waves derived from the periodic complex wave or the sine wave with the fundamental frequency among complex wave components.

Fundamental Frequency

In a periodic complex wave, this is the frequency corresponding to the longest period (the frequency of the fundamental wave).

Harmonic Order (harmonic order)

The ratio of the harmonic frequency to the fundamental frequency, expressed as an integer.
 The instrument can analyze harmonic components up to the 40th harmonic.

Harmonic Component (harmonic component)

The components of waveforms whose frequency is an integer multiple of two or more of the fundamental frequency.

Interharmonics (interharmonics)

If the input signal is 50 Hz in IEC harmonic measurement, a Fourier transform is taken on 10 periods of the input signal to derive frequency components in 5-Hz resolution. As a result, the area between two harmonics is divided into 10 frequency components. Interharmonics is the term used to refer to these intermediate frequency components.

If the input signal is 60 Hz, a Fourier transform is taken on 12 periods of the input signal to derive frequency components in 5-Hz resolution. As a result, the area between two harmonics is divided into 12 frequency components.

Measurement Conditions

To analyze harmonics, use the following measurement conditions.

trigger mode

To continuously analyze harmonics while acquiring waveforms, set the trigger mode to Normal.

▶ [See here.](#)

Time Window

Rectangle (rectangular window)

▶ [See here.](#)

Number of Waveforms and Number of Waveform Data Points

To perform analysis in accordance with harmonic current emission standards, you must configure the instrument so that the number of data points and the number of periods meet the following conditions.

- Number of data points
9000 points or more in 200 ms of data
- Period
50-Hz power supply (45 Hz to 55 Hz): 10 periods of data
60-Hz power supply (55 Hz to 65 Hz): 12 periods of data

Probe Setup (ProbeSetup)

The channel selection, probe attenuation, voltage-to-current conversion ratio, and deskew settings are the same as those for the switching loss analysis feature.

▶ [See here.](#)

Analysis Start Point (Start Point)

Set the analysis start point.

Power Supply Voltage of the EUT (System Voltage)

Set the power supply voltage of the device that you want to perform harmonic analysis on. The instrument uses the power supply voltage to determine the harmonic limits set by the harmonic current emission standard and uses the limits as references (see below for more information). The default setting is 230 V.

Selectable range: 90 V to 440 V

Resolution: 1 V

The harmonic current emission standard lists the limits for each harmonic when the (single-phase) power supply voltage is 220 V, 230 V, or 240 V. The limits for other power supply voltages must be determined through conversion. When the power supply voltage is outside of the range of 220 to 240 V, the instrument's power supply analysis feature uses the following equation to determine the limits for each class.

Converted limit = Limit for each class × 230/Equipment power supply voltage

Setting the Applicable Class (Class Setup)

Configure class-related settings.

Class (Class)

Sets the applicable class to A, B, C, or D.

17 Power Supply Analysis Feature (Power Analysis and Power Measurement, Option)

- **Necessary Class C Settings**

EUT's active power (Over 25 watts)

Select whether the EUT's active power exceeds 25 W (True) or not (False). For class C, the reference values change depending on the EUT's active power.

EUT's fundamental current (Fund Current)

Set the fundamental current when the EUT's load is at its maximum. To set the maximum current that is measured on the instrument, perform harmonic analysis with the maximum load, and then use the Max value that appears under the Order 1 column in the list.

For class C, evaluation is performed based on the ratio of harmonic components to the EUT's maximum fundamental current.

Power Factor (λ)

If the EUT's active (input) power exceeds 25 W (True), set the power factor that is observed when the EUT's load is at its maximum. You can acquire and use the currently measured power factor of the EUT (Get λ). For class C, if the EUT's active (input) power exceeds 25 W, the circuit power factor observed when the EUT's load is at its maximum is used to evaluate the ratio of the third harmonic component to the fundamental current.

The default setting is 0.80000.

Selectable range: 0.01 to 1.000

Resolution: 0.001

- **Necessary Class D Settings**

EUT's active power (Power)

Set the EUT's active power. For class D, the harmonic current per watt (power ratio limit) is also used in the evaluation.

Harmonic Grouping (Grouping)

There are three types of IEC harmonic groupings. The method for calculating the magnitude of the harmonic rms values is different for each grouping.

- **No grouping (OFF)**

Only components whose frequencies are integer multiples of the fundamental wave are considered harmonics. Interharmonic components are not included.

- **Grouping Type 1 (Type1)**

A harmonic subgroup is treated as a component of the subgroup's harmonic. A harmonic subgroup includes a given harmonic and its two adjacent interharmonics. Therefore, if the input signal includes a harmonic subgroup, harmonic values will be greater than they are when grouping is turned off.

- **Grouping Type 2 (Type2)**

A harmonic group is treated as a component of the group's harmonic. A harmonic group includes a given harmonic and all of its adjacent interharmonics. Therefore, if the input signal includes a harmonic group, harmonic values will be greater than they are when grouping is turned off.

Configuring the Display (Display Setup)

Turn the display of VT waveforms on or off and set the bar graph display method.

VT Display

OFF: Does not display the VT waveform display window

ON: Displays the VT waveform display window

Bar Graph Display (Scale)

You can display a bar graph of the computed values and the standard limits of each harmonic up to the 40th harmonic. You can set the scale to Linear or Log (logarithmic).

List Display (List)

You can display a list of the computed values and the standard limits of each harmonic up to the 40th harmonic. The contents of the list vary according to the class.

- When the class is A, B, or D
The list contains harmonic orders, their values and limits in amps, and information.
- When the class is C
The list contains harmonic orders, their values in amps, their limits (the standard limit ratio × the fundamental current value in amps), their values as percentages (computed harmonic value in amps ÷ fundamental current value in amps), their limits as percentages (ratio of the harmonic to the fundamental current), and information. The list also displays total harmonic distortion as percentages and rms values in amps. k denotes a harmonic order.

- **Total harmonic distortion (THD) [%]**
$$\frac{\sqrt{\sum_{k=2}^{40} I(k)^2}}{I(1)}$$

- **RMS value (RMS) [A]**
$$\sqrt{\sum_{k=1}^{40} I(k)^2}$$

List Size (List Size)

Select the list size and display position from one of the settings below.

Full Screen: Displays the list in full-screen mode

Half(Upper): Displays the list in the top half of the screen

Half(Lower): Displays the list in the bottom half of the screen

Saving the List (Save List)

You can save the data of the analysis results of each harmonic and standard limits in CSV format to a storage device. The extension is .csv.

Analysis Number (List No.)

The line corresponding to the number you select is highlighted.



- The instrument can perform harmonic analysis on single-phase devices but not on three-phase devices.
- IEC 61000-4-7 specifies that the measured data be smoothed using a first-order filter for 1.5 seconds, but the harmonics analysis results on the instrument are instantaneous values. Therefore, the results do not fully comply with the standard. To take make proper measurements in accordance with the standard, you need to use a YOKOGAWA WT3000 series digital power meter and its harmonic measurement software (761921).
- You can save the analysis results and the standard limits of each harmonic component to a CSV file. You cannot save the harmonic waveform data.
- You can save the original waveform data that you used for harmonic analysis. If you save the waveform data, you can load it onto an instrument with the power supply analysis feature (/G03 option) and perform harmonic analysis.
- You cannot perform harmonic analysis if 10 periods (for 45 Hz to 55 Hz) or 12 periods (for 55 Hz to 65 Hz) of a waveform correspond to less than 200 ms or if the number of data points is less than 9000 points. If this occurs, “-----” appears in the Measure (A) and Measure (%) columns in the list. “-----” also appears for harmonic limits (Limit(A)) that are not specified for a particular class.

Measuring Inrush Current by Computing the Joule Integral (I²t)

Measure the Joule integral (I²t) of the inrush current. This feature is useful when you are evaluating and comparing items such as device fuses.

When you select I²t, you can display measured values and a waveform of the Joule integral and compute statistics.

$$\text{Joule integral } I^2t \text{ [A}^2\text{s]} = \int_0^T i(t)^2 dt$$

T: Measurement time period
i(t): Sampled current data

Probe Setup (ProbeSetup)

The channel selection, probe attenuation, voltage-to-current conversion ratio, and deskew settings are the same as those for the switching loss analysis feature.

▶ [See here.](#)

Measurement Setup (Measure Setup)

Measurement Item (Item)

OFF: The Joule integral measured values are not displayed.

I²t: The Joule integral measured values are displayed.



You can display a total of up to 30 Joule integral measurement items and automatically measured waveform parameter items. If measured Joule integral values are not displayed, reduce the number of automatically measured waveform parameter items.

▶ [See here.](#)

Source Window (Time Range)

Specify the range over which to measure the Joule integral by selecting one of the following windows.

Main: Entire main window

Zoom1: Entire Zoom1 window

Zoom2: Entire Zoom2 window

Measurement Time Period (T Range1/T Range2)

Set the measurement time period in the source window.



The measurement range when power analysis I²t is specified is shared with the measurement range that is specified for the normal automated measurement of waveform parameters (Area1).

Displaying Measured Results

When measurement results are displayed on the screen, symbols that indicate the measurement item and measurement channel are shown in front of the measured values as shown below.

Example

I²t(C2)

I²t: Joule integral

C2: Current channel

Joule Integral (I^2t) Waveform Display ($I^2t(\text{Math1})$)

ON: The Joule integral (I^2t) waveform is displayed. Computation settings (MATH/REF) become invalid.

OFF: The Joule integral (I^2t) waveform is not displayed. Computation settings (MATH/REF) are valid.

Auto Scaling (Auto Ranging)

Executes auto scaling. Use this feature when the waveform amplitude changes greatly and the waveform is difficult to view.

You can also set the display range by specifying the vertical center I^2t value (Center) of the display area and the I^2t value per division (Sensitivity).



In Joule integral measurement, you can compute statistics in three different modes: Continuous, Cycle, and History.

Power Measurement (Power Measurement)

Power Measurement1, Power Measurement2

Power of up to two circuits can be measured simultaneously.

Turning Power Measurement ON or OFF (Mode)

Set whether to make power measurements.

- ON: Power measurement is enabled.
- OFF: Power measurement is disabled.



- [Power supply analysis](#) and power measurement of the power supply analysis feature cannot be executed simultaneously. If any of the power measurement items, Power Measurement1 to Power Measurement2, is set to ON, the power supply analysis is set to OFF. If power supply analysis is set to something other than OFF, all power measurements are set to OFF.
- For input channels that are assigned to power measurement and whose mode is set to ON, the following waveform parameters cannot be set: Max, Min, P-P, Rms, Mean, Sdev, Avg Freq. This is because these parameters overlap with those of the power measurement parameters, and the power measurement parameters are used in their place. [▶ See here.](#)
- If any of the power measurement modes is set to ON, cycle mode of automated measurement of waveform parameters is set to OFF.

Probe Settings (Probe Setup)

The pairs of voltage and current input channels are fixed. Refer to the table below and apply the appropriate voltage and current signals.

Power Measurement	Voltage Input Channel	Current Input Channel
Power Measurement1	CH1	CH2
Power Measurement2	CH3	CH4

Probe Attenuation Ratio and Voltage-to-Current Conversion Ratio (Probe CH1/CH2 or Probe CH3/CH4)

Select one of the probe attenuation ratios (CH1 or CH3) and one of the voltage-to-current conversion ratios (CH2 or CH4) listed below.

- CH1, CH3
0.001:1, 0.002:1, 0.005:1, 0.01:1, 0.02:1, 0.05:1, 0.1:1, 0.2:1, 0.5:1, 1:1, 2:1, 5:1, 10:1, 20:1, 50:1, 100:1, 200:1, 500:1, 1000:1, 2000:1
- CH2, CH4
0.001 A:1 V, 0.002 A:1 V, 0.005 A:1 V, 0.01 A:1 V, 0.02 A:1 V, 0.05 A:1 V, 0.1 A:1 V, 0.2 A:1 V, 0.5 A:1 V, 1 A:1 V, 2 A:1 V, 5 A:1 V, 10 A:1 V, 20 A:1 V, 50 A:1 V, 100 A:1 V, 200 A:1 V, 500 A:1 V, 1000 A:1 V, 2000 A:1 V



Changing the probe attenuation ratio or voltage-to-current conversion ratio here will change the same ratio in the CH key probe settings.

Deskewing Manually (Deskew CH1/CH2 or Deskew CH3/CH4)

You can set values for deskewing the transfer time difference between signals on each channel.

Auto Deskew Reference Waveform (Ref Trace)

Sets the reference waveform for auto deskewing. The instrument deskews the input signals by using the specified waveform as its reference.

Auto Deskewing (Auto Deskew)

Executes auto deskewing.



You can also manually deskew the input signals by using the jog shuttle.

Measurement Setup (Measure Setup)

Like automated measurement of waveform parameters, items related to power can be measured automatically. Set the measurement item for each input channel.

Input channels and Measurement Items (Item Setup)

- **Measurement Items of Voltage Input Channels CH1 and CH3**

Voltage: U+pk, U-pk, Up-p, Urms, Udc, Uac, Umn, Urmn

Average frequency: Avg Freq

Power: S, P, Q

Impedance: Z

Power factor: λ

Watt hours: Wp, Wp+, Wp-, Abs.Wp

For details on how each item is determined, see appendix 5, "How Power Measurement Items Are Determined."

▶ [See here.](#)

Unit (UNIT)

Select the unit to use when displaying the measured values for Wp, Wp+, Wp-, and Abs.Wp.

Wh: Watt-hours

J: Joules



The relationship between watt-hours and joules is as follows: $Wh=J/3600$

17 Power Supply Analysis Feature (Power Analysis and Power Measurement, Option)

- **Measurement Items of Current Input Channels CH2 and CH4**

Current: I+pk, I-pk, Ip-p, Irms, Idc, Iac, Imn, Irmn

Average frequency: Avg Freq

Ampere hours: q, q+, q-, Abs.q

For details on how each item is determined, see appendix 5.

▶ [See here.](#)



- The maximum number of measurement items that can be displayed is 30 including the automatically measured waveform parameters. If the measured power values are not displayed, reduce the number of automatically measured waveform parameters. ▶ [See here.](#)
 - For input channels that are assigned to power measurement and whose mode is set to ON, the following waveform parameters cannot be set: Max, Min, P-P, Rms, Mean, Sdev, Avg Freq. This is because these parameters overlap with those of the power measurement parameters, and the power measurement parameters are used in their place.
If you select any of the power measurement item U+pk, U-pk, Up-p, Urms, Udc, Uac, Avg Freq, I+pk, I-pk, Ip-p, Irms, Idc, Iac, and Avg Freq check boxes, the corresponding input channel waveform parameter Max, Min, P-P, Rms, Mean, Sdev, or Avg Freq check boxes will be selected.
-

Reference Levels (Ref Levels)

To determine the average frequency (Avg Freq), set the reference levels (distal, mesial, proximal) for each of the input channels as percentages or voltages. This feature is the same as the reference level of the automated measurement of waveform parameters.

▶ [See here.](#)



- If you set the reference levels using percentages, the distal, mesial, and proximal voltage values are determined depending on the waveform.
 - If you want to set reference levels that do not change based on the waveform, set the levels as voltage values.
 - Changing the reference level settings here will also change the reference level settings for the automated measurement of waveform parameters.
-

Measurement Location Indicator (Indicator)

Indicates the measured location of a specified item using cursors. You can select one item from the power measurement items whose check boxes are selected.

Cycle Mode (Cycle Mode)

OFF: Sets the measurement time range between T Range1 and T Range2.

N Cycle: Sets the time range to the left end of the first period that is between T Range1 and T Range2 to the right end of the Nth period

Calculation (Calc Setup)

You can define four calculations (Calc1 through Calc4) that use the measured power values. This feature is the same as the calculation of the automated measurement of waveform parameters. However, the measurement items that you can select from the Measure menu of the displayed expression dialog box are power measurement items.

▶ [See here.](#)

Statistics (Statistics)

Display the following five statistics on the automated measurement values of waveform parameters.

- Maximum (Max)
- Minimum (Min)
- Mean (Mean)
- Standard deviation (σ)
- The number of measured values used to calculate statistics (Count)

This item is the same as that of the automated measurement of waveform parameters.

▶ [See here.](#)

Source Window (Time Range)

Specify the range over which to measure the power by selecting one of the following windows.

Main: Main window

Zoom1: Zoom1 window

Zoom2: Zoom2 window

Measurement Time Period (T Range1/T Range2)

Set the measurement time period in the source window.

18 Displaying and Searching History Waveforms

Acquisition memory stores waveforms that are displayed on the screen and waveform data that have been acquired in the past. The history feature allows you to display or search past waveforms (history waveforms). You can perform the following operations on history waveforms:

- **Display**

You can display any single waveform or display all waveforms without gradation (and highlight only the specified waveform). You can also assign colors or intensities based on the frequency of occurrence of waveforms. You can list the timestamps (the trigger times) of all history waveforms.

Waveform Data for the Last N Triggers Is Stored

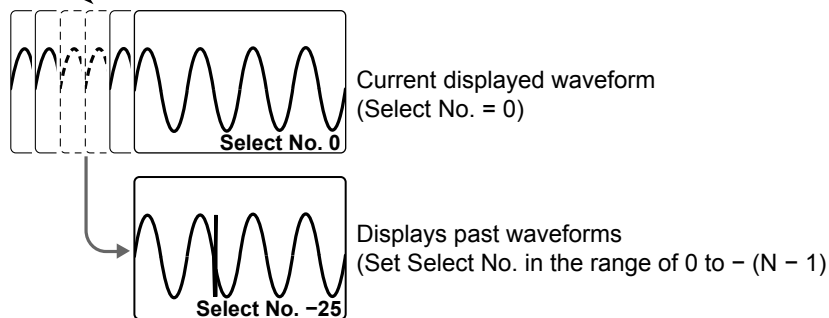

- **Search**

You can search for waveforms that meet the specified conditions, display the detected history waveforms, and list the timestamps of the waveforms.

Waveforms stored in the acquisition memory

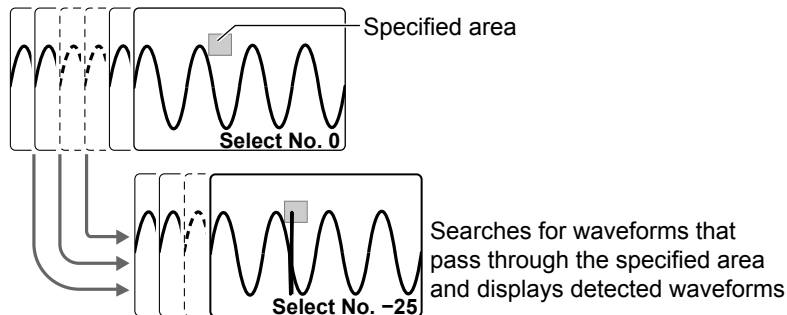

- **Average**

You can linearly average history waveforms in a specified range and display the averaged waveform.

- **Calculation, Cursor Measurement, Automated Measurement, Statistical Processing, and FFT**

You can perform calculations, cursor measurement, automated measurement of waveform parameters, or FFT analysis on the history waveform that you specified with Select No. You can also calculate statistics of automatically measured values on all history waveforms.

- **Displaying and Analyzing XY Waveforms**

You can display XY waveforms and perform analysis on the history waveform you specified with Select No. If the display mode is set to All, XY waveforms of all history waveforms are displayed.



- If you restart waveform acquisition by using the RUN/STOP key, all history waveforms that had been stored up to that point are cleared. However, if the trigger mode is set to Single (using the SINGLE key), the waveform that had been stored using the SINGLE key remains as a history waveform unless you change the waveform acquisition conditions.
- If you change the waveform acquisition conditions, all history waveforms that had been stored in the memory are cleared.
- If you change user-defined computation settings while using the history feature, recomputation is not performed on the history waveforms. To recompute, execute Math on History.

Display Mode (Mode)

Selects how history waveforms are displayed.

- One: Displays only the waveform of the selected record number
- All: Overlays all selected waveforms. All waveforms except the highlighted waveform are displayed in an intermediate color.
- Accumulate: Overlays all selected waveforms. The frequency of data occurrence is represented by intensity (Intensity) or by color (Color).

Average (Average)

Highlights the waveform obtained by taking a linear average of the history waveforms in the range specified by Start No. and End No. When the display mode is set All, all history waveforms that had been averaged are overlaid using an intermediate color.

Highlighting (Select No.)

The latest history waveform is assigned the record number zero, and older waveforms are assigned numbers in descending order (-1, -2, -3, and so on).

The waveform that correspond to the record number you specify here are highlighted.

Selectable range: 0 to -(the number of waveform acquisitions - 1)

You can use the jog shuttle to highlight history waveforms at high speeds. While you control the jog shuttle, history waveforms in the range corresponding to the speed of progression are collectively highlighted. Repeating this process, you can ultimately highlight all waveforms. When you stop controlling the jog shuttle, only the waveform of the record number indicated in Select No. will be highlighted.

Maximum Number of Waveform Acquisitions

(Maximum number of history waveforms that can be stored in the acquisition memory)

The number of history waveforms that can be stored varies depending on the selected record length and the installed memory options as follows:

Record Length	Number of History Waveforms		
	No options (125 Mpoints)	/M1 option (250 Mpoints)	/M2 option (500 Mpoints)
1.25 kpoints	20000	50000	100000
12.5 kpoints	2500	5000	10000
125 kpoints	250	500	1000
1.25 Mpoints	25	50	100
2.5 Mpoints	10	25	50
5 Mpoints	5	10	25
12.5 Mpoints	1	5	10
25 Mpoints	1 ¹	1	2
50 Mpoints	1 ¹	1 ¹	1
125 Mpoints	1 ^{1, 2}	1 ¹	1 ¹
250 Mpoints	-	1 ^{1, 2}	1 ¹
500 Mpoints	-	-	1 ^{1, 2}

1 Waveform acquisition operates in Single mode at this record length regardless of the trigger mode setting.

2 CH2 and CH4 (LOGIC) waveforms cannot be acquired at this record length. Math2 (Ref2) and Math4 (Ref4) are also unavailable.

Display Range (Start/End No.)

Using record numbers, set the range of history waveforms to display when the display mode is set to All or Accumulate.

Selectable range: 0 to -(the number of waveform acquisitions - 1)

List of Timestamps (List)

Lists the history waveforms' record numbers, trigger timestamps, and time differences from the previous data triggers.

The trigger timestamp resolution varies depending on the sample rate.

Searching the List

You can move to the following record number.

- Delta Max: Record number whose time difference between data triggers is highest
- Delta Min: Record number whose time difference between data triggers is lowest
- Oldest: The oldest record number
- Latest: The most recent record number

Searching History Waveforms (Search)

Search Condition (Condition)

Select the search logic. If you select AND, history waveforms that meet the logical product of search conditions 1 to 4 (described later) will be searched for. If you select OR, those that meet the logical sum of will be searched for.

- Simple: Searches for history waveforms that enter a rectangular zone
- AND: Searches for history waveforms that meet all search conditions
- OR: Searches for history waveforms that meet any of the search conditions

Search Conditions (1 to 4)

For search conditions 1 to 4*, set the source waveform, search range (the zone or the waveform parameter upper and lower limits), and the search criterion.

* 1 and 2 on the 2-channel model.



Search conditions 1 to 4 are shared with the reference conditions of GO/NO-GO determination.

Search Criterion (Condition)

Sets whether the source waveform must be in or out of the search range to be detected.

- IN: The source waveform is detected when it is in the search range.
- OUT: The source waveform is detected when it is out of the search range.

Source Waveform (Trace)

You can set the source waveform to one of the waveforms below.

CH1 to CH4/LOGIC,^{1,4} Math1 to Math4, XY1,² XY2,² FFT1,³ FFT2³

- 1 CH4 or LOGIC, whichever the corresponding key is illuminated, can be selected. If you select LOGIC, select the [source bit](#) (Bit0 to Bit7).
- 2 Waveform zones cannot be specified for XY waveforms.
- 3 Only waveform parameters can be specified for LOGIC and FFT.

Search Range Mode (Mode)

You can set the method of setting the search range to one of the settings below.

- RectZone: Rectangular zone.
- WaveZone: Waveform zone.
- PolygonZone: Polygonal zone.
- Parameter: Sets upper and lower limits for one measured waveform parameter

The methods for setting zones and the upper and lower limits of waveform parameters are the same as with GO/NO-GO determination (action).

▶ [See here.](#)

Executing a Search (Exec)

Searches for waveforms that meet the specified search conditions and displays only the waveforms and timestamps that are detected according to the display mode.

Finishing the Search (Reset)

Clears the history waveforms that were detected and displays all history waveforms.

Replay (Replay)

Displays the specified waveform first and then the older or newer data in order. The following replay features are available.

Oldest ◀	Display the oldest history waveform
◀	Replays waveforms toward older waveforms
■	Stop replay
▶	Replays waveforms toward newer waveforms
▶ Latest	Display the latest history waveform

Start Waveform (Select No.)

Specifies the record number to start replaying.
Selectable range: 0 to -(the number of waveform acquisitions - 1)

Replay Speed (Speed, Down/Up)

There are seven replay speed levels (Speed): x1/60, x1/30, x1/10, x1/3, x1, x3, and x10.

- Down: Decreases the replay speed by one level.
- Up: Increases the replay speed by one level.

Notes on Using the History Feature

Notes about Configuring the History Feature

- When the acquisition mode is set to Average and the sampling mode is set to Repetitive, you cannot use the history feature.
- When the display is in roll-mode, you cannot use the history feature.
- If you stop waveform acquisition, the instrument only displays waveforms that have been acquired completely.

Notes about Recalling Data Using the History Feature

- Waveform acquisition stops when you display the History menu. You cannot display history waveforms while waveform acquisition is in progress.
- You can start waveform acquisition when the History menu is displayed. However, you cannot change the history feature settings while waveform acquisition is in progress.
- The settings are restricted so that the following relationship is retained: Last record (End) ≤ Select No. ≤ First record (Start).
- When you load waveform data from the specified storage device, history waveforms up to that point are cleared. The loaded waveform data is placed in record number zero. If you load a file containing multiple waveforms, the latest waveform is placed in zero, and earlier waveforms are placed in order to record numbers 1, 2, and so on.
- Computation and automated measurement of waveform parameters are performed on the waveform of the record number specified by Select No. You can analyze old data as long as you do not overwrite the acquisition memory contents by restarting waveform acquisition. If Average is set to ON, analysis is performed on the averaged waveform.
- History waveforms are cleared when you turn the power off.

19 Printing and Saving Screen Captures

Destination Type (Print To)

You can save screen captures and print them on the following types of printers.

Built-in Printer (BuiltIn)

The optional built-in printer if it is installed.

▶ [See here.](#)

USB Printer (USB)

The printer that is connected to the instrument through one of the USB 2.0 ports.

▶ [See here.](#)

Network Printer (Network)

A printer on the network that the instrument is connected to. You must configure the network printer in advance.

▶ [See here.](#)

File (File)

You can save screen captures to files in PNG, BMP, and JPEG formats.

▶ [See here.](#)

Multiple Destinations (Multi)

You can perform the following operations at the same time.

- Print and save screen captures to multiple destinations
- Save waveform data to the output destination specified using the file list.

▶ [See here.](#)

Printing on the Built-in Printer (BuiltIn) (Option)

Print Mode (Mode)

On models with the optional built-in printer, you can print screen captures using one of two available modes. The screen capture is the same as that described in “[Saving Screen Captures to Files \(File\)](#).”

Hardcopy (Hardcopy)

The entire instrument screen is printed.

Normal (Normal)

The waveform area of the instrument screen is printed. The menu is not printed.

When the results of cursor measurements and automated measurement of waveform parameters are displayed, they are output below the waveform area.

Additional Information (Information)

You can print the instrument settings that were used at the time the waveform was acquired.

Printing on a USB Printer (USB)

You can print screen captures on a printer connected to one of the USB ports.

USB Ports

The instrument has a Type A USB port on the front panel as well as a Type A USB port and a Type B USB port on the rear panel. Connect the printer to one of the standard type A ports.

Front panel



Type A

Rear panel



Type A



Type B

Pin No.	Signal Name
1	VBUS: +5V
2	D-: -Data
3	D+: +Data
4	GND: Ground

Compatible Printers

You can use HP USB ink jet printers that comply with USB Printer Class Ver.1.0.



- Do not connect an incompatible USB printer.
- For USB printers that have been tested for compatibility, contact your nearest YOKOGAWA dealer.

Connection Procedure

Connect a USB printer to the instrument using a USB cable. You can connect or remove the USB cable regardless of whether the instrument's power switch is on or off (hot-plugging is supported). If you connect a printer when the power switch is on, the printer becomes available for use after the instrument identifies the printer.



-
- Do not connect multiple printers to the USB ports.
 - While the printer is printing, do not turn OFF the printer or remove the USB cable.
 - Do not connect or remove USB cables from the time when the instrument is turned on until key operation becomes available (approximately 20 to 30 seconds).
-

Print Mode (Mode)

You can print the screen image in one of two modes. The screen capture is the same as that described in "[Saving Screen Captures to Files \(File\)](#)."

Hardcopy (Hardcopy)

The entire instrument screen is printed.

Normal (Normal)

The waveform area of the instrument screen is printed. The menu is not printed.

When the results of cursor measurements and automated measurement of waveform parameters are displayed, they are output below the waveform area.

Printer Type (Format)

You can only use HP inkjet printers (HP InkJet).

Color (Color)

- ON: Prints using the same colors as the screen, excluding the background color. The grid is printed in black.
- OFF: Prints screen captures in the same way as when the instrument prints on the built-in printer.



-
- The comment may not be printed properly on some printers. Use a USB printer that has been tested for compatibility.
 - The instrument may not be able to detect out-of-paper or other errors on the USB printer. If an error occurs, press PRINT again to stop the printout.
-

Printing on a Network Printer (Network)

A printer on the network that the instrument is connected to. You must configure the network printer in advance.

▶ [See here.](#)

Print Mode (Mode)

You can print the screen image in one of two modes. The screen capture is the same as that described in “[Saving Screen Captures to Files \(File\)](#).”

Hardcopy (Hardcopy)

The entire instrument screen is printed.

Normal (Normal)

The waveform area of the instrument screen is printed. The menu is not printed. When the results of cursor measurements and automated measurement of waveform parameters are displayed, they are output below the waveform area.

Printer Type (Format)

The following printers can be used with the instrument.

- HP InkJet: HP inkjet printers
- HP Laser: HP laser printers

Color (Color)

- ON: Prints using the same colors as the screen, excluding the background color. The grid is printed in black.
- OFF: Prints screen captures in the same way as when the instrument prints on the built-in printer.

Saving Screen Captures to Files (File)

You can save screen captures to files in PNG, BMP, and JPEG formats.

Save Mode (Mode)

Hardcopy (Hardcopy)

The entire instrument screen is saved.

Example: When color data is ON (Gray)

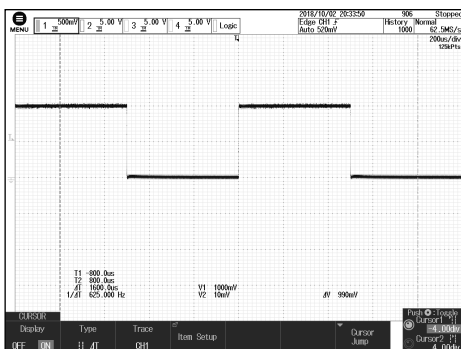

Normal (Normal)

The waveform area of the instrument screen is saved. The menu area is not saved.

When the results of cursor measurements and automated measurement of waveform parameters are displayed, they are output below the waveform area.

Example: When color data is ON (Gray)

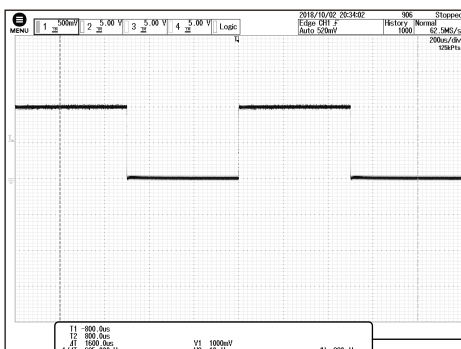

Measured Results

Wide (Wide)

The same screen capture as Normal mode but with the waveform time axis magnified 2 times. When the results of cursor measurements and automated measurement of waveform parameters are displayed, they are output below the waveform area.

Example: When color data is ON (Gray)

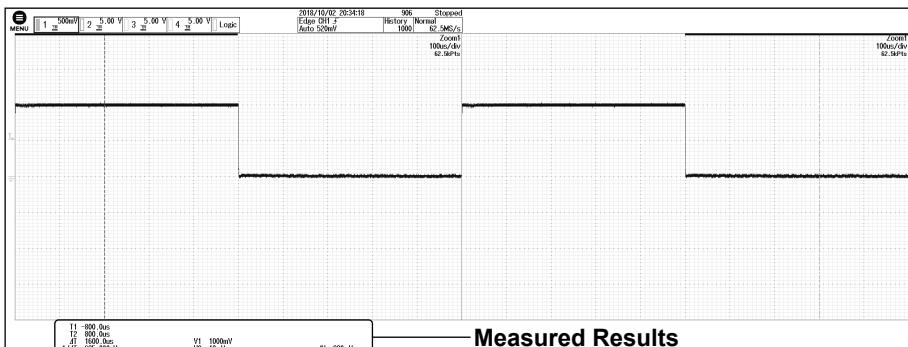

Measured Results

Data Format (Format)

- PNG: The extension is .png. The file size is approximately 50 KB when you save a black and white screen capture and approximately 200 KB when you save a color screen capture.
- BMP: The extension is .bmp. The file size is approximately 100 KB when you save a black and white screen capture and approximately 1.6 MB when you save a color screen capture.
- JPEG: The extension is .jpg. The file size is approximately 300 KB.



The file sizes listed here are for reference. Actual file sizes will vary depending on the image that is saved.

Color Data (Color)

- OFF: Saves data in black and white.
- ON: Saves data using 65536 colors.
- ON(Rev): Saves data using 65536 colors. The image background will be white.
- ON (Gray): Saves data using 32 grayscale levels.

Background Transparent or Opaque (Background)

For PNG format, you can save the waveform display area with a transparent background. This feature is convenient when you want to compare waveforms by overlaying screen captures on the PC.

- Normal: Saves data without changing the background (opaque).
- Transparent: Saves data by making the background transparent.

Including Setting Information (Information)

When save mode is set to Hardcopy or Normal, channels, triggers, waveform acquisition, and other setting information can be included in waveform screen captures.

- OFF: Setting information is not included.
- ON: Setting information is included.

Displaying the File List (File List)

Like the file feature, the instrument lists the files on the specified drive.

▶ [See here.](#)

Assigning File Names (File Name)

Like the file feature, you can save files with automatically generated names using sequence numbers or dates, or save the files with specific file names.

▶ [See here.](#)

Printing and Saving Screen Captures to Multiple Destinations (Multi)

You can print and save screen-capture and waveform data to multiple output destinations at the same time. The instrument outputs screen-capture and waveform data according to the PRINT menu or FILE menu settings.

- Save screen captures to files (File)
▶ [See here.](#)
- Print screen captures on the built-in printer (BuiltIn)
▶ [See here.](#)
- Print screen captures on a USB printer (USB)
▶ [See here.](#)
- Print screen captures on a network printer (Network)
▶ [See here.](#)
- Save waveform data (Waveform)
▶ [See here.](#)



-
- If you are saving both screen-capture and waveform data at the same time, they are saved to the last destination specified using the file list.
 - When you are executing action-on-trigger or GO/NO-GO determination, if Print To is set to Multi, you cannot print or save screen captures.
-

20 Saving and Loading Data

You can save the following types of data to the internal storage, a USB storage device, or a network drive.

- Waveform data
- Setup data
- Screen capture data
- Waveform zone data
- Snapshot waveform data
- Automated measurement data
- Serial bus analysis results
- FFT waveform data
- Histogram data
- List of Timestamps data

You can load the following types of data from a storage device into the instrument's internal storage.

- Waveform data
- Setup data
- Waveform zone and polygonal zone data
- Snapshot waveform data
- Physical value/symbol definition files

You can also rename and copy files and set or clear protection on files.

Storage Device You Can Save and Load From

This instrument can access the following three types of storage devices for saving and loading data.

Internal storage (Flash_Mem)

The internal storage of this instrument. For the memory size, see section 6.7 in the *Getting Started Guide* (IM DLM3054-03EN).

USB Storage Device (USB/USB1)

A USB storage device that is connected to the instrument's USB port. USB2.0 mass storage devices compatible with USB Mass Storage Class Ver. 1.1 can be connected to the instrument.

Network Drive (Network)

A storage device on the network. If a Ethernet port is available, you can connect the instrument to an Ethernet network and use a network drive.

▶ [See here.](#)



-
- Only connect a compatible USB keyboard, mouse, printer, or storage device to the USB port for peripherals.
 - Do not connect and disconnect multiple USB devices repetitively. Provide at least a 10-second interval between removal and connection.
 - Do not connect or remove USB cables from the time when the instrument is turned on until key operation becomes available (approximately 20 to 30 seconds).
 - You can use USB storage devices that are compatible with USB Mass Storage Class version 1.1.
 - The instrument can handle up to two storage devices. If the connected medium is partitioned, the instrument treats each partition as a separate storage device. As such, the instrument can handle up to two partitions.
-

Saving Data (Save)

The instrument saves data to the specified storage device.

[Waveform data](#), [Setup data](#), [Other types of data](#)

Saving Waveform Data (Waveform)

You can save the waveform data that the instrument has measured to a file in binary or ASCII format or to a file in ASCII format with time information.

Save Destination (File List)

Specify the data save destination.

File name (File Name)

Set the file name. You can also use the auto naming feature to automatically assign file names.

Auto Naming (Auto Naming)

- OFF
The auto naming feature is disabled. The name that you specify using the File Name setting is used.
- Numbering
The instrument automatically adds a three-digit number from 000 to 999 after the common name specified using the File Name setting and saves files.
- Date
An 8-character file name produced based on the date and time using base 36 numbers (0 to 9 and A to Z). See the figure below. The file name specified using the File Name setting is not used.

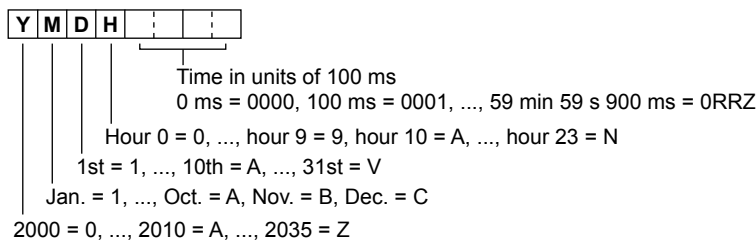

- Date2
The file name is the date and time (down to ms) when the file is saved. The file name specified using the File Name setting is not used.

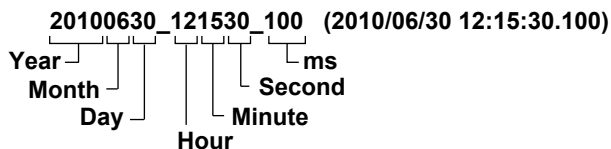

File name (File Name)

You can set the common file name that is used when the auto naming feature is turned off or when the auto naming feature is set to Numbering.

The maximum number of characters that you can use for file names and folder names is 64 characters. The following restrictions apply.

- The following types of characters can be used: 0 to 9, A to Z, a to z, _, -, =, (,), {, }, [,], #, \$, %, &, ~, !, `, and @. @ cannot be entered consecutively.
- The following exact strings cannot be used due to MS-DOS limitations:
AUX, CON, PRN, NUL, CLOCK, LPT1, LPT2, LPT3, LPT4, LPT5, LPT6, LPT7, LPT8, LPT9, COM1, COM2, COM3, COM4, COM5, COM6, COM7, COM8, COM9

- Make sure that the full file path (absolute path from the root folder) is less than or equal to 255 characters in length. If this is exceeded, an error will occur when you perform file operations (save, copy, rename, create folder, etc.).

When an operation is being performed on a folder, the full path is up to the name of the folder. When an operation is being performed on a file, the full path is up to the name of the file.

If you set auto naming to Date (date and time), the characters that you entered for the file name will not be used. File names will only consist of the date information.

Comment (Comment)

You can add a comment that consists of up to 128 characters when you save a file. You do not have to enter a comment.

All characters, including spaces, can be used in comments.

Data Type (Data Type)

Set the data type to binary, ASCII, or ASCII with time information.

Binary (Binary)

The data stored to the acquisition memory is saved to a file in binary format.

You can load the data into the instrument, display the waveform of the data, and view the values that it contains.

You can use the YOKOGAWA's Xviewer software application to analyze waveforms on your PC. For more details, contact your nearest YOKOGAWA dealer. You can download a trial version from the YOKOGAWA website.

- Data size \approx Record length (Mpoint) \times 2 (bytes/point) \times the number of traces (from 1 to 8)
- The extension is .wdf.

ASCII

The sampled data stored in the acquisition memory is converted using the specified range and saved to a file in ASCII format.

You can use the file to analyze waveforms on your PC. You cannot load this type of data into the instrument.

- If the record length is less than or equal to 1.25 Mpoints, all of the waveform data can be saved.
If the record length is more than 1.25 Mpoints, the data is compressed and saved.
- Data size \approx Record length (Mpoint) \times 10 (bytes/point) \times the number of traces (from 1 to 8)
- The extension is .csv.

ASCII with Time Information (ASCII with TimeInfo.)

The time information is attached to the data stored in the acquisition memory, and this data is converted using the specified range and saved to a file in ASCII format.

- Data size \approx Record length (Mpoint) \times {10 (bytes/point) \times the number of traces (from 1 to 8)+ 16 (bytes/point)}
- The extension is .csv.

Waveform to Save (Trace)

You can save all of the displayed waveforms (All) or select a specific waveform to save. The waveforms that you can save are CH1 to CH4/LOGIC,* and Math1 to Math4. The vertical-axis, horizontal-axis, and trigger settings are also saved along with the waveforms.

If you select all waveforms, only the waveforms that are displayed out of CH1 to CH4/LOGIC, and Math1 to Math4 are saved.* CH4 or LOGIC, whichever the corresponding key is illuminated, can be selected.

History Range (History)

Of the waveforms that are selected to be saved, set which range of history waveforms to save.

- One: The single waveform that is specified with Select No. on the HISTORY menu* will be saved.
 - All: All history waveforms within the range bounded by Start No. and End No. on the HISTORY menu* will be saved. If you search for history waveforms, and then select All, only the detected waveforms will be saved.
- * The menu that appears when HISTORY is pressed

History Range One and All Settings

The history range is fixed to One or All depending on the display mode (Mode) and the type of data to be saved (Data Type) on the HISTORY menu.

Display Mode (Mode) on the HISTORY Menu	One	All	Accumulate
Binary	One or All selectable	One or All selectable	Fixed to All
Type of data to be saved (Data Type)			
ASCII	Fixed to One	Fixed to One	Fixed to One
ASCII with TimeInfo.	Fixed to One	Fixed to One	Fixed to One



If Average on the HISTORY menu is set to ON, only a single set of averaged waveform data will be saved regardless of the display mode specified on the HISTORY menu, the type of data to be saved, and the history range.

▶ [See here.](#)

Window to Be Saved (Range)

Select the window to be saved from the following:

- Main: Main window
- Zoom1: Zoom1 window
- Zoom2: Zoom2 window

Data Compression (Compression)

If the window to be saved is set to Main, you can save the waveform data by compressing or sampling it. If you want to save waveform data whose record length exceeds 1.25 Mpoints to a file in ASCII format, the data must be compressed.

OFF

All the data in the specified range is saved without compression or sampling. Binary files can be loaded into the instrument. Data in ASCII format or Data with time information in ASCII format cannot be loaded.

Saving Data through Compression (p-p)

The waveform data is P-P compressed so that the number of data points is equal to the specified number and then saved. Data that has been compressed and saved cannot be loaded into the instrument regardless of the format (data in ASCII format, data with time information in ASCII format, or data in binary format).

Saving Data through Sampling (Decim)

The data is sampled (decimated) so that the number of data points is equal to the specified number and then saved. Data that has been sampled and saved cannot be loaded into the instrument regardless of the format (data in ASCII format, data with time information in ASCII format, or data in binary format).



-
- The accumulate setting is always off while waveform data is loaded.
 - Compressed and sampled waveform data in binary format can be loaded into the instrument as a reference waveform. For details, see the explanation under "Loading Data."
 - If you change the extension of the saved data file, by using a PC or some other device, the instrument will no longer be able to load it.
 - Up to 2500 files and folders can be displayed in the file list. If there are more than a total of 2500 files and folders in a given folder, the file list for that folder will display only 2500 files and folders. There is no way to set which files and folders are displayed.
 - If the window to be saved is set to Zoom1 or Zoom2, data compression is not possible. Therefore, waveform data whose number of data points on the window to be saved exceeds 1.25 Mpoints cannot be saved to a file in ASCII format.
-

Saving Setup Data (Setup)

You can save setup data to a file or to three different internal memory locations.

Saving Setup Data to a File

Like waveform data, you can save setup data to a specified storage device.

You can specify file names and enter comments in the same way as with waveform data.

▶ [See here.](#)

Saving Setup Data to Internal Memory

You can save up to three sets of setup data to internal memory areas #1 to #3. It is convenient to save setup data that you use frequently.

- **#1 to #3**

Setup data numbers. To save or load setup data, you can simply specify one of these numbers.

- **Detail Settings (Detail)**

You can add comments to setup data for identification and protect setup data from overwriting. The detail setting screen also displays the date and time when the setup data is saved.

Saving Other Types of Data (Others)

You can save screen image data, waveform zone data, snapshot waveform data, automated measurement values of waveform parameters, serial bus analysis results, FFT computation results (FFT waveform data), histogram data, and list of timestamps.

For details on the serial bus analysis results, see “[Serial Bus Analysis Results \(Others - Serial Bus \(FlexRay/CAN/CAN FD/LIN/CXPI\)\)](#)” and “[Serial Bus Analysis Results \(Others - Serial Bus \(SENT/UART/I²C/SPI\)\)](#),” later in this manual.

You can specify file names in the same way as with waveform data.

▶ [See here.](#)

Screen Captures (Screen Image)

You can save the displayed screen image to a file in PNG, BMP, or JPEG.

Data Format (Format)

- PNG: The extension is .png. The file size is approximately 50 KB when you save a black and white screen capture and approximately 200 KB when you save a color screen capture.
- BMP: The extension is .bmp. The file size is approximately 100 KB when you save a black and white screen capture and approximately 1.6 MB when you save a color screen capture.
- JPEG: The extension is .jpg. The file size is approximately 300 KB.



- The file sizes listed here are for reference. Actual file sizes will vary depending on the image that is saved.
- You can also save screen captures using the menu that you can access by pressing SHIFT+PRINT. The screen captures that you can save using the FILE menu explained here are the same as those that you can save by selecting Normal in the SHIFT+PRINT menu. If you want to save screen captures including the setup menu or if you want to save images whose time axis is magnified two times, use different options in the menu that you can access by pressing SHIFT+PRINT.

▶ [See here.](#)

Color (Color)

- OFF: Saves data in black and white.
- ON: Saves data using 65536 colors.
- On (Reverse): Saves data using 65536 colors. The image background will be white.
- Gray: Saves data using 32 grayscale levels.

Background (Background)

For PNG format, you can save the waveform display area with a transparent background. This feature is convenient when you want to compare waveforms by overlaying screen captures on the PC.

- Normal: Saves data without changing the background (opaque).
- Transparent: Saves data by making the background transparent.

Including Setting Information (Information)

Setting information such as channels, triggers, and waveform acquisition can be included in waveform screen captures.

- OFF: Setting information is not included.
- ON: Setting information is included.

Waveform Zone (Wave-Zone)

You can save waveform zones (Zone No.1 to 4) that are used in GO/NO-GO determination and history waveform searching.

▶ [See here.](#)

Zone1 to Zone4 can be saved to separate files.

The waveform zone file name extension is .zwf. The data can be loaded into the instrument.

Snapshot Waveform Data (Snap)

You can save the waveform data captured in a snapshot.

The extension is .snp. The data can be loaded into the instrument.

Automated Measurement Values of Waveform Parameters (Measure)

Save the results of automatic waveform parameter measurement to a file in CSV format. The extension is .csv. CSV files are text files that contain data separated by commas. They are used to convert data between spreadsheet and database applications.

The maximum number of previous values that you can save is equal to 100000 ÷ number of items that are turned on.

Data size in bytes = Number of measured items × 15 × number of history waveforms

Output Example

Analysis Type	WaveParameter					
Model Name	DLM3000					
Model Version	*.**					
	Rms(C1)	Mean(C1)	Sdev(C1)	ITY(C1)	Dly(C1)	Calc1(A2)
	V	V	V	Vs	s	
:Max	7.12E-01	5.05E-03	7.12E-01	5.05E-05	1.13E-03	1.13E+00
:Min	7.10E-01	-4.44E-03	7.10E-01	-4.44E-05	-8.99E-04	1.08E+00
:Mean	7.11E-01	1.07E-03	7.11E-01	1.07E-05	3.44E-04	1.10E+00
:Sigma	2.47E-04	2.04E-03	2.48E-04	2.04E-05	9.68E-04	8.23E-03
:Cnt	134	134	134	134	134	134
7021	7.11E-01	2.29E-03	7.11E-01	2.29E-05	1.11E-03	1.10E+00
7031	7.11E-01	1.43E-03	7.11E-01	1.43E-05	1.11E-03	1.11E+00
7040	7.11E-01	3.51E-03	7.11E-01	3.51E-05	1.11E-03	1.10E+00
7050	7.11E-01	1.73E-03	7.11E-01	1.73E-05	1.11E-03	1.11E+00
7059	7.11E-01	1.80E-03	7.11E-01	1.80E-05	-8.86E-04	1.11E+00
7069	7.11E-01	1.15E-03	7.11E-01	1.15E-05	1.11E-03	1.10E+00
7078	7.11E-01	1.45E-04	7.11E-01	1.45E-06	-8.82E-04	1.12E+00
7088	7.11E-01	2.98E-03	7.11E-01	2.98E-05	1.11E-03	1.10E+00
7098	7.11E-01	3.27E-03	7.11E-01	3.27E-05	-8.92E-04	1.09E+00
7107	7.11E-01	3.12E-03	7.11E-01	3.12E-05	-8.83E-04	1.12E+00

FFT Computation Results (FFT)

You can save the results of computation that was specified using FFT1 or FFT2 in CSV format. The extension is .csv. Up to 250 Kpoints of data can be saved.

Freq Info.

- OFF: The results are saved without frequency information.
Data size in bytes = The number of data points × 15
- ON: All data is saved with frequency information.
Data size in bytes = The number of data points × 30

▶ [See here.](#)

Output Example

(When Freq Info. is set to OFF)		(When Freq Info. is set to ON)	
Analysis Type	FFT	Analysis Type	FFT
Model Name	DLM3000	Model Name	DLM3000
Model Version	*.**	Model Version	*.**
Data Points	6251	Data Points	6251
HResolution	5.00E+00	HResolution	1.00E+02
HUnit	Hz	HUnit	Hz
	-3.10E+01		0.00E+00
	-5.43E+01		1.00E+02
	-4.16E+01		2.00E+02
	-6.69E+01		3.00E+02
	-4.80E+01		4.00E+02
	-5.26E+01		5.00E+02
	-6.39E+01		6.00E+02
	-5.11E+01		7.00E+02
	-5.17E+01		8.00E+02
	-5.87E+01		9.00E+02
			-5.48E+01
			-7.27E+01
			-5.84E+01
			-7.79E+01
			-6.12E+01
			-6.14E+01
			-6.02E+01
			-6.58E+01
			-6.18E+01
			-6.53E+01

Histogram (Histogram)

You can save the histogram of the waveform or the waveform parameter that was specified using Hist1 or Hist2.

▶ [See here.](#)

List of Timestamps (History List)

You can save the list of history waveform information—record number, trigger time, and the difference between the trigger times of the history waveform and its previous history waveform—in CSV format. The extension is .csv.

Data size in bytes = The number of history waveforms × 72

▶ [See here.](#)

Output Example

Data Type	HistoryList		
Model Name	DLM3000		
Model Version	* **		
Start No.	0		
End No.	-99		
No.	Trig'd Time	Delta	
	0 16:12:08.407 320	0.006 000	
	-1 16:12:08.401 320	0.008 000	
	-2 16:12:08.393 320	0.006 000	
	-3 16:12:08.387 320	0.006 000	
	-4 16:12:08.381 318	0.015 002	
	-5 16:12:08.366 318	0.006 000	
	-6 16:12:08.360 318	0.006 000	
	-7 16:12:08.354 318	0.006 000	
	-8 16:12:08.348 318	0.006 000	
	-9 16:12:08.342 318	0.036 000	
	-10 16:12:08.306 320	0.005 998	

Serial Bus Analysis Results (Others - Serial Bus (FlexRay/CAN/CAN FD/LIN/CXPI))

You can save analysis results for the buses that you specified with the Serial Bus1, Serial Bus2, Serial Bus3 and Serial Bus4 settings.

For details on SENT, UART, I²C, and SPI analysis results, see “Serial Bus Analysis Results (Others - Serial Bus (SENT/UART/I²C/SPI)).”

History Range (History)

The analysis results are saved according to the settings made on the HISTORY menu and the analysis result save menu. For details on the feature, see “Setting the History Range” for when saving waveform data. You can select the history range for saving analysis results from the same options that are available as when you save waveform data in binary format.

▶ [See here.](#)

You cannot save the results of analyzing a user-defined serial bus signal (User Define).

FlexRay

You can save analysis results of FlexRay bus signals to a file in CSV format. The extension is .csv. Analysis results of up to 5000 frames can be saved.

Data size* = (The number of frames in analysis results + 4) × 60 bytes

* The data size is for reference. It is not strictly warranted. Use this as reference for saving data.

Output Example

No.	Time(ms)	S/D	IND	ID	Len	CC	Data	Information
-7	-0.358624	S	1111	4	4	5	01 02 03 04 05 06 07 08	
-6	-0.307424	S	0000	5	4	5	00 00 00 00 00 00 00 00	
-5	-0.256224	D	1111	6	5	5	C8 C9 CA CB CC CD CE CF D0 D1	
-4	-0.205008	D	1111	7	2	5	FF FF FF FF	
-3	-0.153808	D	1111	8	6	5	01 01 01 01 01 02 02 02 02 03 03 03 03	
-2	-0.102608	S	0011	1	4	6	01 01 01 01 01 01 01 01	
-1	-0.051408	S	0011	2	4	6	02 02 02 02 02 02 02 02	
0	-0.000208	S	0010	3	4	6	03 03 03 03 03 03 03 03	
1	0.050992	S	1111	4	4	6	01 02 03 04 05 06 07 08	
2	0.102192	S	0000	5	4	6	00 00 00 00 00 00 00 00	
3	0.153392	D	1111	6	5	6	C8 C9 CA CB CC CD CE CF D0 D1	
4	0.204584	D	1111	7	2	6	FF FF FF FF	
5	0.255784	D	1111	8	6	6	01 01 01 01 01 02 02 02 02 03 03 03 03	
6	0.307184		0000					FES Error
7	0.358184	S	0011	2	4	7	02 02 02 02 02 02 02 02	

<p>Analysis number</p> <p>Amount of time from the trigger position to the start of frame</p> <p>Frame type</p> <p>Indicator information in binary</p> <p>ID in decimal</p> <p>Payload length in decimal</p> <p>Cycle count</p> <p>Data1 in hexadecimal</p>	<p>Error information</p> <p>BSS Error</p> <p>CRC Error</p> <p>HCRC Error</p> <p>FES Error</p>
--	---

CAN, CAN FD

You can save analysis results of CAN or CAN FD bus signals to a file in CSV format. The extension is .csv. Analysis results of up to 100000 frames (50000 frames for CAN FD) can be saved.

Data size*

CAN: (The number of frames in analysis results + 4) × 125 bytes

CAN FD: (The number of frames in analysis results + 4) × 300 bytes

* The data size is for reference. It is not strictly warranted. Use this as reference for saving data.

CAN Output Example

Analysis Type	SerialBus(CAN)	Model Name	Model Version	DLC in hexadecimal		Data in hexadecimal		CRC sequence in hexadecimal	
				Frame ID	DLC	Data	CRC	Ack	Information
-8	-17.5848	Data	00A	2	1			0	
-7	-17.2968	Error							
-6	-15.0728	Data	00A	2	01 02	4A24	Y		
-5	-12.5608	Data	12	1	FE	2263	Y		
-4	-10.1204	Data	100	3	FF 01 A4	6C6E	Y		
-3	-7.5364	Data	00A	2	01 02	4A24	Y		
-2	-5.0244	Data	12	1	FE	2263	Y		
-1	-2.5844	Data	100	3	FF 01 A4	6C6E	Y		
0	-0.0004	Data	00A	2	01 02	4A24	Y		
1	2.5116	Data	12	1	FE	2263	Y		
2	4.9516	Data	100	3	FF 01 A4	6C6E	Y		
3	7.5356	Data	00A	2	01 02	4A24	Y		

ID in hexadecimal
 Frame type
 Amount of time from the trigger position to the start of frame
 Analysis number
 ACK slot state
 Y: ACK present
 N: ACK not present

CAN FD Output Example

“CAN FD:ISO” is displayed when the CAN FD standard is set to ISO.
 “CAN FD:non-ISO” is displayed when the CAN FD standard is set to non-ISO.

Analysis Type	SerialBus(CAN FD:ISO)	Model Name	Model Version	DLC in hexadecimal		Data in hexadecimal		When the CAN FD standard is set to ISO, the stuff count is displayed in hexadecimal notation.	
				Frame ID	DLC	Data	SC		
-5	-2.137288	FD Data	1FFFFFFF	4	FF FF FF FF	C	11606	Y	CRC Error(Seq)
-4	-2.034984	Error							
-3	-1.943288	FD Data	15555555	8	55 AA C3 0F 55 AA C3 0F	0	19B09F	Y	
-2	-1.71728	FD Data	0AAAAAAAA	8	AA 55 3C F0 AA 55 3C F0	0	005ED1	Y	
-1	-1.00528	FD Data	78	2	0F 0F	A	00C18	Y	
0	-0.19673	FD Data	01E38000	1	7	9	1592F	Y	ESI(Error Passive)
1	1.050728	FD Data	101	0		3	1417A	Y	
2	1.200728	FD Data	102	0		C	0EADE	Y	
3	1.650736	FD Data	104	1	8	6	312	N	
4	2.006736	Data	0	8	00 00 00 00 00 00 00 00		145B	Y	

ID in hexadecimal
 Frame type
 (“Data” is displayed for CAN.)
 Amount of time from the trigger position to the start of frame
 Analysis number
 ACK slot state
 Y: ACK present
 N: ACK not present
 Error information
 Stuff Error
 Fixed Stuff Error
 CRC Error(SC;Seq)
 ESI(Error Passive)
 etc.

20 Saving and Loading Data

LIN

You can save analysis results of LIN bus signals to a file in CSV format. The extension is .csv. Analysis results of up to 100000 frames can be saved.

Data size* = (The number of frames in analysis results + 4) × 125 bytes

* The data size is for reference. It is not strictly warranted. Use this as reference for saving data.

Output Example

Analysis Type		SerialBus(LIN)				Checksum in hexadecimal	
Model Name		DLM3000					
Model Version		* **					
No.	Time(ms)	ID	ID-Field	Data	Checksum	Information	
-4	-208.116	3E	11	19 2A 3B 4C 5D 6E 7F 81	68		
-3	-156.036	3E	11	19 2A 3B 4C 5D 6E 7F 81	68		
-2	-103.952	3E	11	19 2A 3B 4C 5D 6E 7F 81	68		
-1	-51.868	3E	11	19 2A 3B 4C 5D 6E 7F 81	68		
0	0.216	3E	11	19 2A 3B 4C 5D 6E 7F 81	68		
1	52.3	3E	11	19 2A 3B 4C 5D 6E 7F 81	68		
2	104.384	3E	11	19 2A 3B 4C 5D 6E 7F 81	68		
3	156.464	3E	11	19 2A 3B 4C 5D 6E 7F 81	68		
4	208.548	3E	11	19 2A 3B 4C 5D 6E 7F 81	68		

Data in hexadecimal
ID-Field in hexadecimal
ID in hexadecimal
Amount of time from the trigger position to the start of frame
Analysis number

Error information
ID Parity Error
Checksum Error

CXPI

You can save analysis results of CXPI bus signals to a file in CSV format. The extension is .csv. Analysis results of up to 10,000 frames can be saved.

Data size* = (The number of frames in analysis + 4) × 900 bytes

* The data size is for reference. It is not strictly warranted. Use this as reference for saving data.

Output Example

Analysis Type		SerialBus(CXPI)					Data in hexadecimal		CRC in hexadecimal	
Model Name		DLM3000								
Model Version		* **								
No.	Time(ms)	ID	DLC	W/S	CT	Data	CRC	Information		
-3	-52.4732	3	L16	0	0	00 11 22 33 44 55 66 77 88 99 AA BB CC DD EE FF	2B30			
-2	-32.4704	4	12	0	0	40 41 42 43 44 45 46 47 48 49 4A 4B	D0			
-1	-12.4676	5	12	0	0	50 51 52 53 54 55 56 57 58 59 5A 5B	E0			
0	-0.4864	P20	2	0	0	01 FF	A1			
1	7.5356	6	12	0	1	60 61 62 63 64 65 66 67 68 69 6A 6B	7D			
2	27.5384	7	12	0	1	70 71 72 73 74 75 76 77 78 79 7A 7B	4D			
3	47.5412	8						ID-Parity Error		
4	67.544	9	12	0	0	90 91 92 93 94 95 96 97 98 99 9A 9B	F4	CRC Error		
5	87.5468	0A	12	0	1	A0 A1 A2 A3 A4 A5 A6 A7 A8 A9 AA AB	96	Data Length Error		
6	107.5496	0B	12	0	1	B0 B1 B2 B3 B4 B5 B6 B7 B8 B9 BA BB		Framing Error		
7	127.5524	0C						IBS Error		

CT in decimal
W/S indicator in binary
DLC in decimal
ID in hexadecimal
Amount of time from the trigger position to the start of frame
Analysis number

Error information
PTYPE Parity Error
ID Parity Error
CRC Error
Data Length Error
Framing Error
IBS Error
Clock Error
Counter Error

Serial Bus Analysis Results (Others - Serial Bus (SENT/UART/I²C/SPI))

You can save analysis results for the buses that you specified with the Serial Bus1, Serial Bus2, Serial Bus3 and Serial Bus4 settings.

For details on FlexRay, CAN, CAN FD, LIN, and CXPI analysis results, see “[Serial Bus Analysis Results \(Others - Serial Bus \(FlexRay/CAN/CAN FD/LIN/CXPI\)\)](#).”

History Range (History)

The analysis results are saved according to the settings made on the HISTORY menu and the analysis result save menu. For details on the feature, see “Setting the History Range” for when saving waveform data. You can select the history range for saving analysis results from the same options that are available as when you save waveform data in binary format.

▶ [See here](#).

You cannot save the results of analyzing a user-defined serial bus signal (User Define).

SENT

You can save analysis results of SENT signals to a file in CSV format. The extension is .csv. Analysis results of up to 100000 frames can be saved.

Data size*

Fast CH or Both list: (The number of frames in analysis results + 4) × 100 bytes

Slow CH list: (The number of frames in analysis results + 4) × 30 bytes

* The data size is for reference. It is not strictly warranted. Use this as reference for saving data.

Output example of a Fast CH or Both List

Analysis Type	SerialBus(SENT)	Binary display of status and communication											
		Hexadecimal or decimal display of data (according to data type (Nibble, User))											
Model Name	DLM3000	No.	Time(ms)	Sync(us)	Tick(us)	S&C	D1	D2	D3	D4	D5	D6	CRC
Model Version	**												
Length(tick)	Information	SlowCH											
-1	-1.115384	167.92	3.00	0000	8	B	6	E	B	7	7		
	299.97												
0	-0.215884	167.91	3.00	0100	8	B	6	E	C	7	9		
	306.99												
1	0.704592	167.94	3.00	0000	8	B	6	E	D	7	B		
	305.96												
2	1.622156	167.91	3.00	0000	8	B	6	E	E	7	D		
	225.00												

20 Saving and Loading Data

Output example of a Slow CH List

Analysis Type		SerialBus(SENT)		Hexadecimal or decimal display of CRC	
Model Name		DLM3000		Error information	
Model Version		**			
No.	Time(ms)	ID	Data	CRC	Information
-3	-45.94672	6	3	0D	
-2	-30.6392	1	205	0B	
-1	-15.31336	2	900	28	
0	-0.01192	88	201	20	
1	15.48904	1	206	1A	
2	31.01336	2	930	30	

Hexadecimal or decimal display of data
 Hexadecimal or decimal display of ID
 Amount of time from the trigger position to the start of frame
 Analysis number

UART

You can save analysis results of UART signals to a file in CSV format. The extension is .csv. Analysis results of up to 300000 bytes can be saved.

Data size* = (The number of frames in analysis results + 4) × 40 bytes

* The data size is for reference. It is not strictly warranted. Use this as reference for saving data.

Output Example (when grouping is set to ON)

Analysis Type		SerialBus(UART)			
Model Name		DLM3000			
Model Version		**			
No.	Time(ms)	Data(HEX)	Data(ASCII)	Information	
-4	-209.948	00 80 40 C0 20 04 84 44@. ..D\$.L,..B."		
-3	-157.864	00 80 40 C0 20 04 84 44@. ..D\$.L,..B."		
-2	-105.78	00 80 40 C0 20 04 84 44@. ..D\$.L,..B."		
-1	-53.696	00 80 40 C0 20 04 84 44@. ..D\$.L,..B."		
0	-1.612	00 80 40 C0 20 04 84 44@. ..D\$.L,..B."		
1	50.468	00 80 40 C0 20 04 84 44@. ..D\$.L,..B."		
2	102.552	00 80 40 C0 20 04 84 44@. ..D\$.L,..B."		
3	154.636	00 80 40 C0 20 04 84 44@. ..D\$.L,..B."		
4	206.72	00 80 40 C0 20 04 84 44@. ..D\$.L,..B."		

Data1 in hexadecimal Data1 in ASCII
 Amount of time from the start point
 Analysis number
 Error information
 Framing Error
 Parity Error

I²C

You can save analysis results of I²C bus signals to a file in CSV format. The extension is .csv. Analysis results of up to 300000 bytes can be saved.

Data size* = (The number of bytes in the analysis results / 2 + 4) × 125 bytes

* The data size is for reference. It is not strictly warranted. Use this as reference for saving data.

Output Example

		SerialBus(I2C)				Analysis result in hexadecimal	
		1st	2nd	R/W	Data	Information	
Analysis Type		DLM3000					
Model Name		DLM3000					
Model Version		.**					
No.	Time(ms)	1st	2nd	R/W	Data	Information	
-4	-208.116	AA*		W	AE* 8B*		
-3	-156.036	75*		R	BC* EF		
-2	-103.952	38*		W	53* A9*		
-1	-51.868	9D*		R	10* 4B		

Read/Write bit state
(W stands for write; R stands for data request.)

Address type
Amount of time from the trigger position

Analysis number

* ACK present

SPI

You can save analysis results of SPI bus signals to a file in CSV format. The extension is .csv. Analysis results of up to 300000 bytes can be saved.

Data size* = (The number of bytes in the analysis results × 2 + 4) × 125 bytes

* The data size is for reference. It is not strictly warranted. Use this as reference for saving data.

Output Example

		Type	SerialBus(SPI)
Analysis		DLM3000	
Model Name		DLM3000	
Model Version		.**	
No.	Time(ms)	Data	
-6	-0.65304	Data1 00 00 00 00 00 7F FF FF FF FF FF F8 00	
-5	-0.63704	Data1 FF E0 00 3F FF FF FF FF FF FC 00 07 FF	
.....			
-4	-0.60504	Data1 FF E0 00 00 00 7F FF 00 00 00 03 FF FF FF	
-3	-0.25304	Data1 00 1F FF C0 00 7F FF 00 01 FF FF FF FF FF	
-2	-0.23704	Data1 FF FF FF C0 00 00 00 00 00 00 03 FF F8 00	
-1	-0.20504	Data1 00 1F FF FF FF 80 00 FF FE 00 03 FF F8 00	
0	0.14696	Data1 00 00 00 3F FF FF FF FE 00 03 FF FF FF	
1	0.16296	Data1 00 1F FF FF FF FF FF FF FF FC 00 07 FF	
.....			
2	0.19496	Data1 FF FF FF C0 00 00 00 00 01 FF FC 00 00 00	
.....			
3	0.54696	Data1 00 1F FF FF FF 80 00 FF FF FF FF FF F8 00	

Data1 in hexadecimal
Amount of time from the start point

Analysis number

Loading Data (Load)

You can load waveform data, setup data, waveform zones, polygonal zones, and snapshot waveforms that have been saved by the instrument.

You can also view information about the saved data files using the File Property menu item.

Loading Waveform Data (Waveform)

You can load waveform data, including Math1 to Math4 waveforms. Waveform data in binary format (files with .wdf extension) can be loaded.

File Properties (File Property)

You can display the file name (Name), data size (Size), save date (Date), attributes (Attr) and other file properties regarding the selected file.

Loading Waveform Data into Channels (Load to Channels)

You can load the waveform data of the specified file along with the setup data into the acquisition memory. All the data in the file is loaded.

This command is used to view or analyze waveform data that has been stored in the past on the instrument.

- You can display computed waveforms by setting the computation mode on the MATH/REF key menu to Math1 to Math4.
- Because setup data is also loaded, the instrument settings change when you load waveform data.
- Loaded data is cleared when you start measurement.

Loading Waveform Data into Reference Waveforms (Load to Ref1(Math1), Load to Ref2(Math2), Load to Ref3(Math3), Load to Ref4(Math4))

You can load the waveform data of the specified file as a reference waveform. Setup data is not loaded.

Reference waveforms are used to compare current waveforms to waveforms saved in the past and to perform computation.

- You can display reference waveforms by setting the computation mode on the MATH/REF key menu to Ref1 to Ref4.
- If the number of data points exceeds the specified record length, the instrument samples the data so that the number of points is equal to the specified record length and displays the sampled data.



-
- You may not be able to load waveform data if the memory size of the model that you used to save the waveform data with and that of the model that you are trying to load data into are different. If the waveform data record length is less than or equal to 1.25 Mpoints, the instrument loads the data.
 - To load a file saved from the waveform data of multiple channels as a reference waveform, use Load to Channels to load the waveform into channels, and then load the waveform as a computation [reference waveform](#).
 - The waveforms that have been acquired at the maximum record length and the waveform data that has been acquired at the maximum record length and saved to files cannot be loaded as a reference waveform.
-

Loading Setup Data (Setup)

You can load setup data. There are two methods you can use to load setup data. One method is to load setup data that has been saved to a file. The other method is to load setup data that is saved in the internal memory.

Viewing the Contents of Setup Data (File Property)

You can view information about the setup data that has been saved to the internal storage or to a USB storage device.

Loading Setup Data That Has Been Saved to a File (Load Setup File)

You can load a .set file that contains setup data that you have saved.

Loading Setup Data That Has Been Save to an Internal Memory Location (#1 to #3)

You can load setup data that has been saved to internal memory locations #1 to #3.

Detailed Information (Detail)

You can view the date and time when setup data was saved to internal memory areas #1 to #3 and the comments attached to the data.

You can change comments, or enable or disable file protection.

Loading Other Types of Data (Others)

You can load waveform zones, polygonal zones, snapshot waveforms, and serial bus signal symbols.

Waveform and Polygonal Zones (Wave-Zone/Polygon-Zone)

You can load waveform zones that you created on the instrument into internal storage locations Zone1 to Zone4. You can load zones that have been saved to .zwf files using this instrument and polygonal zones that have been saved to .msk files using the dedicated software application.

These zones are used for GO/NO-GO determination and other purposes.

Snapshot Waveforms (Snap)

You can load .snp files that contain snapshot waveforms that you have saved.

The snapshot waveforms that you load are displayed in white on the screen.

Symbol Data (Symbol)

Character strings based on definitions in a CANdb file can be used to express bit patterns. You can load physical value/symbol definition files (.sbl extension) that you have edited using the Symbol Editor tool.

The bit patterns can be used as CAN bus signal trigger conditions or as analysis or search conditions.

- **Files with .sbl Extensions**

CANdb files (.dbc extension) must be converted into physical value/symbol definition files (.sbl extension) using the free YOKOGAWA conversion software "Symbol Editor" before they can be loaded and used as trigger conditions or as analysis or search conditions on the instrument.

You can obtain the free software from the YOKOGAWA website (<http://www.yokogawa.com/yimi/>).

CANdb files (.dbc) are signal definition database files created using the CANdb or CANdb++ software produced by Vector Informatik.

File Operations (Utility)

You can create folders on the storage device, delete and copy files, change file names, and so on.

File List (File List)

Display Format

Selects whether to display a list of files or to display thumbnails.

Sorting the List

You can sort the file list by file name, data size, date, etc.

File path

The instrument displays various storage device as follows:

- Flash_Mem: Internal storage
- USB: The first detected USB storage device that is connected to the instrument's USB port (type A) for connecting peripheral devices.
- USB1: The USB storage device that is connected to the instrument's USB port (type A) for connecting peripheral devices (the second connected device).
- Network: Network storage device

Selecting Multiple Files or Folders (Select)

Selects or unselects all of the files or folders in the list.

You can also only select or unselect the highlighted files or folders.

Making Folders (Directories) (New Folder)

You can make folders.

▶ [See here.](#)

Copying and Moving Files and Folders (Copy, Move)

You can copy or move selected files and folders to other storage media or folders.

Renaming Files and Folders (Rename)

You can rename a selected file or folder.

Protecting Files (Protect)

You can change the attribute of the selected file. This is the same feature as turning the protection on and off.

Deleting Files and Folders (Delete)

You can delete the selected files and folders.

File Properties (File Property)

You can display the file name (Name), data size (Size), save date (Date), attributes (Attr) and other file properties regarding the selected file.

Turning Protection On or Off (Protect ON/OFF)

You can turn protection on or off for the selected file. The change is reflected in the file attributes, displayed under the Attr column in the file list.

Protection	File Attribute	Description
ON	r	File protection is on for the selected file. The file can be read from. Writing is not allowed. Deleting is also not allowed.
OFF	r/w	File protection is off for the selected file. The file has read and write access.

Selecting Files (All Set, All Reset, and Set/Reset)

Selects or unselects all of the files or folders in the list.

You can also only select or unselect the highlighted files or folders.



- You can format the internal storage (Flash_Mem) by pressing UTIL and then using Storage Manager on the System Configuration menu.
▶ [See here.](#)
- You can abort file copying and deleting. However, files that are already being processed are not applicable.

21 Ethernet Communication (Network)

You can configure TCP/IP parameters and use the Ethernet interface to perform the following tasks.



To use this feature, set the communication interface to Network (from the UTILITY menu, select Remote Control > Device > Network).

TCP/IP

TCP/IP settings for connecting to an Ethernet network.

Set the IP address, subnet mask, and default gateway.

▶ [See here.](#)

FTP Server (FTP Server)

You can connect the instrument as an FTP server to a network.

You can connect to the instrument from a PC on the same network and retrieve waveform data.

▶ [See here.](#)

Mail (Mail)

The action-on-trigger or GO/NO-GO action can be set to mail transmission.

▶ [See here.](#)

Network Drive (Net Drive)

You can save waveform data and setup data to a network drive.

▶ [See here.](#)

Network Printer (Net Print)

You can specify a network printer for printing screen captures.

▶ [See here.](#)

SNTP

The instrument clock can be set using SNTP. The instrument can be configured to automatically adjust its clock when it is turned on.

▶ [See here.](#)



To connect a PC to the instrument, use a hub or router, and connect to a network. Do not connect a PC directly to the instrument.

TCP/IP(TCP/IP)

Configure the settings that the instrument needs to connect to a network.

DHCP

DHCP is a protocol that temporarily allocates settings that a PC needs to connect to the Internet.

To connect to a network that has a DHCP server, turn the DHCP setting on. When DHCP is turned on, the IP address can be automatically obtained when the instrument is connected to a network. (You do not have to set it manually.)

When DHCP is turned off, you must set the appropriate IP address, subnet mask, and default gateway for the network.

DNS

DNS is a system used to associate Internet host names and domain names with IP addresses. Given AAA.BBBBB.com, AAA is the host name and BBBBB.com is the domain name.

You can use host names and domain names to access the network instead of using IP addresses, which are just numbers. The instrument allows you to specify the host by name, instead of by IP address.

Set the domain name and the DNS server address (0.0.0.0 by default). For details, consult your network administrator.

DNS Servers (DNS Server1/DNS Server2)

You can specify up to two DNS server addresses: primary and secondary. If querying fails with the primary DNS server, the secondary DNS server is automatically used to find the mapping of the host name and domain name to the IP address.

Domain Suffixes (Domain Suffix1/Domain Suffix2)

The domain suffix is a piece of information that is automatically added when a query is made to a DNS server using only a portion of the domain name. For example, if BBBBB.co.jp is registered as a domain suffix and a query is made using "AAA," the name "AAA.BBBBB.co.jp" is searched.

You can specify up to two domain suffixes: Domain Suffix1 and Domain Suffix 2.

You can use up to 30 characters. The characters that you can use are 0 to 9, A-Z, a-z, and dashes.

TCP/IP settings are applied when you press Set or when you turn on the instrument the next time.

FTP Server (FTP Server)

You can connect the instrument as an FTP server to a network.

Set the user name and password that will be used by devices on the network to access the instrument. Also, set the access timeout value.

FTP Server On and Off (FTP Server)

ON: The FTP server feature is enabled.

OFF: The FTP server feature is disabled.

User Name (User Name)

Set the user name that will be used to access the instrument from a PC. The characters that you can use are all the ASCII characters on the keyboard. You can use up to 30 characters. If you set the user name to "anonymous," you can connect to the instrument without entering a password.

Password (Password)

Set the password that will be used to access the instrument from a PC. The characters that you can use are all the ASCII characters on the keyboard. You can use up to 15 characters.

Timeout (Timeout)

If a connection cannot be established between the instrument and the PC within the amount of time specified here, the instrument aborts the connection process.

Selectable range: 0 s to 3600 s



To apply the settings that you specified, press Set.

FTP Server Overview

When the instrument is connected to the network as an FTP server, the following features become available.

FTP Server Feature

From a PC, you can view a list of files that are stored in the instrument storage device (the internal memory or a storage device that is connected to it) and retrieve files.

Compatible PCs

A PC running the English or Japanese version of Windows 7 (32 bit or 64 bit), Windows 8.1 (32 bit or 64 bit), or Windows 10 (32 bit or 64 bit)

Mail (Mail)

You can send trigger times and other information in emails to a specific email address as an action in the action-on-trigger or GO/NO-GO determination feature.

Mail Server (Mail Server)

Specify the IP address of the mail server on the network that the instrument will use. In a network with a DNS server, you can specify the host name and domain name instead of the IP address.

Mail Address (Mail Address)

You can specify multiple email recipient addresses. Separate each address with a comma.

Comment (Comment)

If necessary, you can enter a comment in the first line of e-mails.

Attaching Image Files (Attached Image File)

You can attach a capture of the screen that is displayed at the time the email is sent.

File format: PNG

File name: DLM_image[time].png

(Example: DLM Image081202171158.png is a screen capture taken at 17:11:58 on December 2, 2008.)

Resolution: XGA (1024×768 dots)

Approximate File Size

Normal screen: Approx. 50 KB

Maximum: Approx. 1.6 MB (when the screen contains many colors)

Timeout (Timeout)

If the instrument cannot send an email for the amount of time specified here, it disconnects from the mail server. Selectable range: 1 s to 60 s

User Authentication (POP3 before SMTP)

Before you send an e-mail, POP3 user authentication is performed.

- **User Authentication On and Off**

ON: Authentication is performed before e-mails are sent.

OFF: Authentication is not performed before e-mails are sent.

- **Encryption type**

U/P: The authentication data is sent in plain text.

APOP: The authentication data is encrypted before it is sent.

- **Server name**

Set the POP3 server host name or IP address using up to 30 characters. The characters that you can use are all the ASCII characters on the keyboard.

- **User name**

Set the user name that is required for accessing the POP3 server from the instrument using up to 30 characters. The characters that you can use are all the ASCII characters on the keyboard.

- **Password**

Set the password that is required for accessing the POP3 server from the instrument using up to 30 characters. The characters that you can use are all the ASCII characters on the keyboard.



The instrument supports plaintext (U/P) and encrypted (APOP) POP3 user authentication.*

* APOP uses the MD5 algorithm (Message-Digest Algorithm 5 by RSA Data Security, Inc.).

Sending a Test Mail (Send Test Mail)

You can send a test mail to check whether emails can be sent properly.

Network Drive (Net Drive)

You can save waveform data and setup data to a network drive.

FTP Server (FTP Server)

Specify the IP address of the FTP server (network drive) for saving waveform and setup data. In a network with a DNS server, you can specify the host name and domain name instead of the IP address.

User Name (User Name)

Set the user name (login name) for logging in to the network drive. The characters that you can use are all the ASCII characters on the keyboard. You can use up to 14 characters.

Password (Password)

Specify the password that corresponds to the login name. The characters that you can use are all the ASCII characters on the keyboard. You can use up to 14 characters.

Passive Mode (Passive)

Turn FTP passive mode on or off.

In passive mode, the FTP client sets the port number for data transfer. Enable passive mode when you have set an external FTP server as a network drive or when you are accessing an FTP server through a firewall.

Timeout (Timeout)

If the instrument cannot transfer files for a certain amount of time, it disconnects from the FTP server.

Selectable range: 0 s to 60 s

Connecting to the Network Drive (Connect/Disconnect)

When you press the Connect button, the instrument connects to the specified network drive, and the drive appears in the file list (File List). When you press the disconnect button, the network drive is disconnected and removed from the file list (File List).

Network Printer (Net Print)

You can print screen captures on a network printer.

The instrument can print to the following printers.

- HP inkjet printers (HP InkJet)
- HP Laser printers (HP Laser)

LPR Servers (LPR Server)

Specify the IP address of the printer server that the instrument will connect to. In a network with a DNS server, you can specify the host name and domain name instead of the IP address.



LPR is a protocol used to print over a TCP/IP network.

LPR Name (LPR Name)

The name of the shared printer that the instrument will connect to.

Timeout (Timeout)

If the instrument cannot print for a certain amount of time, it disconnects from the network printer.

Selectable range: 0 s to 60 s

SNTP (SNTP)

The instrument clock can be set using Simple Network Time Protocol (SNTP). The instrument can be configured to automatically adjust its clock when it is turned on.

SNTP Server (SNTP Server)

Specify the IP address of the SNTP server that the instrument will use. In a network with a DNS server, you can specify the host name and domain name instead of the IP address.

Timeout (Timeout)

If the instrument cannot connect to the SNTP server for a certain amount of time, it aborts the operation.

Selectable range: 1 s to 60 s

Executing Time Adjustment (Set)

The instrument clock is synchronized to the SNTP server clock.

Automatic Adjustment (Adjust at Power On)

You can configure the instrument so that its clock is automatically synchronized to the SNTP server clock when the instrument is turned on when it is connected to the network.



-
- If the time difference from GMT (Greenwich Mean Time) is set in the date/time setting, the instrument will make appropriate adjustments to the time information received from the SNTP server.
▶ [See here.](#)
 - If you do not want the instrument to synchronize with an SNTP server, do not set the SNTP server IP address.
-

22 Other Features

Auto Setup (AUTO SETUP)

The auto setup feature automatically sets the SCALE, TIME/DIV, trigger level, and other settings to the most suitable values for the input signals.

This feature is useful when you are not sure what type of signal will be applied to the instrument. The auto setup feature will not work properly on some input signals.

Center Position after the Execution of Auto Setup

The center position after you execute auto setup will be 0 V.

Source Channels

Auto setup is performed on all channels except the logic channels.

Waveforms Displayed before the Execution of Auto Setup

Waveforms that were displayed before you execute auto setup will be cleared.

Signals That Auto Setup Can Be Applied To

You can use auto setup for the following types of input signals.

- Simple, repeating signals whose frequency is 50 Hz or higher
- Absolute input voltage: Signals whose maximum value is at least approx. 20 mV (at 1:1 setting)



-
- The auto setup feature may not work properly for signals that include a DC component or high-frequency components.
 - The auto setup menu for analyzing serial bus signals is located in the setup menu of each serial bus analysis.
▶ [See here.](#)
-

Undoing Auto Setup (Undo)

You can revert to the settings that were used immediately before you executed auto setup.

Default Settings (DEFAULT SETUP)

You can reset the instrument settings to their factory default values. This feature is useful when you want to cancel all the settings that you have entered or when you want to redo measurement from scratch. Default setup refers to the act of resetting the instrument settings to their factory default values.

Items That Cannot Be Reset

The following settings cannot be reset.

- Date and time settings
- Communication settings
- Language setting (English or Japanese)
- Measured value font size setting
- Touch panel feature on/off

Undoing Default Setup (Undo)

If you perform default setup by mistake, you can undo it by pressing the Undo soft key. However, you cannot undo the reset operation if you clear the Undo menu item by switching to a different setup menu or pressing the ESC key.

To Reset All Settings to Their Default Values

While holding down the RESET key, turn the power switch on. All settings except the date and time settings (display on/off setting will be reset) and the setup data stored in internal memory will be reset to their factory default values.

Snapshot (SNAP SHOT)

Retains the currently displayed waveforms on the screen. This feature allows you to update the display without having to stop waveform acquisition. It is a useful feature when you want to compare waveforms.

Snapshot waveforms are displayed in white and moves behind the normal waveforms.

You cannot perform the following operations on snapshot waveforms.

Cursor measurement, automated measurement of waveform parameters, zoom, or computation

You can save load snapshot waveforms.

Clear Trace (CLEAR TRACE)

Clears all the waveforms that are displayed on the screen.

If you change the display format or perform other similar operations, the instrument redisplay the channel waveforms, computed waveforms, and loaded waveforms that were displayed before you executed the clear trace operation.

If you execute a clear trace operation during waveform acquisition, the instrument restarts waveform acquisition (from the first acquisition). All history waveforms that have been stored up to that point are cleared. Snapshot and clear trace features are disabled:

Snapshot and clear trace features are disabled:

- When the instrument is printing, when it is executing auto setup, or when it is accessing a storage device.
- When GO/NO-GO determination is in progress, when action-on-trigger is in progress, or when searching is in progress.

Calibration (Calibration)

Executing Calibration (Cal Exec)

You can calibrate the vertical axis ground level and gain. Execute calibration when you want to make accurate measurements.

Calibration is automatically performed for the settings listed above when the power switch is ON.

Notes about Calibration

- Allow the instrument to warm up for at least 30 minutes before you execute calibration. If you execute calibration immediately after power-on, the calibrated values may drift due to temperature changes or other environmental changes.
- Execute calibration in a stable temperature environment ranging from 5°C to 40°C (23 ± 5°C recommended).
- Do not apply signals when calibrating. Calibration may not be executed properly when input signals are being applied to the instrument.

Auto Calibration (Auto Cal)

Auto calibration is executed when you perform one of the following operations and any of the time periods listed below has elapsed since the power was turned on.

90 seconds, 3 minutes, 10 minutes, 30 minutes, 1 hour, and each following hour

- Change the time scale (time/div) during waveform acquisition (when the RUN/STOP key is illuminated)
- Start waveform acquisition after stopping waveform acquisition (so that the RUN/STOP key is not illuminated)



If calibration is executed while signals are being applied to the instrument, we recommend that you stop signal application and recalibrate the instrument.

Remote Control (Remote Control)

Communication interface for controlling this Instrument from a PC. For details, see the communication interface user's manual, IM DLM3054-17EN.

Types of Communication Interfaces (Device)

USB, GP-IB, and Network are the available communication interfaces.



-
- Only use the selected communication interface. If you send commands simultaneously from another communication interface that has not been selected, the instrument will not execute the commands properly.
 - The instrument is in Remote mode while it is communicating with a PC. When in Remote mode, "REMOTE" appears in the center of the top section of the screen. All keys except SHIFT + CLR are disabled in Remote mode.
-

USB

Connects the instrument to a PC using USB.

USB Communication (USB Function)

You can specify the communication features that are used when you connect the instrument to a PC through USB.

- **USBTMC**

You can use USB TMC (Test and Measurement Class) to control the instrument from a PC.

To connect the instrument to a PC through the USB port, carry out the following procedure.

- Install YOKOGAWA USB driver in your PC.
- Do not use USB drivers (or software) supplied by other companies.

- **Mass Storage (Mass Storage)**

You can access the instrument from a Windows 7, Windows 8.1, or Windows 10 PC and read data from the instrument's internal storage.

- You cannot delete data or write data to the instrument's internal storage.
- You cannot format or defragment the instrument's internal storage.
- You cannot access the storage device connected to the USB ports of the instrument.
- You do not have to install a USB driver on your PC.
- If you operate the files from the instrument, the instrument will temporarily disconnect the connection from the PC so that the status of the device recognized by the PC can be refreshed.



For information about how to obtain the YOKOGAWA USB driver, contact your nearest YOKOGAWA dealer. You can also access the YOKOGAWA USB driver download website and download the driver (<https://tmi.yokogawa.com/library/>).

GP-IB

Connects the instrument to a PC using GP-IB.

Address (Address)

- You can select a value between 0 and 30.
- Each device that is connected in a GP-IB system has its own unique address. This address is used to distinguish between different devices. Therefore, you must assign a unique address to the instrument when connecting it to a PC or other device.



When the controller is communicating with the instrument or with other devices through GP-IB, do not change the address.

Notes about Connections

- Multiple cables can be used to connect multiple devices. However, no more than 15 devices, including the controller, can be connected on a single bus.
- When connecting multiple devices, you must assign a unique address to each device.
- Use cables that are 2 m or shorter in length to connect devices.
- Make sure the total length of all cables does not exceed 20 m.
- When devices are communicating, have at least two-thirds of the devices on the bus turned on.
- To connect multiple devices, use a star or daisy-chain configuration. Loop and parallel configurations are not allowed.

Network (Network)

Connects this Instrument to a PC using Ethernet.

VXI-11(VXI-11)

Select whether to allow access to the instrument using VXI-11.

- ON: Allows access
- OFF: Denies access

Socket Interface (Socket)

Select whether to allow access to the instrument using the socket interface.

- ON: Allows access
- OFF: Denies access

Timeout (Timeout)

If a connection cannot be established between the instrument and the PC within the amount of time specified here, the instrument aborts the connection process.

Selectable range: 1 s to 3600 s, Infinite



You must set TCP/IP parameters to connect this Instrument to an Ethernet network.

▶ [See here.](#)

Notes about Connections

- To connect the instrument to a PC, be sure to use straight cables and to connect through a hub or router. Proper operation is not guaranteed for a one-to-one connection using a crossover cable.
- Use one of the following types of network cable that conforms to the transfer speed of your network.
 - A UTP (Unshielded Twisted-Pair) cable
 - An STP (Shielded Twisted-Pair) cable

System Configuration (System Configuration)

You can specify the following settings.

- Date and time on the instrument
- Language (menu, message, USB keyboard)
- Measurement display (font size, number of rows outside the waveform area)
- Internal storage format
- Backlight adjustment (auto off, brightness)
- Offset cancel
- Delay cancel
- Trigger output
- USB communication feature
- Click sound on/off

Date and Time (Date/Time)

The instrument date and time.

Turning the Display On and Off (Display)

Sets whether or not to display the date and time on the instrument screen.

Display Format (Format)

Select the display format from one of the following options.

- Year/month (number)/day
- Day/month (number)/year
- Day-month (English abbreviation)-year (last two digits)
- Day month (English abbreviation) year

Date and Time (Date/Time)

Sets the date and time.

Time Difference from Greenwich Mean Time (Time Diff. GMT)

Set the time difference between the region where you are using the instrument and Greenwich Mean Time.

Selectable range: Set the time difference in the range of –12 hours 00 minutes to 13 hours 00 minutes.

For example, Japan standard time is ahead of GMT by 9 hours. In this case, set Time Hour to 9 and Minute to 00.

Checking the Standard Time

Using one of the methods below, check the standard time of the region where you are using the instrument.

- Check the Date, Time, Language, and Regional Options on your PC.
- Check the website at the following URL: <http://www.worldtimeserver.com/>



- This instrument does not support Daylight Saving Time. To set the time to Daylight Saving Time, reset the time difference from Greenwich Mean Time.
 - Date and time settings are backed up using an internal lithium battery. They are retained even if the power is turned off.
 - This instrument has leap-year information.
-

Language (Language)

Sets the language that is used in the setup menu and messages.

The available languages vary depending on the model.

USB Keyboard Language (USB Keyboard)

Sets the USB keyboard language to English. The USB keyboard can be used to enter file names, comments, etc.

Measurement Display (Measure Parameter)

You can set the size of text and the number of rows for displaying automated measurement values of waveform parameters and cursor measurement values.

Font Size (Font Size)

You can set the size of text for displaying automated measurement values of waveform parameters and cursor measurements.

- Small: Small font size
- Large: Large font size

Number of Rows outside the Waveform Area (Max Rows)

Set the number of rows outside the waveform area for displaying automated measurement values of waveform parameters and cursor measurement values.

Selectable range: 4 to 30

Internal Storage Format (Storage)

You can format the instrument's internal storage (Flash_Mem).

Format (Format)

Formats the instrument's internal storage (Flash_Mem).



If you format the internal storage, all saved data is erased.

Adjusting the Backlight (Display)

You can turn off the LCD backlight and adjust its brightness. You can prolong the backlight service life by decreasing the backlight brightness or by turning off the backlight when you do not need to view the screen.

Adjusting the Brightness (Brightness)

You can adjust the brightness in the range of 1 (darkest) to 10 (brightest).

Enable or Disable the Automatic Turning Off of the Backlight (Auto OFF)

- OFF: Disables the backlight auto-off feature.
- ON: The backlight turns off automatically when there are no key operations for a given time period. The backlight turns back on when you press any key.

Auto-off Time (Timeout)

Set the time until the backlight turns off after the last panel key operation for when the backlight auto-off feature is turned on.

Selectable range: 1 to 60 minutes

Turning Off the Backlight (Turn OFF)

You can turn off the backlight. When the backlight is off, you can turn it back on by pressing a key.

Offset Cancel (Offset Cancel)

You can select whether to apply the offset that you specified for observing analog signals to the various measured values.

For details, see "[Offset \(Offset\)](#)" in chapter 1, "Vertical Axis (Analog Signal)."

Delay Cancel (Delay Cancel)

You can select whether to apply the specified trigger delay to time measurement values.

For details, see "[Trigger Delay \(DELAY\)](#)" in chapter 4, "Triggering."

Trigger Output (TRIG OUT Polarity)

You can set the output logic for the signal transmitted from the trigger output terminal.

Positive: Outputs signals with positive logic

Negative: Outputs signals with negative logic

USB Communication (USB Function)

You can specify the communication features that are used when you connect the instrument to a PC through USB. This is the same feature as the USB communication feature of remote control.

Turning On or Off the Click Sound (Click Sound)

You can turn on or off the click sound that is generated when you operate the jog shuttle.

Overview (Overview)

You can view a list of instrument information and settings.

System Information (System Overview)

You can view the instrument model, memory size, and installed options.

Setup Information (Setup Information1, Setup Information2)

You can view a list of current settings.

Additional Option License (Option Installation)

On 4-channel models, you can add the following options after purchase. Install the options after you have purchased the license keys for them.

Options Available to 4-channel Models

/G02	User-defined computation
/G03	Power supply analysis
/F01	UART + I ² C + SPI trigger & analysis
/F02	CAN + CAN FD + LIN trigger & analysis
/F03	FlexRay trigger & analysis
/F04	SENT trigger & analysis
/F05	CXPI trigger & analysis



The SUFFIX (suffix code) inscribed in the name plate on the instrument's case indicates the installed options at the time of factory shipment. After you add options through additional option licenses, check the options on the instrument's overview screen.

Self-Test (Self Test)

You can test the keyboard and memory operations.

Test Type (Type)

You can perform the following tests.

Memory Test (Memory)

Tests whether or not the internal CPU board RAM and ROM are operating properly. If they are operating properly, "Success" appears. If an error occurs, "Fail" appears.

Keyboard Test (Keyboard)

Tests whether the front panel keys and knobs are operating correctly and whether the soft keyboard accepts input properly.

- The front panel keys are operating properly if the background color of the names of the keys that you press turns white or green.
- Knobs are operating properly if you turn them slowly, press them, or tilt them depending on the type of knob and the background color of the names or arrows changes to white or green.
- The soft keyboard is operating properly if you can enter the specified characters.

Printer Test (Printer)

Tests whether or not the optional built-in printer is operating properly. The built-in printer is operating properly if the print density is correct. If an error occurs, the print density will not be correct.



Accuracy is a service test item. Under normal circumstances, you do not need to perform these tests.

Executing a Test (Test Exec)

The selected self-test starts.

If an Error Occurs during a Self-Test

If an error occurs even after you carry out the following procedure, contact your nearest YOKOGAWA dealer.

- Execute the self-test again several times.
- Confirm whether or not the media being tested is properly inserted.
- Check that the paper is set properly in the built-in printer and that paper is not jammed.

Touch Panel (TOUCH)

Turns the touch panel feature on and off. When the touch panel feature is on, the indicator illuminates.

For the operating procedure, see the *Getting Started Guide*, IM DLM3054-03EN.

Appendix

Appendix 1 How to Calculate the Area of a Waveform

IntegTY+

Area under the positive parts: $S_1 + S_2$

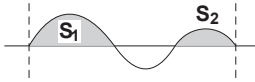

IntegTY

Area under the positive parts – area under the negative parts: $S_1 + S_3 - S_2$

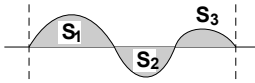

Integ for XY Display

Open

When Each Y Data Point Corresponds to a Single X Data Point

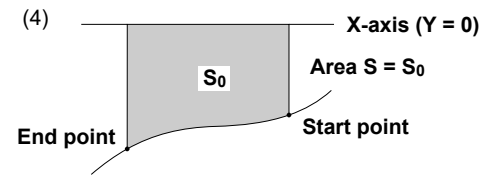
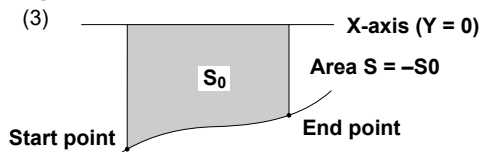
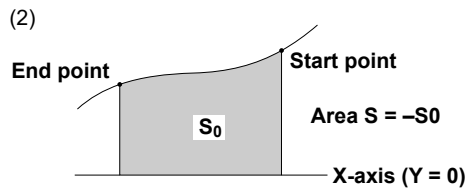
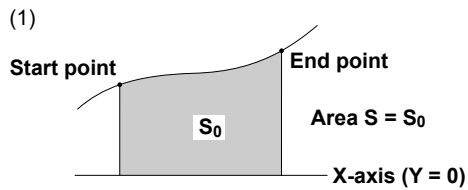

When the Waveform Extends into the Negative Side

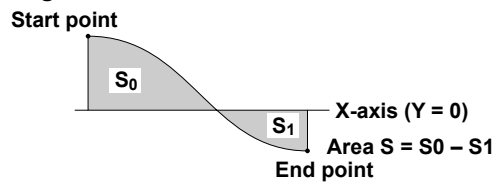

When Multiple Y Data Corresponds to X Data

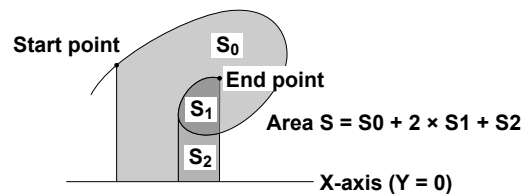
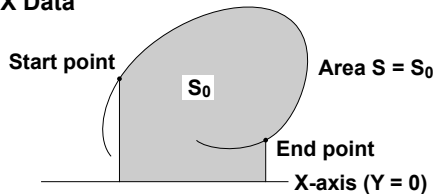

Close

Multiple Loops

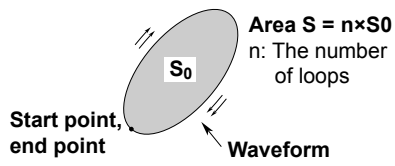

Non-Closed Curve

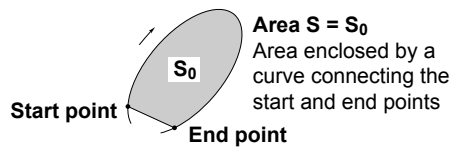

Loop Tracing a Figure-Eight

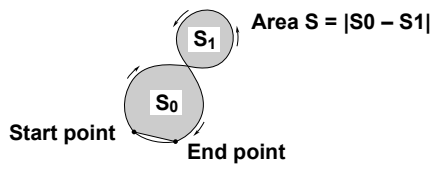

Loop Tracing a Spiral

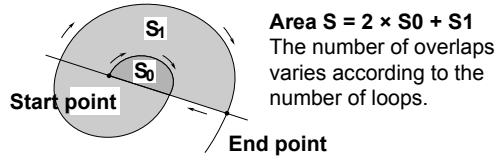

Appendix 2 User-Defined Computation

Digital Filter

Type

Type	Bandwidth
FIR	LowPass/HighPass/BandPass
IIR	LowPass/HighPass/BandPass

Filter Order

See the following table for the filter orders.

		2%	5%	10%	20%	30% (Cutoff*)
FIR	LowPass	88	36	18	9	8
	HighPass	159	65	33	17	13
IIR	LowPass	4	4	4	3	2
	HighPass	4	4	4	4	3

* The cutoff percentage is with respect to the sample rate.

Filter Response

Filter	Pass-band Ripple	Attenuation Slope	Attenuation at the Stop-band	Phase
FIR	±0.3 dB	-40 dB at 1 oct (Lowpass),	-40 dB	Linear phase
		-40 dB at -1 oct (Highpass)	-	Linear phase
IIR	0 dB	-5 dB at 1/6 oct (Lowpass),	-	Non-linear phase
		-20dB at -1oct(Highpass)	-	Non-linear phase

Examples of Filter Frequency Responses

f: Frequency (Hz)

FIR (low pass; 10% cutoff)

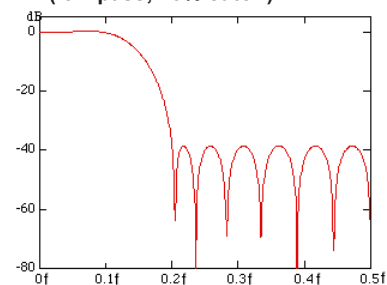

IIR (low pass; 10% cutoff)

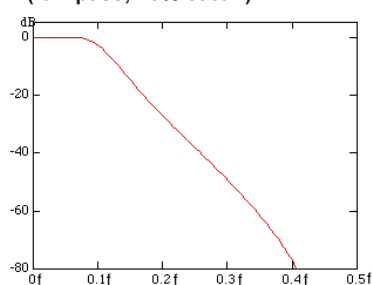

Computations take more time with higher filter orders.

Hilbert Function (HLBT)

Normally, when we analyze real-time signals, it is useful to think of these signals as the real part of functions of complex variables, and to carry out the actual signal analysis using such functions.

If the real-time signal is considered to be the real part of the function, the imaginary part can be determined with the Hilbert transform of the real part.

The Hilbert transform does not change the order of the individual variables. Hilbert transform of a time signal results in another time signal.

The Hilbert transform procedure is as follows.

When a time-domain signal is transformed, the signal is first transformed into the frequency domain through Fourier transform. Next, the phase of each frequency component is shifted by -90 degrees if the frequency is positive and $+90$ degrees if the frequency is negative. Lastly, taking the inverse Fourier transform completes the Hilbert transform.

Example

The Hilbert transform can be used to analyze an envelope waveform.

AM (amplitude modulation): $SQRT(C1 \times C1 + HLBT(C1) \times HLBT(C1))$

Demodulation of an FM Signal: $DIF(PH(C1, HLBT(C1)))$

Phase Function (PH)

Phase function $PH(X1, Y1)$ computes $\tan^{-1}(X1/Y1)$.

The phase function takes the phase of the previous point into consideration and continues to sum even when the value exceeds $\pm\pi$ (the ATAN function reflects at $\pm\pi$).

The unit is radians.

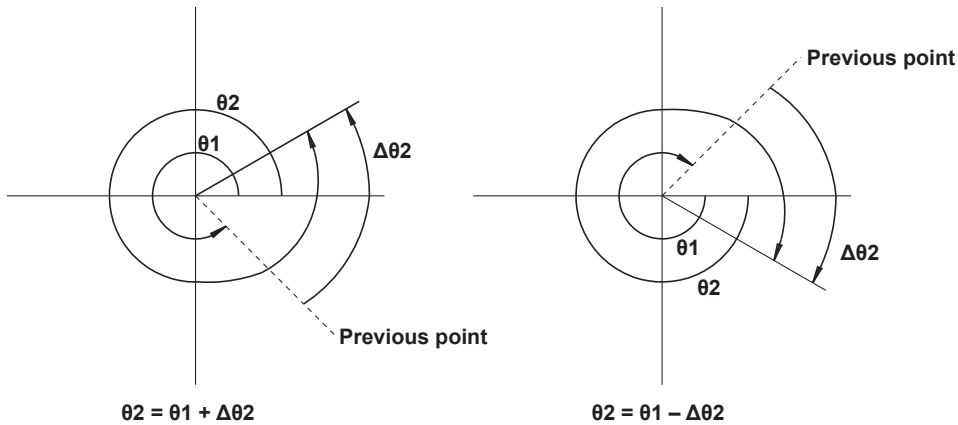

Differentiation and Integration

The computation of the differentiated value uses the 5th order Lagrange interpolation formula to derive a point of data from the five points of data before and after the target point.

The following equations use data f_0 to f_n and I_0 to I_n with respect to sampling time x_0 to x_n . The derivative and integrated values corresponding to these data points are computed as follows:

Differentiation (DIFF)

$$\text{Point } x_k \quad f_k' = \frac{1}{12h} [fk-2 - 8fk-1 + 8fk+1 - fk+2]$$

$h = Dx$ is the sampling interval (sec) (example: When 5 kHz, $h = 200 \times 10^{-6}$)

Integration(INTEG)

$$\text{Point } x_0 \quad I_0 = 0$$

$$\text{Point } x_1 \quad I_1 = \frac{1}{2} (f_0 + f_1)h$$

$$\text{Point } x_2 \quad I_2 = \frac{1}{2} (f_0 + f_1)h + \frac{1}{2} (f_1 + f_2)h = I_1 + \frac{1}{2} (f_1 + f_2)h$$

$$\text{Point } x_n \quad I_n = I_{n-1} + \frac{1}{2} (f_{n-1} + f_n)h$$

Binary Conversion(BIN)

Performs binary conversion using the specified threshold levels.

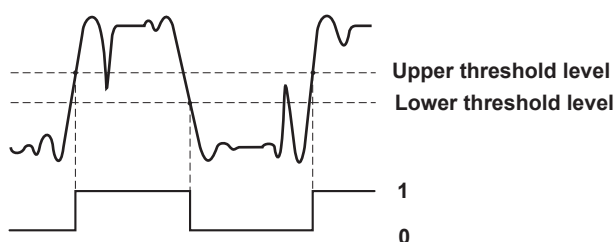

pulse width computation

The signal is converted to binary values by comparing to the preset threshold level, and the time of the pulse width is plotted as the Y-axis value for that interval.

You can set the interval to one of the settings below.

PWHH: From a rising edge to the next rising edge.

PWHL: From a rising edge to the next falling edge.

PWLH: From a falling edge to the next rising edge.

PWLL: From a falling edge to the next falling edge.

PWXX: From a rising or falling edge to the next rising or falling edge.

FV: The inverse of PWHH.

DUTYH: Duty ratio of the high side of each period of the specified waveform.

DUTYL: Duty ratio of the low side of each period of the specified waveform.

Example 1, When the Interval Is Set to PWHH

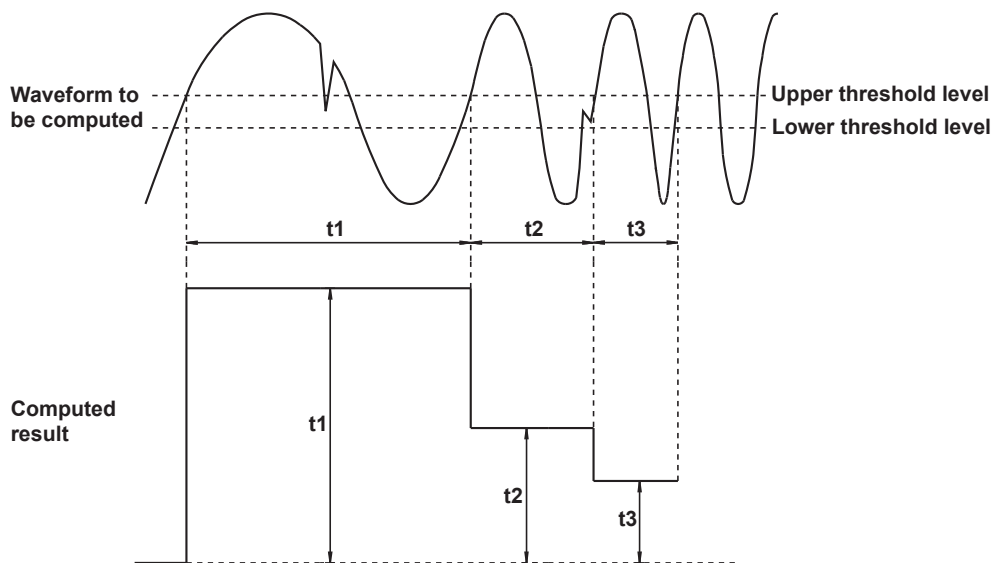

Example 2, When the Interval Is Set to DUTYH

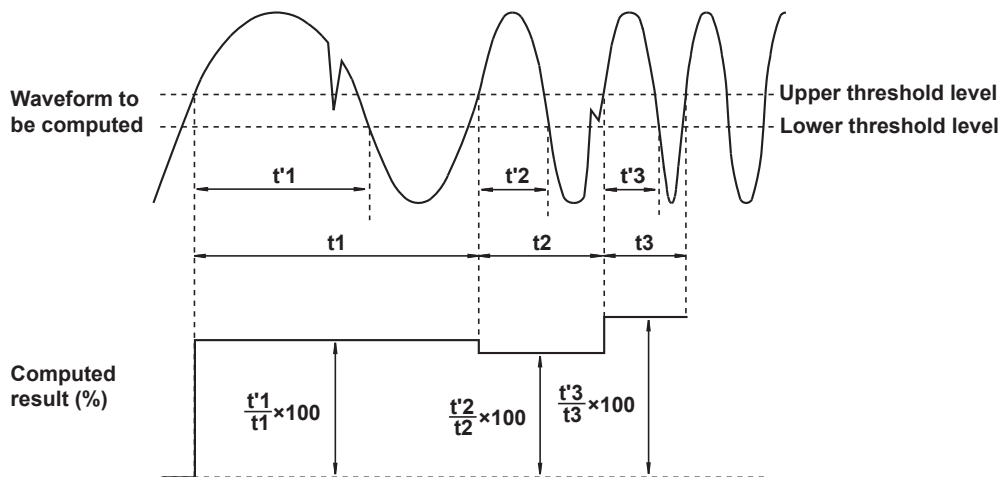

FFT Function

Each frequency component G of a linear spectrum is represented by $G=R + jI$, where R is the real part and I is the imaginary part.

Linear Spectrum

The linear spectrum can be directly determined with the FFT. Through this spectrum, the magnitude and phase of each frequency component included in the measured waveform can be found. The power spectrum and cross spectrum can also be determined from one or two linear spectra. Because the FFT is a complex function, the linear spectrum produces the real part and imaginary part of the frequency components. The magnitude and phase of the linear spectrum can also be determined from this result.

This instrument can determine the following spectra.

Item	Formula	Computation
Real part	LS-REAL	R
Imaginary part	LS-IMAG	I
Bandwidth	LS-MAG	$\sqrt{(R^2 + I^2)}$
Log magnitude	LS-LOGMAG	$20 \times \log \sqrt{(R^2 + I^2)}$
Phase	LS-PHASE	$\tan^{-1}(I/R)$

Log magnitude reference (0 dB): 1 V_{peak}

RMS Spectrum

The RMS spectrum expresses the amplitudes of the linear spectrum with RMS values. It does not contain phase information.

This instrument can determine the following spectra.

Item	Formula	Computation
Bandwidth	RS-MAG	$\sqrt{(R^2 + I^2)}/2$
Log magnitude	RS-LOGMAG	$20 \times \log \sqrt{(R^2 + I^2)}/2$

Log magnitude reference (0 dB): 1 V_{rms}

Power Spectrum

The power spectrum expresses the power (squared value) of each frequency component included in the measured signal. It is determined by taking the product of the linear spectrum and its complex conjugate. It does not contain phase information.

This instrument can determine the following spectra.

Item	Formula	Computation	
Bandwidth	PS-MAG	DC component	$R^2 + I^2$
		AC component	$(R^2 + I^2)/2$
Log magnitude	PS-LOGMAG	DC component	$10 \times \log(R^2 + I^2)$
		AC component	$10 \times \log\{(R^2 + I^2)/2\}$

Log magnitude reference (0 dB): 1 V_{rms}²

Power Spectrum Density

The power spectrum density expresses the power spectrum per unit frequency. It is determined by dividing the power spectrum by the frequency resolution Δf found during the analysis of the power spectrum. The computation varies depending on the window function.

Power spectrum density is used to compare power spectra analyzed at different frequency bands. However, it is not necessary for signals having a line spectrum such as sine waves.

This instrument can determine the following spectra.

Item	Formula	Computation	
Bandwidth	PSD-MAG	PS-MAG/ Δf	RECT window
		PS-MAG/(1.5 Δf)	HANNING window
		PS-MAG/(3.19693 Δf)	Flattop window
Log magnitude	PSD-LOGMAG	$10 \times \log \text{PS-MAG}/\Delta f$	RECT window
		$10 \times \log \text{PS-MAG}/(1.5\Delta f)$	HANNING window
		$10 \times \log \text{PS-MAG}/(3.19693\Delta f)$	Flattop window

Log magnitude reference (0 dB): 1 V_{rms}²

Cross Spectrum

The cross spectrum is determined from two signals. It is found by taking the product of the linear spectrum of one signal (G_y) and the complex conjugate (G_x^*) of the linear spectrum of the other signal (G_x).

If the linear spectra of the two signals are represented by

$$G_x = R_x + jI_x$$

$$G_y = R_y + jI_y$$

then the cross spectrum G_{yx} is

$$\begin{aligned} G_{yx} &= G_y \times G_x^* \\ &= (R_y + jI_y)(R_x - jI_x) = R_{yx} + jI_{yx} \end{aligned}$$

$$\text{where } R_{yx} = R_y R_x + I_y I_x$$

$$I_{yx} = R_x I_y - R_y I_x$$

This instrument can determine the following spectra.

Item	Formula	Computation	
Real part	CS-REAL	DC component	R_{yx}
		AC component	$R_{yx}/2$
Imaginary part	CS-IMAG	DC component	I_{yx}
		AC component	$I_{yx}/2$
Bandwidth	CS-MAG	DC component	$\sqrt{(R_{yx}^2 + I_{yx}^2)}$
		AC component	$\sqrt{(R_{yx}^2 + I_{yx}^2)}/2$
Log magnitude	CS-LOGMAG	DC component	$10 \times \log \sqrt{(R_{yx}^2 + I_{yx}^2)}$
		AC component	$10 \times \log (\sqrt{(R_{yx}^2 + I_{yx}^2)}/2)$
Phase	CS-PHASE		$\tan^{-1}(I_{yx}/R_{yx})$

Transfer Function

The transfer function expresses the frequency responses of the input to and the output from the transfer system. The transfer function is determined by the ratio of the output linear spectrum (G_y) and the input spectrum (G_x) at each frequency. Also, as can be seen from the following equation, the transfer function can be defined as the ratio of the cross spectrum of the input and output (G_{yx}) and the input power spectrum (G_{xx}).

$$\begin{aligned} \text{Transfer function} &= G_y/G_x = (G_y \times G_x^*)/(G_x \times G_x^*) = G_{yx}/G_{xx} \\ &= (R_{yx} + jI_{yx})/(R_x^2 + I_x^2) \end{aligned}$$

The instrument can determine the following items.

Item	Formula	Computation
Real part	TF-REAL	$R_{yx}/(R_x^2 + I_x^2)$
Imaginary part	TF-IMAG	$I_{yx}/(R_x^2 + I_x^2)$
Bandwidth	TF-MAG	$\sqrt{(R_{yx}^2 + I_{yx}^2)}/(R_x^2 + I_x^2)$
Log magnitude	TF-LOGMAG	$20 \times \log \sqrt{(R_{yx}^2 + I_{yx}^2)}/(R_x^2 + I_x^2)$
Phase	TF-PHASE	$\tan^{-1}(I_{yx}/R_{yx})$

The magnitude of the transfer function shows the ratio of the magnitudes of the output linear spectrum and the input linear spectrum while the phase shows the phase difference of the two.

Coherence Function

The coherence function expresses the ratio of the output power generated by the input signal to the transfer system and the total output power.

$$\text{Coherence function} = G_{yx} \times G_{yx}^*/(G_{xx} \times G_{yy})$$

Item	Formula	Computation
Bandwidth	CH-MAG	$(R_{yx}^2 + I_{yx}^2)/(G_{xx} \times G_{yy})$

If the output signal is due entirely to the input signal, the coherence function becomes 1. As the ratio decreases, it falls below 1. Thus, the coherence function always takes on a value between 0 and 1.



On one data acquisition, the coherence function becomes 1 across all frequencies. Make sure to take the frequency average of the computation.

Time Windows

You can select from rectangular, Hanning, or flattop time windows.

The rectangular window is best suited to transient signals, such as impulse waves, which attenuate completely within the time window. The Hanning and flattop windows allow continuity of the signal by gradually attenuating the parts of the signal located near the ends of the time window down to the 0 level. Hence, they are best suited to continuous signals. The Hanning window provides a higher frequency resolution compared to the flattop window. However, the flattop window has a higher level of accuracy. When the waveform being analyzed is a continuous signal, consider the above characteristics in selecting the proper window to be applied.

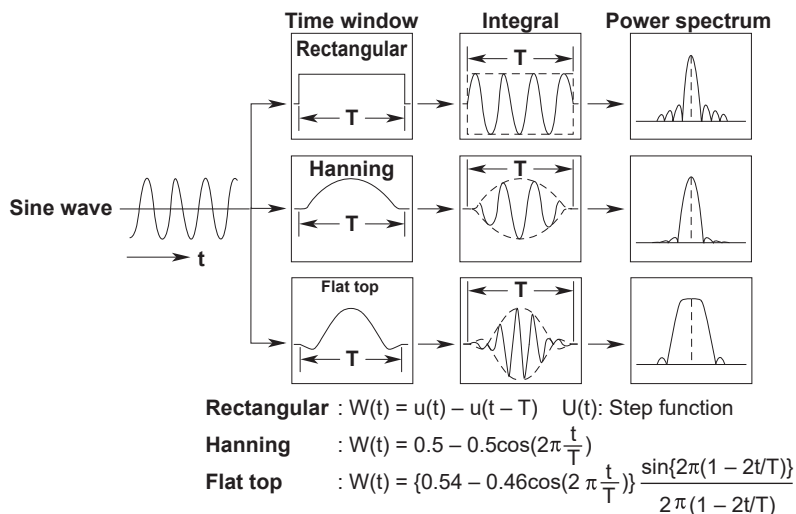

Notes When Executing the FFT Computation

Computation is normally performed on the sampled data in the acquisition memory. However, for waveforms that have been acquired in envelope mode, computation is performed on the maximum and minimum values per acquisition interval.

Appendix 3 ASCII Data File Format

The instrument can save waveform data to ASCII files. The format of such files is given below.

	A	B	C	D	E
1	Header Size	15			
2	Model Name	DLM3000			
3	Comment				
4	BlockNumber	1	1	1	1
5	TraceName	CH1	CH2	CH3	CH4
6	BlockSize	12500	12500	12500	12500
7	VUnit	V	V	V	V
8	SampleRate	6250000	6250000	6250000	6250000
9	HResolution	1.60E-07	1.60E-07	1.60E-07	1.60E-07
10	HOffset	-1.00E-03	-1.00E-03	-1.00E-03	-1.00E-03
11	HUnit	s	s	s	s
12	DisplayBlockSize	12500	12500	12500	12500
13	DisplayPointNo.	1	1	1	1
14	Date	2018/9/25	2018/9/25	2018/9/25	2018/9/25
15	Time	20:52.3	20:52.3	20:52.3	20:52.3
16					
17	Data 	6.30E-02	-1.00E-01	1.00E-01	1.00E-01
18		7.70E-02	-1.00E-01	1.00E-01	-2.00E-01
19		8.70E-02	0.00E+00	1.00E-01	1.00E-01
20		9.10E-02	-4.00E-01	2.00E-01	0.00E+00
21		9.40E-02	-2.00E-01	0.00E+00	-2.00E-01
22		9.60E-02	0.00E+00	1.00E-01	0.00E+00
23					

Header Size	The number of header lines.
Model Name	The model name.
Comment	Comment attached at the time the data file was saved.
BlockNumber	Block number for this group. When the block numbers vary depending on the waveform, this is the maximum block number.
TraceName	Name of each waveform.
BlockSize	The number of data points in one block for each waveform.
VUnit	Each waveform's Y-axis unit (this has no effect on the data).
SampleRate	The sample rate at the time of waveform acquisition.
HResolution	Each waveform's X-axis conversion coefficient, HResolution. $X\text{-axis value} = H\text{Resolution} \times (\text{Data No.} - 1) + H\text{Offset}$
HOffset	Each waveform's X-axis conversion coefficient, HOffset. $X\text{-axis value} = H\text{Resolution} \times (\text{Data No.} - 1) + H\text{Offset}$
HUnit	Each waveform's X-axis unit (this has no effect on the data).
DisplayBlockSize	The length of the data displayed on the screen (the display record length).
DisplayPointNo.	This number shows what point in memory is displayed on the left-most side of the display record length.
Date	Date when waveform acquisition completed.
Time	Time when waveform acquisition completed.

Appendix 4 TCP and UDP Port Numbers

The TCP and UDP port numbers that are used on the Ethernet interface of the instrument are listed below.

TCP Port Numbers

Port Number	Description	Used For
20	File Transfer [Default Data]	FTP server, FTP client*
21	File Transfer [Control]	FTP server, FTP client
25	Simple Mail Transfer Protocol	SMTP client
515	-	LPR client
111	-	
1024	-	Instrument control through the Ethernet interface
1025	-	

UDP Port Numbers

Port Number	Description	Used For
67	Bootstrap Protocol Server	DHCP client
68	Bootstrap Protocol Client	(listen port)
111	-	Instrument control through the Ethernet interface
123	Network Time Protocol	SNTP client

- * The port number when FTP passive mode is disabled. When FTP passive mode is enabled, you can set any port number. When FTP passive mode is disabled, connections are established from the server. If you are connecting the instrument from behind a firewall, enable FTP passive mode.

Appendix 5 How Power Measurement Items Are Determined

The power measurement feature is available on models with the /G03 option. The following table shows how the power measurement items are determined or the equations that are used.

Measurement Item	Methods of Determination and Equation		
	U+pk	U-pk	Up-p
Voltage U [V] Maximum U+pk Minimum U-pk Amplitude Up-p True rms value Urms DC component Udc AC component Uac Rectified mean value calibrated to the rms value Umn Rectified mean value Urmn	Maximum (same as waveform parameter "Max")	Minimum (same as waveform parameter "Min")	Bandwidth (same as waveform parameter "P-P")
	Urms	Udc	Uac
	$\sqrt{\frac{1}{T} \int_0^T u(t)^2 dt}$	$\frac{1}{T} \int_0^T u(t) dt$	$\sqrt{U_{rms}^2 - U_{dc}^2}$
	Umn	Urmn	
	$\frac{\pi}{2\sqrt{2}} \frac{1}{T} \int_0^T u(t) dt$	$\frac{1}{T} \int_0^T u(t) dt$	
Current I [A] Maximum I+pk Minimum I-pk Amplitude Ip-p True rms value Irms DC component Idc AC component Iac Rectified mean value calibrated to the rms value Imn Rectified mean value Irmn	Maximum (same as waveform parameter "Max")	Minimum (same as waveform parameter "Min")	Bandwidth (same as waveform parameter "P-P")
	Irms	Idc	Iac
	$\sqrt{\frac{1}{T} \int_0^T i(t)^2 dt}$	$\frac{1}{T} \int_0^T i(t) dt$	$\sqrt{I_{rms}^2 - I_{dc}^2}$
	Imn	Irmn	
	$\frac{\pi}{2\sqrt{2}} \frac{1}{T} \int_0^T i(t) dt$	$\frac{1}{T} \int_0^T i(t) dt$	
Apparent power S [VA]	Urms•Irms		
Active power P [W]	$\frac{1}{T} \int_0^T u(t) \cdot i(t) dt$ u(t) • i(t): Instantaneous power		
Reactive power Q [var]	$\sqrt{S^2 - P^2}$		
Load circuit Impedance Z [Ω]	$\frac{U_{rms}}{I_{rms}}$		
Power factor λ	$\frac{P}{S}$		
Watt-hours [Wh] Wp Wp+ Wp- Abs.Wp	$\int_0^T u(t) \cdot i(t) dt$ Wp is the sum of positive and negative watt hours. Wp+ is the sum of positive P (consumed watt-hours). Wp- is the sum of negative P (watt-hours returned to the power supply). Abs.Wp is the sum of Wp+ and Wp- (the sum of absolute watt-hours).		
Ampere-hours [Ah] q+ q- Abs.q	$\int_0^T i(t) dt$ q is the sum of positive and negative Idc (ampere-hours). q+ is the sum of positive Idc (ampere-hours). q- is the sum of negative Idc (ampere-hours). Abs.q is the sum of q+ and q- (the sum of absolute ampere-hours).		
Average frequency Avg Freq [Hz]	Average frequency (same as waveform parameter "Avg Freq")		

T: measurement time period, u(t): sampled data of the voltage, i(t): sampled data of the current

Appendix 6 Trigger and Detected Points of SENT Signals

The following table shows the trigger and detected points of SENT signals.

Trigger/search type	Trigger/detected point				
	Normal, with SYNC/CAL error, with S&C error	Nibble Number with error	NDV in S&C with error	NDV in DataNDV with error	NDV in CRC with error
Every Fast CH	End of S&C of the relevant frame				
Fast CH S&C	End of S&C of the relevant frame		Not triggered or searched	End of S&C of the relevant frame	
Fast CH Data	End of the last piece of data of the relevant frame			Not triggered when there is an NDV error in the data being compared	End of the last piece of data of the relevant frame
Every Slow CH	End of S&C of the last fast channel of the relevant slow channel				
Slow CH ID/Data					
Successive CAL Pulses (Preferred Option)	Trigger point: End of S&C of the succeeding frame Detected point: End of S&C of the relevant frame				
Successive CAL Pulses (Option 2)	End of S&C of the relevant frame				
Error Nibble Number	Trigger point: End of S&C of the succeeding frame Detected point: End of S&C of the relevant frame				
Nibble Data Value (NDV)	End of the relevant nibble				
Fast CH CRC	End of the relevant CRC				
Status and Communication (S&C)	End of the relevant S&C		Not triggered or searched	End of the relevant S&C	
Slow CH CRC	End of S&C of the last fast channel of the relevant slow channel				

For the figure of the SENT signal frame format, see the explanation of SENT trigger.

► [See here.](#)

Appendix 7 Firmware Version and New Features

The following table contains new features that are available for each firmware version. If you are using an older version, you will not be able to use all the features described in this manual. To view the firmware version, press the Overview soft key on the UTILITY menu and check Firmware Version on the Overview screen that is displayed.

Version	Suffix Code	New Features	Manual Edition Number
1.00 and later	Standard	New	1st Edition

Index

Symbols

	Page
ΔT cursor	11-2
$\Delta T \& \Delta V$ cursor	11-3
ΔV cursor	11-2
λ	17-10

Numerics

	Page
3 wire	4-69
4 wire	4-69

A

	Page
A->B(N) trigger	4-78
Accum Time	7-4
accumulation	7-4
accumulation time	7-4
ACK mode	4-33
ACQ count	6-3
acquisition mode	6-2
action	5-1
action count	5-2
action in averaging mode	6-5
action mode	5-1
action-on-trigger, execution	5-3
action-on-trigger, notes on	5-7
action to perform when the conditions are met	5-1
active power	17-15
active (SPI)	4-70
active(user define)	4-72
additional options	22-9
addition, subtraction, and multiplication	9-3
address data (I2C)	4-65
address (I2C)	4-65
A Delay B trigger	4-77
ampere-hours	17-16
analysis results, saving (serial bus)	15-4
analysis source waveform (FFT)	10-1
analyzing and searching (CAN)	15-7
analyzing and searching (CAN FD)	15-9
analyzing and searching (CXPI)	15-17
analyzing and searching (FlexRay)	15-5
analyzing and searching (I2C)	15-31
analyzing and searching (LIN)	15-14
analyzing and searching (SENT)	15-23
analyzing and searching source waveform (serial bus)	15-2
analyzing and searching (SPI)	15-33
analyzing and searching, turning on and off (serial bus)	15-1
analyzing and searching (UART)	15-28
analyzing and searching (user-defined serial bus)	15-35
angle cursor	11-4
angle unit	11-4
apparent power	17-15
applicable class	17-9
Area2 setting	12-12
area (XY)	8-2
assignment	2-3, 2-5
A trigger	4-78
attenuation constant	6-3
attenuation ratio	1-3
attributes (file)	20-17
auto calibration	22-3
auto level mode	4-1

automated measurement of waveform parameters, saving results of	20-6
automatic zero adjustment	1-4
automatic zero adjustment of current probes	1-4
auto measurement, notes on	12-13
auto measurement on/off	12-1
auto mode	4-1
auto scaling	9-7
auto scroll (zoom)	13-2
auto setup	4-24, 22-1
auto setup (CAN)	15-7
auto setup (CAN FD)	15-10
auto setup (CXPI)	15-18
auto setup (FlexRay)	15-5
auto setup (I2C)	15-31
auto setup (LIN)	15-14
auto setup (SENT)	15-23
auto setup (serial bus signal)	15-2
auto setup (SPI)	15-33
auto setup (UART)	15-29
average count	6-3
average (history)	18-2
averaging mode	6-2

B

	Page
background transparency	19-6
backlight adjustment	22-8
bandwidth	1-5
bandwidth limit	1-5
bar graph display	17-10
beep sound	5-1
BIN	App-5
binary computation	App-5
bit and bus display order	2-5
bit assignments	2-3
bit order (SPI)	4-70
bit order (UART)	4-63
bit pattern (CAN)	4-31
bit pattern (CAN FD)	4-39
bit rate (CAN)	4-35
bit rate (CAN FD)	4-41
bit rate (FlexRay)	4-28
bit rate (LIN)	4-47
bit rate (UART)	4-63
bit setup	2-1
Break Synch	4-44, 4-45
broadcasting system	4-74
B trigger	4-77, 4-78
B TRIG key	4-77
bus	2-3
bus bit assignments	2-3
bus channel	4-28, 15-5
bus display	2-3
bus setup (CAN)	15-7
bus setup (CAN FD)	15-9
bus setup (CXPI)	15-17
bus setup (FlexRay)	15-5
bus setup (LIN)	15-14
bus setup (SENT)	15-23
bus setup (SPI)	15-33
bus setup (UART)	15-28
bus setup (User Define)	15-35
byte order	4-32

Index

C		Page
Calc setup	12-12	
calculation using waveform parameters	12-12	
calibration	22-3	
CAN bus signal, analyzing and searching	15-7	
CAN Bus Trigger	4-30	
CAN FD bus signal, analyzing and searching	15-9	
CAN FD bus trigger	4-38	
CAN FD standard	15-9	
center	9-7	
channels, loading to	20-14	
clear trace	22-3	
click sound on/off	22-8	
clock, auto adjustment	21-6	
clock (CXPI)	4-49, 15-19	
clock on/off (User Define)	4-72	
coherence function	App-8	
collector-emitter saturation voltage	17-3	
color	7-2	
combination	4-77	
combination (pattern)	4-12	
combination trigger	4-77	
commercial power supply	4-4	
communication interface types	22-4	
comparison condition (CAN)	4-32	
comparison condition (CXPI)	4-50	
comparison condition (LIN)	4-46	
comparison condition (pattern)	4-11	
comparison condition (SENT_Slow CH ID/Data)	4-58	
comparison range	4-33	
comparison start position (I2C)	4-66	
comparison start position (SPI)	4-70	
compatible printers (USB)	19-2	
computation mode	9-1	
computation source waveform	9-1	
continuous	12-7	
counter (CXPI)	15-19	
count (S1)	9-4	
count type	9-4	
CRC (CAN)	4-30	
CRC (CAN FD)	4-38, 15-11	
CRC (CXPI)	4-49, 15-19	
cross spectrum	App-8	
CS (SPI)	4-70	
current (rms)	17-16	
Cursor1 and Cursor2 linkage	11-4	
cursor jumping	11-5	
cursor measurement, notes on	11-5	
cursor measurement, turning on and off	11-1	
cursor measurement (XY)	8-2	
cursor movement	11-4	
cursor type (FFT)	10-4	
CXPI bus signal, analyzing and searching	15-17	
CXPI bus trigger	4-48	
cycle	12-8	
cycle count (FlexRay)	4-26	
cycle mode (automated measurement of waveform parameters)	12-5	
cycle trace	12-8	
cyclic statistical processing	12-8	
D		Page
Data1/Data2 (FlexRay)	4-26	
Data1/Data2 (SPI)	4-70	
data bit rate (CAN FD)	4-41	
data (CAN)	4-31	
data (CAN FD)	15-12	
Data (CAN FD)	4-39	
data (CXPI)	4-50, 15-21	
data format (UART)	4-63	
data frame (CAN)	4-31, 4-36	
data frame (CAN FD)	4-39, 4-43, 15-12	
data (I2C)	4-66	
data length (CXPI)	4-49, 15-19	
data (LIN)	4-46	
data, loading	20-14	
data pattern (CAN)	4-32	
data pattern (CAN FD)	4-40, 15-12	
data pattern (CXPI)	4-50, 15-21	
data pattern (LIN)	4-46	
data, saving	20-2	
data type (SENT)	4-57	
data (UART)	4-62	
date and time	22-6	
decoded display (CAN)	15-7	
decoded display (CAN FD)	15-10	
decoded display (CXPI)	15-18	
decoded display (FlexRay)	15-5	
decoded display (I2C)	15-31	
decoded display (LIN)	15-14	
decoded display (SENT)	15-24	
decoded display (SPI)	15-34	
decoded display (UART)	15-29	
decoded display (User Define)	15-35	
default setup	22-2	
default values, resetting to	22-2	
delay	4-7	
delay between waveforms, measurement	12-4	
delay cancel	4-7	
delay canceling	4-7	
delay setup	12-4	
demagnetization	1-4	
demagnetization and automatic zero adjustment of current probes	1-4	
DEMAG & Zero Cal	1-4	
deskew	1-4, 2-5, 17-1	
deskew (logic)	2-5	
destination type	19-1	
detail	15-4	
detail display (decoded results)	15-4	
detected point	14-8	
detected point number	14-8	
determination source waveform	5-3	
DHCP	21-2	
DIFF	App-5	
differentiation	App-5	
digital filter	App-3	
direct setting	9-6	
display format	7-1	
display format (zoom)	13-1	
display interpolation	7-2	
display mode	18-2	
display on/off	1-1	
display order	2-5	
display size of logic signal	2-1	
distal/mesial/proximal	12-6	
divided window (XY)	8-1	
DLC	4-31	
DNS	21-2	
E		Page
edge	4-4	
edge count	9-5	
edge OR trigger	4-8	
edge search	14-1, 14-4	

edge trigger	4-4	fundamental waveform, changing.....	5-5
email address	21-4	Fund Current	17-10
e-mail transmission.....	5-1		
enable (User Define)	4-72	G	Page
Endian (CAN)	4-32	general call	4-67
Endian (CAN FD).....	4-40, 15-13	GO/NO-GO determination	5-3
Endian (CXPI).....	4-51, 15-22	GO/NO-GO determination, execution.....	5-3
enhanced	4-2	GO/NO-GO determination, notes on	5-7
Enhanced (auto measurement).....	12-12	GP-IB	22-5
enhanced parameter measurement	12-12	gradation mode.....	7-4
envelope mode	6-2	graticule	7-3
error (CAN)	4-30	grouping.....	15-28
error (CAN FD).....	4-38, 15-11		
error (CXPI)	4-49, 15-19	H	Page
error (FlexRay)	4-25	hard copy	19-2
error frame (CAN).....	4-30, 4-37	harmonic.....	17-8
error frame (CAN FD).....	4-38, 4-44, 15-11	harmonic analysis.....	17-8
error (LIN).....	4-45	harmonic component	17-8
error (SENT).....	4-59	harmonic grouping.....	17-10
error type (CAN)	4-30	harmonic order	17-8
error type (FlexRay).....	4-25	harmonics	17-8
error type (LIN)	15-16	HF rejection	4-6
error (UART).....	4-62	HF rejection (TV trigger)	4-77
Ethernet communication.....	21-1	high and low, how to determine	12-6
EUT's active power.....	17-10	highlight display (history).....	18-2
EUT's fundamental current.....	17-10	high resolution mode	6-3
EUT's power supply voltage	17-9	high speed CAN	4-37
every data (UART).....	4-62	Hilbert function.....	App-4
Every Fast CH (SENT)	4-56	Hi resolution.....	6-3
Every PTYPE(CXPI).....	15-20	histogram frequency (waveform).....	16-1
Every Slow CH (SENT)	4-58	histogram, saving	20-7
EveryStart (I2C).....	4-65	histograms, turning on or off (waveform).....	16-1
external trigger signal	4-4	history	12-9
		history waveform computation.....	9-10
F	Page	history waveform, searching.....	18-3
Fast CH Data (SENT).....	4-57	HLBT	App-4
Fast CH S&C (SENT).....	4-56	Holdoff	4-7
FD standard.....	4-38, 15-9	horizontal scale value	10-4
FFT conditions.....	10-2	horizontal sync frequency.....	4-77
FFT function	App-7	Horiz.Scale	10-4
FFT points, number of	10-3	HS mode.....	4-69
FFT results, saving	20-7		
FFT setup	10-2	I	Page
FFT, turning on and off	10-1	I2C bus signal, analyzing and searching.....	15-31
FFT window	7-1	I2C bus trigger	4-64
field number	4-75	I2t.....	17-12
file and folders, deleting.....	20-16	IBS (CXPI).....	4-49, 15-19
file information	20-16	ID (CAN)	4-31
file operation.....	20-16	ID (CAN FD)	4-39, 15-12
file path.....	20-16	ID (CXPI)	4-49, 4-51, 15-20
files and folders, copying and moving	20-16	ID/Data (CAN)	4-31
files and folders, renaming	20-16	ID/Data (CAN FD).....	4-39, 15-11
filter type, selection.....	9-3	ID/Data (CXPI).....	4-49, 15-20
fine grid display.....	7-3	ID/Data (FlexRay).....	4-25
fixed stuff (CAN FD)	4-38, 15-11	ID/Data (LIN)	4-45
FlexRay bus signal, analyzing and searching	15-5	ID (LIN).....	4-45
FlexRay bus trigger	4-24	ID OR (CAN).....	4-34
format	2-3	ID OR (CAN FD).....	4-41
frame format (CAN).....	4-31	ID OR (CXPI).....	4-51
frame format (CAN FD)	4-39, 15-11	ID OR (FlexRay).....	4-27
frame information.....	4-49, 15-20	ID OR (LIN).....	4-47
frame skip	4-75	IIR filter	9-4
frame start	4-24, 4-25	IIR Lowpass/IIR Highpass	9-4
framing (CXPI).....	4-49, 15-19	image files, attachment.....	21-4
FTP server.....	21-3	impedance	17-15
fundamental frequency.....	17-8	Include R/W (I2C).....	4-66, 15-31
fundamental wave	17-8	Indicator (FlexRay).....	4-25

Index

indicator (measure).....	12-5, 17-16
information.....	19-2, 19-6, 20-6
initial computation point.....	9-6
initial point.....	9-6
input coupling.....	1-3
input range.....	4-6
INTEG.....	App-5
integration.....	9-4, App-5
Integ (S1).....	9-4
intensity.....	7-2
interharmonics.....	17-9
internal storage format.....	22-7
interpolation mode.....	6-4
interval trigger.....	4-21
inverted display.....	1-4
ISO.....	4-38, 15-9

J Page

Joule integral.....	17-12
Joule integral waveform (I2t), displaying.....	17-13
judgment conditions.....	5-3

L Page

label display on/off.....	1-5, 9-6
label name.....	1-5, 9-6
language.....	22-7
latch (user define).....	4-73
level setup.....	17-5
license.....	22-9
LIN bus signal, analyzing and searching.....	15-14
LIN bus trigger.....	4-44
linear interpolation.....	7-2
linear scaling.....	1-4
linear scaling on/off.....	1-4
line number.....	4-74
linkage.....	11-4
list display (CAN).....	15-8
list display (CAN FD).....	15-10
list display (CXPI).....	15-19
list display (decoded results).....	15-4
list display (FlexRay).....	15-6
list display (harmonics).....	17-11
list display (I2C).....	15-32
list display (LIN).....	15-15
list display (SENT).....	15-24
list display (SPI).....	15-34
list display (statistical processing).....	12-9
list display (UART).....	15-30
list search (history).....	18-3
list size.....	15-4
list, sorting.....	20-16
logic signal waveform on/off.....	2-1
low speed CAN.....	4-37
LPR server.....	21-6

M Page

magnification.....	13-2
mail server.....	21-4
mail transmission test.....	21-4
main window display (zoom).....	13-2
manual scaling.....	9-7
mapping.....	7-2
marker cursor.....	11-3
marker cursor (FFT).....	10-4
marker display format.....	11-3
mark (search).....	14-7
measurement location indicator.....	12-5

measurement source waveform (auto measurement).....	12-1
measurement source waveform (cursor).....	11-1
measurement source window.....	12-1
measurement time period.....	12-1
MeasureSetup (FFT).....	10-4
MeasureSetup (histogram).....	12-11
MeasureSetup (waveform histogram).....	16-2
MeasureSetup (XY).....	8-2
message/signal.....	4-33
MSB/LSB (CAN).....	4-33
MSB/LSB (CAN FD).....	4-40, 15-13
MSB/LSB (CXPI).....	4-51, 15-22
multiple files and folders, selecting.....	20-16

N Page

Network.....	22-5
network drive.....	21-5
network printer.....	21-6
nibble order.....	4-57, 15-23
Nogo count.....	5-2
noise rejection.....	4-6
noise rejection (logic).....	2-2
NON ACK.....	4-67
non-ISO.....	4-38, 15-9
no response (CXPI).....	15-20
normal mode.....	4-1, 6-2
normal (print).....	19-2
normal statistical processing.....	12-7
N Single.....	4-1
N Single mode.....	4-1
number of analyzable and searchable frames or data bytes.....	15-1

O Page

offset.....	1-5
offset (B).....	1-5
offset cancel.....	1-6
offset, resetting.....	1-5
on-resistance.....	17-3
operation.....	9-3
operator.....	9-3
order (SENT).....	4-57, 15-23
Over 25 watt.....	17-10
overview.....	22-9

P Page

parity (CXPI).....	4-49, 15-19
passive.....	21-5
passive mode.....	21-5
Pattern No.....	14-8
pattern search.....	14-2, 14-5
pattern trigger.....	4-9
peak cursor (FFT).....	10-5
PH.....	App-4
phase function (PH).....	App-4
phase shift.....	9-3
polarity.....	4-5
polarity (pulse width).....	4-13
polarity (rise/fall time).....	4-14
polarity (runt).....	4-16
polarity (timeout).....	4-17
polarity (window).....	4-18
polarity (window OR).....	4-20
polygonal zone.....	5-6
port number.....	App-11
POSITION knob (trigger position).....	4-6
POSITION knob (vertical position knob).....	1-2, 2-1

power.....	17-10	resolution	4-77
power factor.....	17-10, 17-15	restart	12-7
power measurement.....	17-14	restart (statistical processing).....	12-7
power spectrum.....	App-7	Result Window.....	14-7
power spectrum density.....	App-7	rise/fall time trigger	4-14
power supply analysis	17-1	rms (current).....	17-16
power waveform display.....	17-6	rms (voltage).....	17-15
printer type (network).....	19-4	roll mode display.....	3-1
printer type (USB).....	19-3	rotary	9-5
print mode.....	19-2	rotary count.....	9-5
probe attenuation.....	1-3, 4-6	RUN/STOP	6-5
probe setup.....	17-2	RUN/STOP key, when disabled.....	6-5
probe type.....	1-3	RUN/STOP operation during accumulation.....	6-5
Probe Zero Cal	1-4	runt trigger	4-16
Protection	20-16, 20-17		
PTYPE (CXPI).....	4-49, 15-20	S	Page
pulse interpolation	7-2	safe operating area analysis.....	17-7
pulse width computation.....	App-6	sample point (CAN)	4-35
pulse width search.....	14-4, 14-6	sample point (CAN FD)	4-41, 15-9
pulse width trigger	4-13	sample point (LIN).....	4-47, 15-14
		sample point (UART).....	4-63, 15-28
Q	Page	sample rate.....	3-1
qualification (window OR).....	4-20	sampling mode	6-4
		save mode.....	19-5
R	Page	SCALE knob	1-1, 2-1
range	4-6	scale value display	7-3
ranging.....	9-7	scaling	9-7
RDS (on).....	17-3	scaling coefficient (A)	1-5
RDS(on) x I2.....	17-4	SCL.....	4-64
reactive power	17-15	screen capture, saving	19-5, 20-5
realtime.....	6-4	screen image, printing/saving.....	5-1
real-time sampling mode	6-4	scroll speed	13-2
recessive level.....	4-35	SDA	4-64
record length.....	3-1, 6-1	search (CAN).....	15-8
rectangular zone.....	5-4	search (CAN FD).....	15-11
Ref.....	9-1	search conditions.....	14-4
reference angle.....	11-4	search (CXPI).....	15-19
reference condition	5-3	search execution	14-8
reference cursor (degree).....	11-4	search (FlexRay)	15-6
reference level during automated measurement.....	12-6	search (I2C).....	15-32
reference levels	17-5, 17-16	search (LIN).....	15-15
reference level, unit of	12-6	search range.....	14-8
reference range, setting using waveform parameters	5-6	search (SENT).....	15-27
reference range type	5-3	search settings (serial bus).....	15-2
reference setup.....	11-4	search, skipping.....	14-7
reference time (interval).....	4-21	search source waveform	14-1
reference time (pattern).....	4-12	search (SPI).....	15-34
reference time (pulse width).....	4-13, 14-5	search type	14-1
reference time (rise/fall time).....	4-15	search (UART).....	15-30
reference time (runt).....	4-16	search (User Define)	15-35
reference time (window)	4-19	search waveform display	14-7
reference values (a, b) (CAN).....	4-32	second byte	4-67
reference values (a, b) (CAN FD).....	4-40, 15-13	self-test.....	22-10
reference values (a, b) (CXPI).....	4-50, 15-21	sensitivity	9-7
reference values (a, b) (LIN).....	4-46	SENT signal, analyzing and searching.....	15-23
reference values (a, b) (SENT_Slow CH ID/Data)	4-59	SENT trigger.....	4-56
reference waveform.....	9-2	serial bus analysis results ((Others - Serial Bus(SENT/UART/ I2C/SPI)), saving.....	20-11
reference waveform, loading	9-2	serial bus analysis results, saving	20-8
reference waveform, loading into	20-14	serial bus trend color	7-2
Ref levels.....	12-6	serial bus trigger	4-23
Ref Value	11-4	serial clock	4-64
remote control.....	22-4	serial data	4-64
remote frame (CAN).....	4-31, 4-36	setting information	22-9
remote frame (CAN FD)	4-39, 4-44, 15-12	setting information, including.....	19-6, 20-6
repetitive.....	6-4	settings when trigger changes.....	12-7
repetitive sampling mode.....	6-4	Set to	9-6
replay (history).....	18-4	setup data loading	20-15
replay speed.....	18-4		

Index

setup data, saving	20-5	time scale, record length, sample rate, relationship between	6-4
setup data, viewing the contents of	20-15	timestamps, list of	18-2, 20-7
sign	4-32	timestamps, saving the list of	20-7
sine interpolation	7-2	time window	10-3
SINGLE	6-5	total loss	17-3
single mode	4-1	touch panel	22-10
size (CAN FD)	4-39, 15-12	T Range1/T Range2	12-1
size (CXPI)	4-50, 15-21	transfer function	App-8
sleep (CXPI)	15-22	transfer time difference, correcting	17-1
slope	4-5	trend display (SENT)	15-25
Slow CH ID/Data (SENT)	4-58	trend display (trend)	15-4
Slow CH type (SENT)	4-58	Trend/Histogram	12-10
smoothing	9-4	trend/histogram display (statistical processing)	12-10
snapshot	22-2	trigger combination	4-77
snapshot waveform data, saving	20-6	trigger delay	4-7
snapshot waveforms, loading	20-15	trigger hold-off	4-7
SNTP server	21-6	trigger level	4-5
SOA	17-7	trigger mode	4-1
SOF (CAN)	4-30	trigger output	22-8
SOF (CAN FD)	4-38, 15-11	trigger point (CAN)	4-36
SOF (CXPI)	4-48, 15-19	trigger point (CAN FD)	4-43
source waveform display	10-4	trigger point (CXPI)	4-53
spectrum type	10-2	trigger point (FlexRay)	4-29
SPI bus signal, analyzing and searching	15-33	trigger point (LIN)	4-48
SPI bus trigger	4-69	trigger point (SENT)	4-61
split	8-1	trigger point (SPI)	4-71
start byte	4-69	trigger point (UART)	4-64
start condition	4-65	trigger position	4-6
Start/End Point	14-8	trigger slope	4-5
start (I2C)	4-65	trigger slope (interval)	4-21
state display	2-4	Trigger Sources	4-4
statistical processing	12-7	trigger type	4-2
statistical processing, execution	12-8	trigger type (CAN)	4-30
statistical processing of history waveforms	12-9	trigger type (CAN FD)	4-38
statistical processing type	12-7	trigger type (CXPI)	4-48
statistics	12-7	trigger type (FlexRay)	4-24
storage device	20-1	trigger type (I2C)	4-64
stuff (CAN)	4-30	trigger type (LIN)	4-44
stuff (CAN FD)	4-38, 15-11	trigger type (SENT)	4-56
stuff error (CAN)	4-37	trigger type (UART)	4-62
stuff error (CAN FD)	4-44	TrigLevelChange	12-7
sub type	10-2	T sample (CXPI)	4-52, 15-17
switching loss analysis	17-2	TV trigger	4-74
SW loss	17-2	type	10-2
symbols data, loading	20-15		
sync guard frequency	4-77		
system configuration	22-6		
system information	22-9		
system voltage	17-9		
T	Page	U	Page
TCP/IP	21-2	UART signal, analyzing and searching	15-28
threshold level (logic)	2-2	UART trigger	4-62
time condition (interval)	4-21	unit	9-7
time condition (pattern)	4-12	USB	22-4
time condition (pulse width)	4-13	USB keyboard language	22-7
time condition (rise/fall time)	4-15	user authentication	21-4
time condition (runt)	4-16	user-defined bus signals, analyzing and searching	15-35
time condition (window)	4-19	user-defined computation	9-7
TIME/DIV knob	3-1	user-defined serial bus trigger	4-72
time-domain waveform display	8-1	User-Defined Trigger	4-24
time measurement items	12-3		
timeout	21-4		
timeout search	14-4, 14-6	V	Page
timeout trigger	4-17	Vce (SAT)	17-3
TimeRange (auto measurement)	12-1	VCE(sat) x I	17-4
TimeRange (FFT)	10-3	vertical position	1-2
time scale	3-1	vertical position of logic signal	2-1
		vertical position (reference waveform)	9-2
		vertical scale	1-1
		vertical scale value	10-4
		vertical zoom	13-3
		Vert.Scale	10-4

V-Mag	13-3
voltage measurement items	12-2
voltage (rms).....	17-15
V-Position	13-3
VT display.....	8-1, 10-4
VT waveform display window	7-1

W Page

wakeup/sleep (CXPI).....	4-51, 15-22
watt-hours.....	17-15
waveform acquisition count	6-3
waveform acquisition (RUN/STOP)	6-5
waveform acquisition (SINGLE)	6-5
waveform acquisitions, maximum number of	18-2
waveform assignment.....	7-2
waveform color	7-2
waveform data loading	20-14
waveform data, saving.....	5-1, 20-2
waveform (FFT), how to display	10-3
waveform intensity.....	7-3
waveform inversion.....	1-4
waveform on/off.....	1-1
waveform parameters, automated measurement of.....	12-2
waveform vertical position	1-2
waveform zone	5-4
waveform zone, confirmation.....	5-5
waveform zones and polygonal zones, loading.....	20-15
waveform zones, saving.....	20-6
Window OR trigger	4-20
window trigger	4-18
window type.....	7-1
wiring system.....	4-69

X Page

X-axis and Y-axis source waveforms.....	8-1
XY waveform display	8-1
XY window.....	7-1

Z Page

Zone No.....	5-4
zoom link	13-3
zoom link, turning on and off	15-4
zoom position	13-3
zoom source waveform	13-2
zoom, turning on and off.....	13-1
zoom window, specifying.....	14-7