

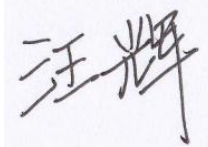

SPECIFICATION



<i>Device Name</i>	
<i>Part No.</i>	
<i>Customer</i>	
<i>Date</i>	

Customer Confirm	Approved by	Checked by	Issued by
			

LED Bar and Plane Display

(14 × 7 mm Light Bar)

Part No.	<i>YDUG-120M</i>	
Dice Color	Chip Material	Color of Segment
High Super Green	AlGaInP	White Diffused

1. Features

Emitting area : 14×7 (mm)

High efficiency, low power consumption.

Excellent characters appearance.

Solid state reliability.

Categorized for luminous intensity.

This product doesn't contain restriction Substance comply RoHS Standard.

2. Descriptions

The YDUG-120M have uniform emitting light.

These devices are made with white segments and white surface.

3. Applications

Audio equipment or Instrument panels.

General use for digital indicators.

Multimedia product.

4. Package Dimensions

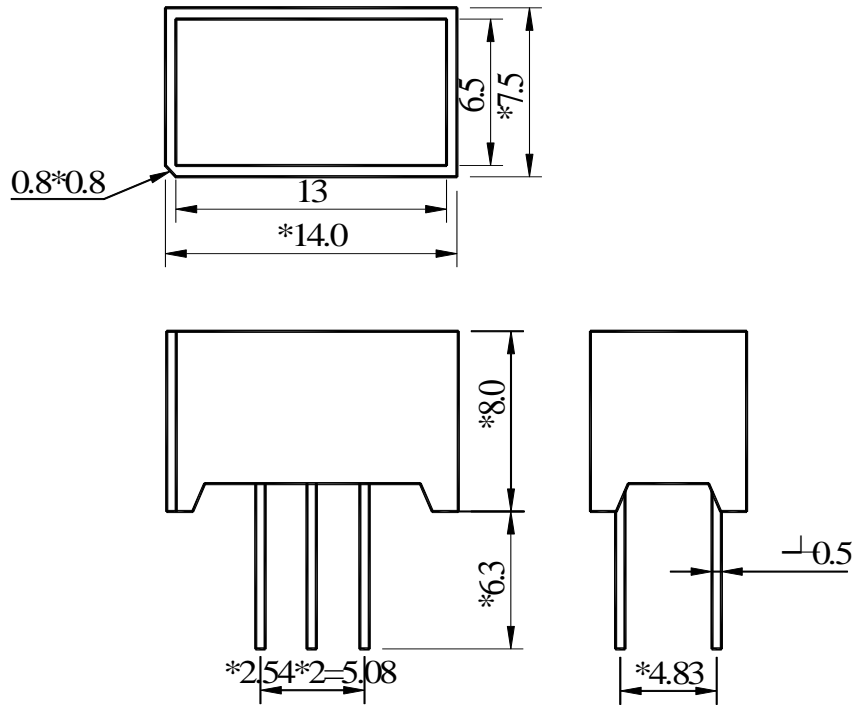

Note :

1. All dimensions are in millimeters(mm)
2. Tolerance is ± 0.25 mm unless otherwise noted
3. Protruded resin under flange is 1.5mm Max LED.

5. Internal Circuit Diagram

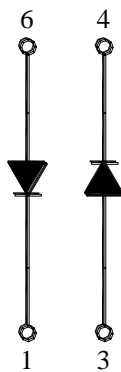

6. Absolute Maximum Rating (Ta = 25℃)

Parameter	Symbol	Maximum Rating	Unit
Power Dissipation/dot	P _M	50	mW
Peak Forward Current /dot (Duty 1/10@ 1KHz)	I _{FP}	80	mA
Continuous Forward Current/dot	I _F	20	mA
Recommend Use Current/dot	I _F		mA
Reverse Voltage	V _R	5	V
Operation Temperature	T _{opr}	-35℃ ~ 80℃	⊙
Storage Temperature	T _{stg}	-40℃ ~ 85℃	⊙
Soldering Temperature (time≤5 seconds.)	T _{sol}	260±5	⊙

Note : 1. This is the limit current . It is not allowed to use when the product work continuously.

2. It is recommended that the product is driven by TTL,CMOS.

3. Soldering time≤5 seconds.

7. Electron-Optical Characteristics (Ta = 25℃)

Parameter	Symbol	Typ.	Max.	Unit	Test Condition
Luminous Intensity/dot	I _v	18		mcd	I _F =10 mA
Forward Voltage/dot	V _F	2.0	2.5	V	I _F =20 mA
Reverse Current/dot	I _R		30	μA	V _R =5V
Peak Wavelength	λ _p	570		nm	I _F =20 mA
Spectral Line Half Width	Δλ	30		nm	I _F =20 mA

8. Reliability

1) Test Items and Conditions

No.	Test Item	Test Conditions	Sample	Ac/Re
1.	Temperature Cycle	-40 ±5 [◎] →25 ±5 [◎] →85 ±5 [◎] →25 ±5 [◎] (30min, 5min, 30min, 5min) 20 Cycles	20	0/1
2.	High Temperature Storage	Ta : 100 ±5 [◎] Test time = 1,000 hrs. (-24 hrs., +72 hrs.)	20	0/1
3.	High Temperature & High Humidity Working	Ta : 85±5 [◎] , RH : 85±5%, I _F = 10mA/seg. Test time = 500 hrs. (-24 hrs., +72 hrs.)	20	0/1
4.	Low Temperature Storage	Ta : -40±5 [◎] Test time = 1,000 hrs. (-24 hrs., +72 hrs.)	20	0/1
5.	Operating Life Test	Connect with a power I _F = 10mA/seg. Ta = 25 ±5 [◎] Test time = 1,000 hrs. (-24 hrs., +72 hrs.)	20	0/1
6.	Solder Resistance	T.sol = 260 ±5 [◎] one time Dwell Time = 5 ±1sec., distance 3mm	20	0/1
7.	Thermal Shock	-40 ±5 [◎] →85 ±5 [◎] (15min, 15min) 20Cycles	20	0/1

2) Criteria of judging the damage

Item	Symbol	Test condition	Criteria for judgement	
			Min.	Max.
Forward voltage	VF	I _F = 10mA/Seg.	/	U.S.L*1.1
Reverse current	IR	VR=5V	/	15uA
Luminous intensity	IV	I _F = 10mA/Seg.	L.S.L*0.7	/
Wave length	λD/λP	I _F = 10mA/Seg.	/	U.S.L±2nm
Appearance	/	View check	No mechanical damage	

* U.S.L: Upper standard level

L.S.L: Lower standard level

9. Typical Characteristic

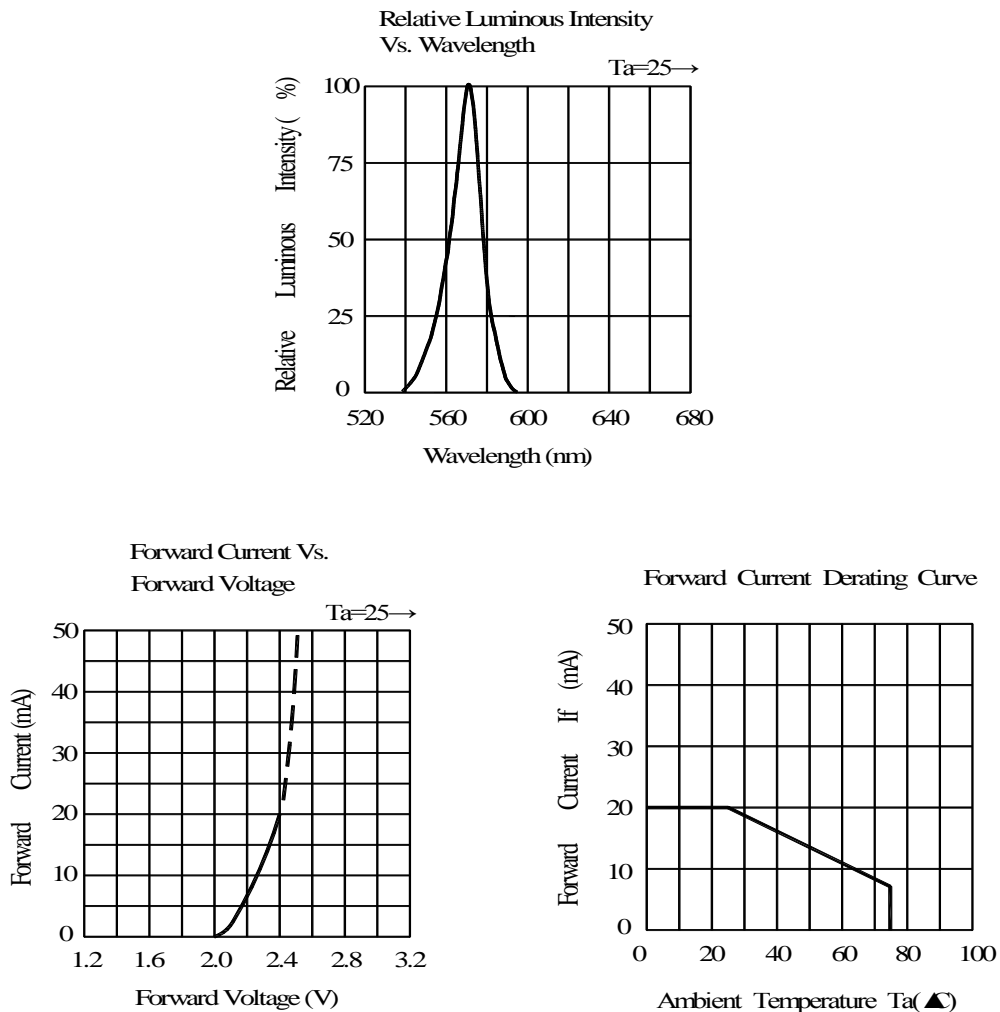

10. Storage and application notices

1) Storage

- (1) Before opening package : the LEDs should be kept at 18-30°C, related humidity : 30-70%RH. They should be used out within 3 mothes.
- (2) LEDs should be used out within 24 hrs. after opening package to avoid the lead frame's corrode.
- (3) The internal box can not be contacted with ground to prevent absorption of moisture
- (4) No acid, alkali, salt, corrosive and explosive gas; away from sunlight and keep the environment clean.

2) Application

- (1) Do not use any unknown chemical liquid to clean LED, it will damage the LED resin surface; use the alcohol under the room temperature if necessary but less than 1 min;
- (2) When forming lead frame, the lead frame should be bent at a point at least 2mm from the base of epoxy. The forming should be done before soldering which can avoid epoxy's broken and internal structure's damage. Forming must be operated by the specific jig or the qualified operator to make sure the lead frame and distance are as same as the circuit board. Specific is shown as below,

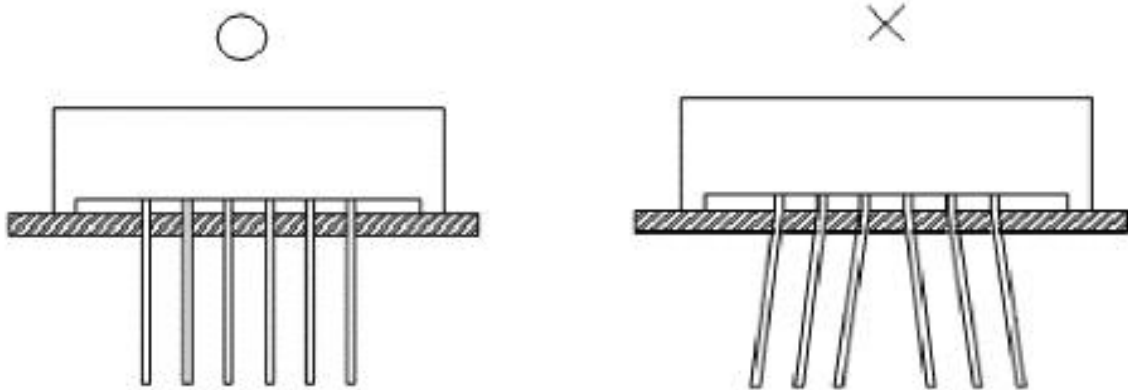

Mark : "o" means correct, "x" means incorrect.

- (3) Do not apply any bending stress to the surface of the LED. The stress to the surface may damage the surface ink color and internal connection which causes the electric character & appearance's failure.
- (4) Soldering
 - a. Soldering iron power : under 30W; soldering temperature: $295^{\circ}\text{C}\pm 5^{\circ}\text{C}$; soldering time : within 3sec.(only 1time) ;
 - b. Soldering temperature in solder machine : $250^{\circ}\text{C}\pm 10^{\circ}\text{C}$; soldering time : within 5sec.
 - c. Soldering temperature during wave soldering process : $230^{\circ}\text{C}\pm 10^{\circ}\text{C}$, soldering time : within 5sec.
- (5) The LEDs should be soldered at the coordinated position on the PCB; the distance from soldering point to epoxy resin should be 3mm at least. If the 2nd soldering process required, 3mins must be left to ensure the high temperature status can return to room temperature. But the recommended soldering time is only 1time in principle.
- (6) If solder the LEDs on one PCB by the soldering iron; do not solder the different lead frames of one LED, but solder in proper sequence;
- (7) Note of Electrical matter :

- ① One-way conduction, LED does not allow the reverse driving;
 - ②
 - a. LED is a kind of constant current component which can not be lighted by the constant voltage mode; a smaller voltage fluctuation can cause the large current fluctuation which causes the failure of LED;
 - b. Each LED should be drove under constant current mode if in a parallel circuit design, otherwise, the colour and brightness will be nonuniform;
 - c. When the environmental temperature rising, the LED junction temperature will rise, internal resistance will decrease, so the current will be increased by the constant voltage power which short the life span;
 - ③ If the brightness of lighting source can meet the requirement, we recommend using the driving current less than the rated current, in order to improve the product's reliability;
- (8) LED is a kind of electrostatic sensitive devises, anti-static measures have to be processed during storage and operation
- ① LED production workshop should lay anti-static floor and ground connection, the work table have to use the anti-static materials and cover a table mater with the surface resistance of 10^6 - $10^9\Omega$
 - ② Production machine: REFLOW, SMT equipment, electric iron, test equipment; all the equipments must be well grounded, and the grounding alternating current impedance should be less than 1.0Ω . A fan need to be installed on the equipments and production processes that easy to generate static electricity; the operators must wear anti-static clothing, shoes, wristband, and gloves, etc. in the process;
 - ③ LEDs must be contained in the anti-static box, and all the package material should be the anti-static materials;
- (9) The details electronic characters can refer to our product specification.

11. Notes

- 1) Above specification may be changed without notice. We will reserve authority on material change for above specification.
- 2) When use this product, please observe the absolute maximum ratings and the instructions for the specification sheets. We assume no responsibility for any damage resulting from using of the product which does not comply with the instructions included in the specification sheets.