

DATASHEET & RELIABILITY DATA

OPS10A Series

(주)오디피

Open Digital Power Corp.

Contents

- Introduction	-----	3~5 page
1. Feature		
2. Environment		
3. Model Name Structure		
4. Pin Assignments & Function		
5. Output Voltage Adjustment		
- Datasheet	-----	6~23 page
1. Internal Circuit Architecture		
2. Maximum Ratings		
3. Electrical Characteristics		
4. General Characteristics		
5. Environment		
6. Characteristic data		
- Reliability Data	-----	24~27 page
1. MTBF		
2. Environmental Stress Test		
- Application Sheet	-----	28~33 page
1. Basic Connection		
2. Input Section		
3. Output Section		
4. Protection Section		
5. Environment		
6. Outline Dimensions		

MAX. Output Current 10A Non-Isolated POL DC-DC Converter

OPS10A Non-Isolated POL DC-DC Converter

- Introduction

1. Features



- Available RoHS compliant
- Long Life Design
- Safety standard : CB, CE approvals pending
- MTBF : $5.1 * 10^5$ hours
- Non-Isolated POL DC-DC Converter
- Input Voltage : 3.5V – 5.5V, 8V – 14V
- Wide Output Voltage Adj. Range (via external resistor)
OPS10A-5 : 0.65V – 3.63V
OPS10A-12 : 0.8V – 5.5V
- Output Current Range : 0A – 10A
- High Efficiency to 95%
- Remote on/off Control Function
- Remote +Sense (+Vo)
- Built-in over current protection
- Built-in short-circuit protection
- Built-in over temperature protection
- Wide operating temperature range
- Warranty : 3years

2. Environment

- Operating Temperature : $-40^{\circ}\text{C} \sim 85^{\circ}\text{C}$
- Operating Humidity : 5% ~ 95% RH (Non condensing)
- Storage Temperature : $-40^{\circ}\text{C} \sim 125^{\circ}\text{C}$
- Cooling : Free-Air Convection or Forced air

3. Model Name Structure

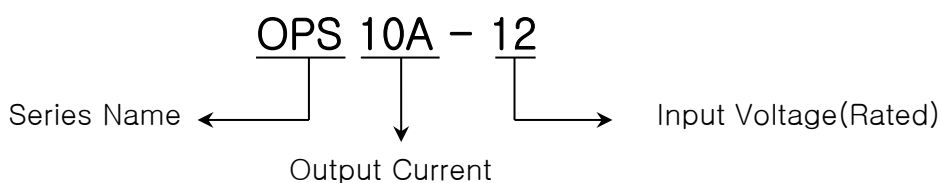

4. Pin assignments & Function



PIN No.	NAME	FUNCTION
1	+Vout	Positive terminal for Vout
2	+Vout	Positive terminal for Vout
3	+Sense	Remote Sense (+Vo)
4	+Vout	Positive terminal for Vout
5	COM	The common ground of Vin & Vout
6	COM	The common ground of Vin & Vout
7	+Vin	Positive terminal for Vin
8	+Vin	Positive terminal for Vin
9	N.C	No Connection
10	TRM	Vout variation by external resister
11	CNT	Remote on/off Control

5. Output Voltage Adjustment

OPS10A series offers a wide range of variable output voltage. Wide output voltage variation range is an important feature that can improve the inconvenience of having to purchase a different output voltage module. The output voltage of OPS10A-5 can be adjusted from 0.65V to 3.63V by an external resistor R_T . If R_T is opened, the output voltage is 0.65V.

The output voltage of OPS10A-12 can be adjusted from 0.8V to 5.5V by an external resistor R_T . If R_T is opened, the output voltage is 0.8V.

< External resistor(R_T) connecting & calculating method >

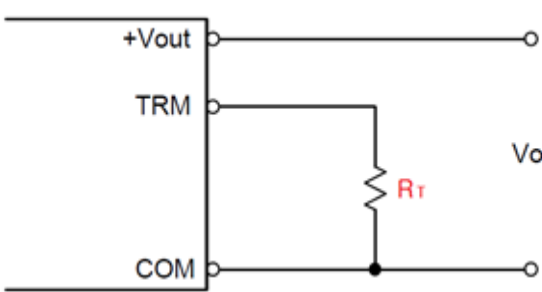

$$R_T = \frac{6}{V_o - 0.65} \text{ [k}\Omega\text{]} \quad (\text{OPS10A-5})$$

$$R_T = \frac{6}{V_o - 0.8} \text{ [k}\Omega\text{]} \quad (\text{OPS10A-12})$$

< Vo adj. Range >		
Model No.	Vin	Vo
OPS10A-5	DC 3.5V - 4.5V	DC 0.65V - 2.75V
	DC 4.5V - 5.5V	DC 0.65V - 3.63V
OPS10A-12	DC 8V - 14V	DC 0.8V - 5.5V

< External Resistor Values for setting output voltage >

OPS10A-5			OPS10A-12		
Vo	R_T	Vin	Vo	R_T	Vin
0.65V	open	DC 3.5V - 5.5V	0.8V	open	DC 8.0V - 14.0V
0.8V	40.2k Ω		1.0V	30.0k Ω	
1.0V	16.9k Ω		1.5V	8.66k Ω	
1.2V	11.0k Ω		2.0V	4.99k Ω	
1.5V	6.98k Ω		2.5V	3.48k Ω	
1.8V	5.23k Ω		3.3V	2.4k Ω	
2.0V	4.42k Ω		4.0V	1.87k Ω	
2.5V	3.24k Ω		4.5V	1.62k Ω	
3.3V	2.26k Ω	DC 4.5V - 5.5V	5.0V	1.43k Ω	
3.63V	2.0k Ω		5.5V	1.3k Ω	

R_T is recommended resistor of 1% standard values to consideration of the output voltage accuracy.

- Datasheet

1. Internal Circuit Architecture

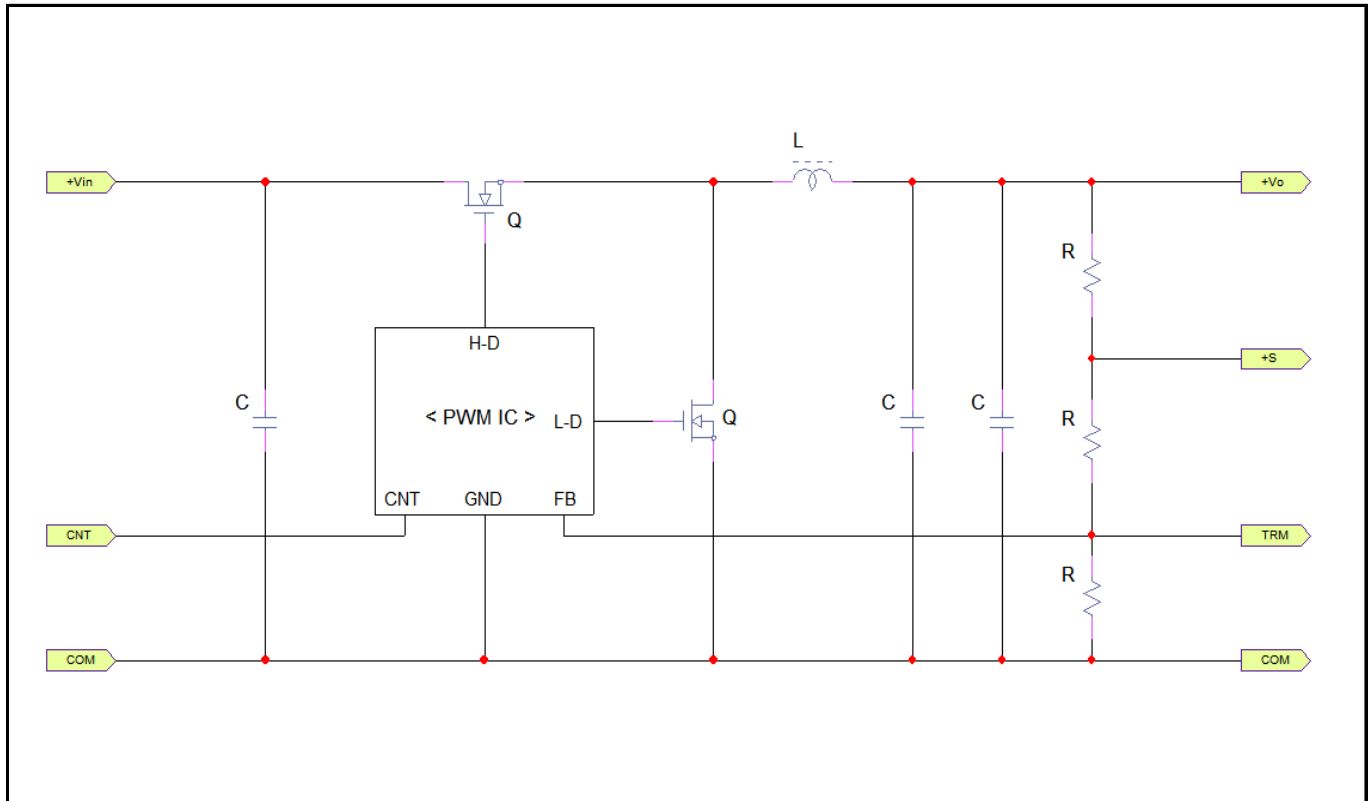

2. Maximum Ratings

Characteristics		Symbol	Min.	Typ.	Max.	Unit
Input Voltage	OPS10A-5	Vin	3.5	-	5.5	VDC
	OPS10A-12		8.0	-	14.0	
Output Voltage	OPS10A-5 (Vin : 3.5V - 4.5V)	Vin	0.65	-	2.75	VDC
	OPS10A-5 (Vin : 4.5V - 5.5V)		0.65	-	3.63	
	OPS10A-12		0.8	-	5.5	
Output Current	OPS10A-XX	Io	0	-	10	A
Operating Ambient Temperature		Ta	-40	-	85	°C
Storage Temperature		Tstg	-40	-	125	°C

3. Electrical Characteristics

3.1. Input Section

Ta : 25°C

Characteristics		Condition	Min.	Typ.	Max.	Unit
Operating Input Voltage	OPS10A-5	Io : 0A – 10A	3.5	5.0	5.5	VDC
	OPS10A-12		8.0	12.0	14.0	
Input Current	OPS10A-5	Vin : 3.5V Vo : 2.5V, Io : 10A			7.75	A
	OPS10A-5	Vin : 4.5V Vo : 3.3V, Io : 10A			7.75	
	OPS10A-12	Vin : 8.0V Vo : 5.0V, Io : 10A			6.60	
No Load Input Current	OPS10A-5	Vin : Rated Voltage Vo : 3.3V, Io : No Load			40	mA
	OPS10A-12	Vin : Rated Voltage Vo : 5.0V, Io : No Load			70	
Pre-bias Remote off Input Current	OPS10A-5	Vin : Rated Voltage Vo : 3.3V, Io : 10A			3	mA
	OPS10A-12	Vin : Rated Voltage Vo : 5.0V, Io : 10A			3	
Input Reflected Ripple Noise	OPS10A-5	Vin : Rated Voltage Vo : 3.3V, Io : 10A BW : 20MHz	-	-	30	mV (peak to peak)
	OPS10A-12	(Refer to note 1)	-	-	50	

3.2. Output Section

Ta : 25°C

Characteristics		Condition	Min.	Typ.	Max.	Unit
Output Voltage Accuracy		Vin : Rated Voltage Io : No Load	-	-	±2	%
Line Regulation		Vin : min. <-> Max. Io : No Load	-	-	±0.2	%
Load Regulation		Vin : Rated Voltage Io : 0A <-> 10A	-	-	±1	%
Transient Response		Vin : Rated Voltage Vo : 3.3V Io : 5A Load step (Tr/Tf : 50us)	-	-	100	mV (peak to peak)
Output Ripple Noise	OPS10A-5	Vin : Rated Voltage Vo : 3.3V, Io : 5A BW : 20MHz	-	-	30	mV (peak to peak)
	OPS10A-12	(Refer to note 2)	-	-	50	

Characteristics		Condition	Min.	Typ.	Max.	Unit
Output Current	OPS10A-5		0	-	10	A
	OPS10A-12					
Start - Up Time			2	-	3	ms
Turn - on Overshoot		Vin : Rated Voltage Io : 10A	-	-	20	mV
Efficiency	OPS10A-5	Vin : Rated Voltage Vo : 3.3V, Io : 10A	-	95	-	%
	OPS10A-12	Vin : Rated Voltage Vo : 5.0V, Io : 10A	-	94	-	

< Note. Test Condition >

1. Input Reflected Ripple & Noise

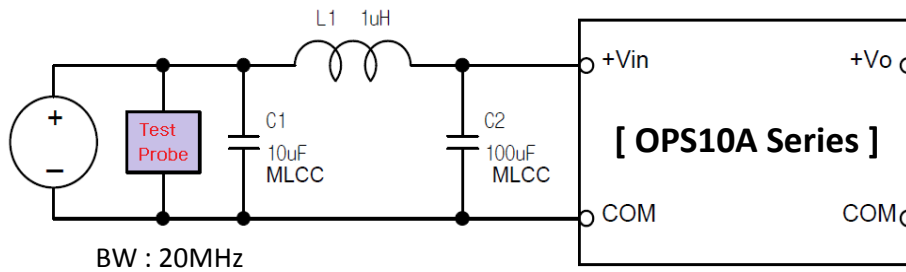

2. Output Ripple & Noise

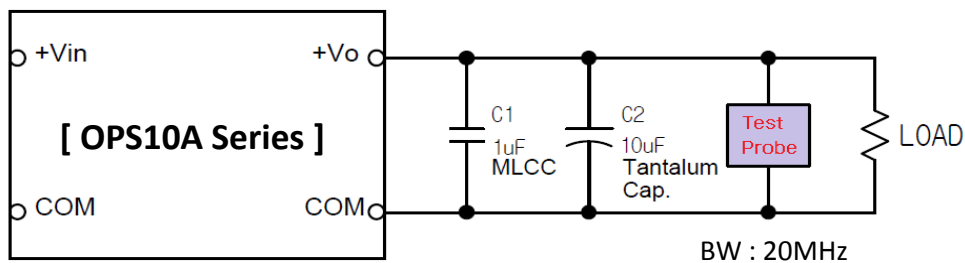

3.3. Protection Section

Ta : 25°C

Characteristics		Condition	Min.	Typ.	Max.	Unit
OCP (Over Current Protection)	OPS10A-5	Protection type : Hiccup mode and auto recovery	125	-	185	%
	OPS10A-12		115	-	185	
SCP (Short Circuit Protection)	OPS10A-5	Protection type : Hiccup mode and auto recovery	-	30	-	Seconds
	OPS10A-12		-	30	-	
OTP (Over Temperature Protection)	OPS10A-5	OTP Point : Case of IC1 Protection type : Shutdown and auto recovery	-	-	135	°C
	OPS10A-12		-	-	135	
UVLO (Under Voltage Lock Out)	OPS10A-5 (Vo : 0.65V - 2.5V)	Module 'on'	2.7	-	3.0	V
		Module 'off'	2.6	-	2.9	
	OPS10A-5 (Vo : 3.3V - 3.63V)	Module 'on'	3.6	-	4.0	
		Module 'off'	3.2	-	3.5	
	OPS10A-12	Module 'on'	2.7	-	5.8	
		Module 'off'	2.6	-	5.4	

4. General Characteristics

Characteristics		Condition	Min.	Typ.	Max.	Unit
Remote on/off control (CNT)	Module 'on'	CNT : Active Low 'on' : Low or Open 'off' : High or Short +Vin	0	-	1.2	V
	Module 'off'		1.8	-	Vin	
External Trim Adj. Range	OPS10A-5	TRM Pin (by an external Resistor)	0.65	3.3	3.63	V
	OPS10A-12		0.8	5.0	5.5	
Switching Frequency				300		kHz
MTBF (MIL-HDBK-217F)			5.1 x 10 ⁵			hrs
Dimension (L x W x H)			50.80 x 7.60 x 13.97			mm
Weight			-	-	9	grams

5. Environment

Characteristics	Symbol	Min.	Typ.	Max.	Unit
Operating Temperature Range (Refer to derating curve)	Ta	-40	-	85	°C
Operating Humidity (non Condensing)		5	-	95	%RH
Storage Temperature	Tstg	-40	-	125	°C

< Derating Curve >

a. OPS10A-5 (@ Vin : 5V)

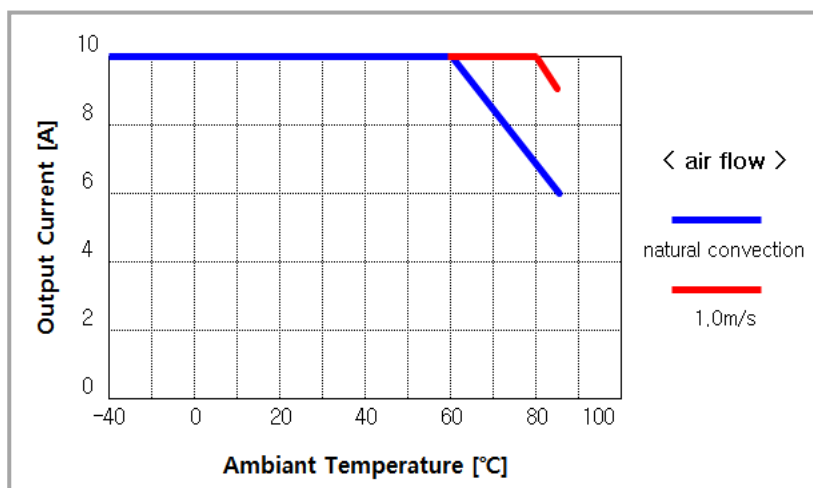

b. OPS10A-12 (@ Vin : 12V)

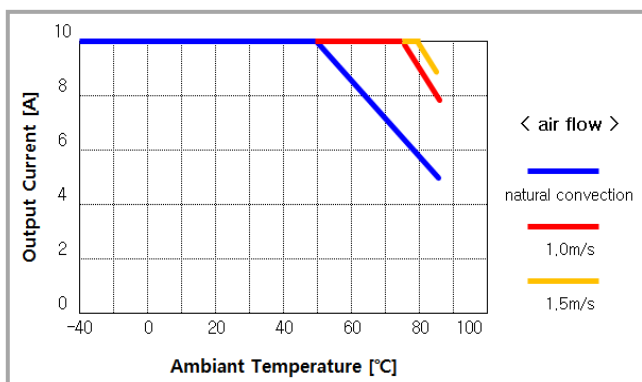

< Vo : 0.8V - 2.75V >

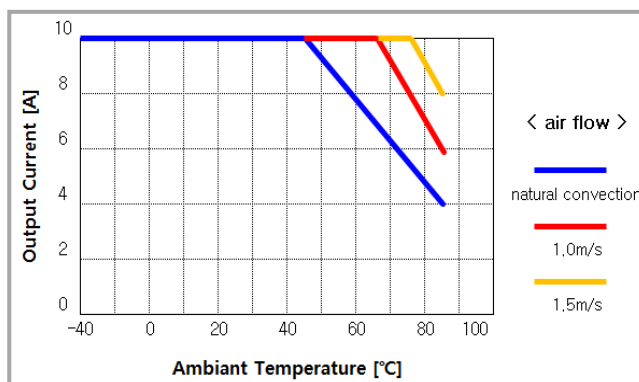

< Vo : 3.3V - 5.5V >

6. Characteristic data

6.1. Efficiency Curve

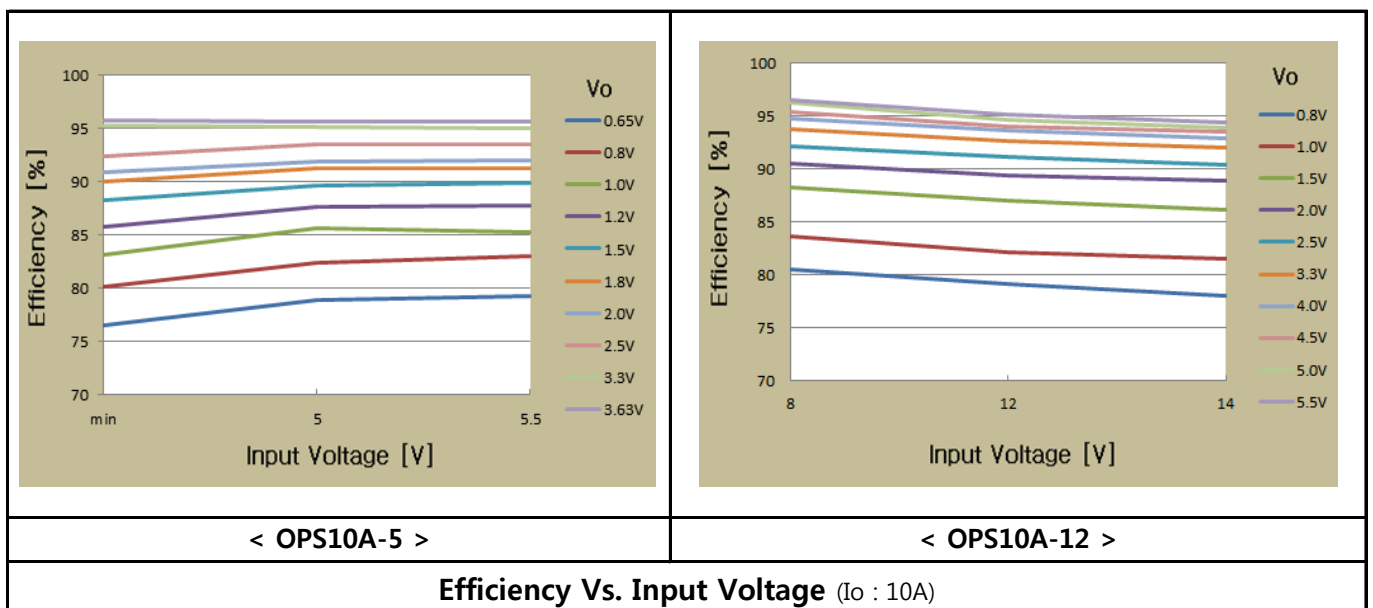
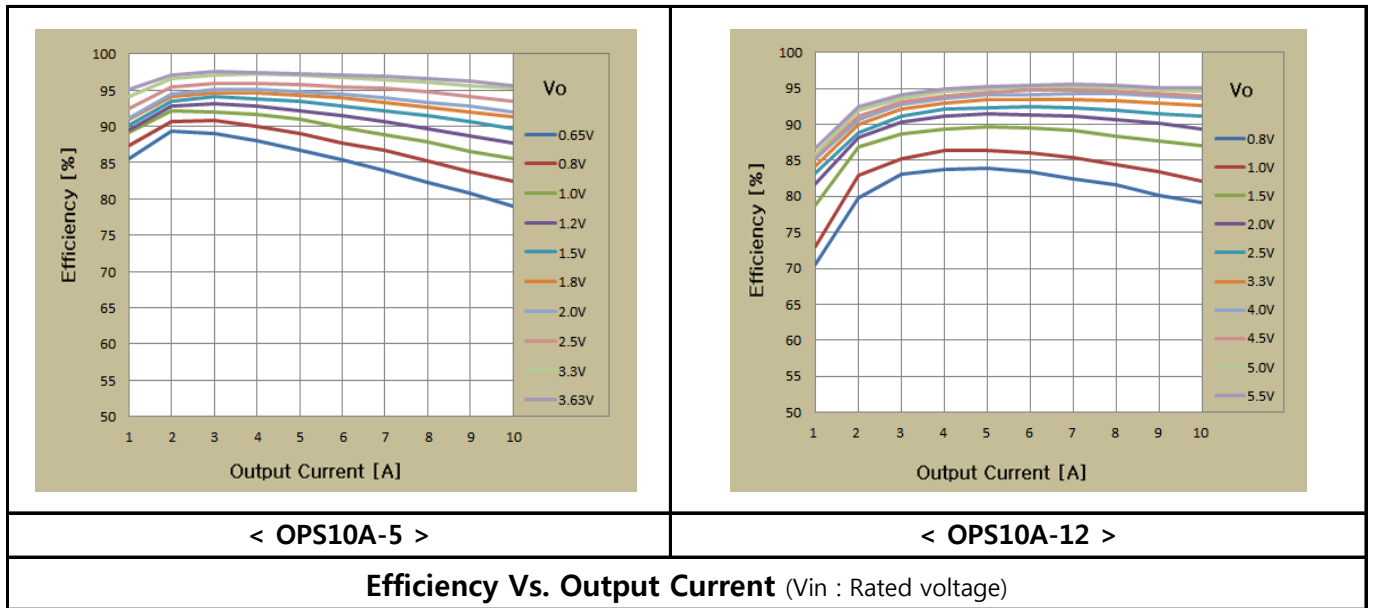

6.2. Start-up waveform by the Input Voltage

6.2.1. OPS10A-5

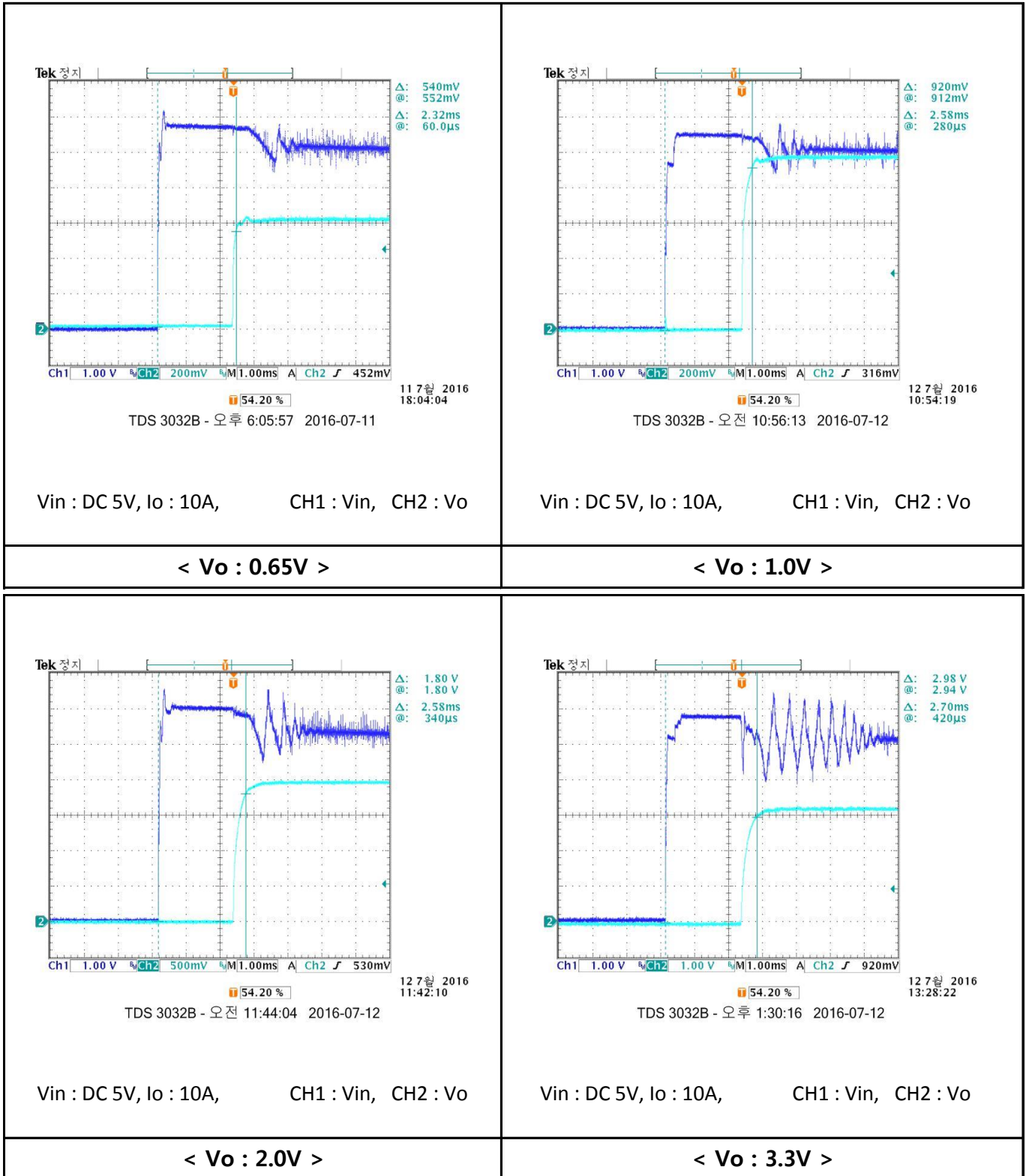

6.2.2. OPS10A-12

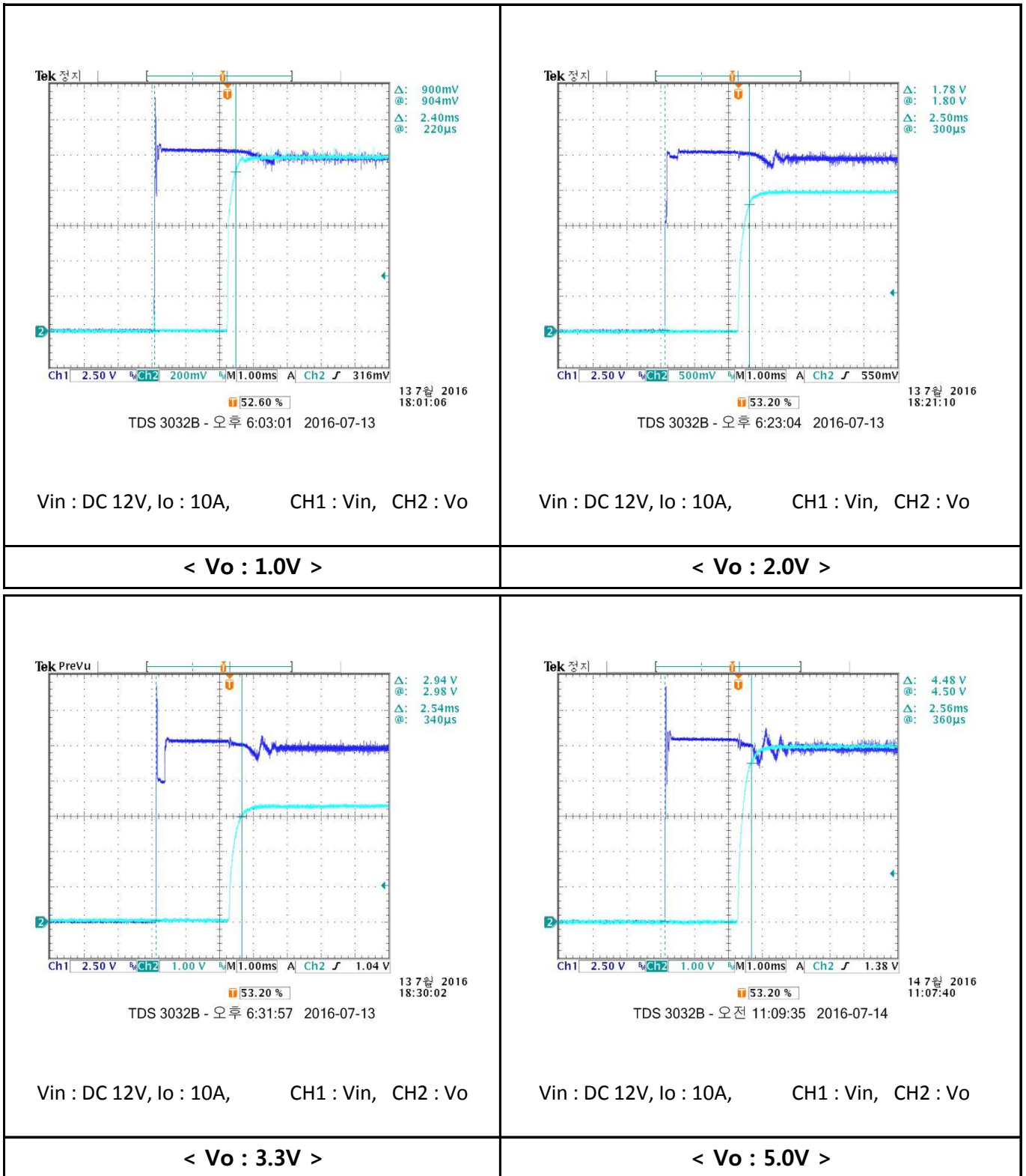

6.3. Start-up waveform by the 'CNT' pin with prebias

6.3.1. OPS10A-5

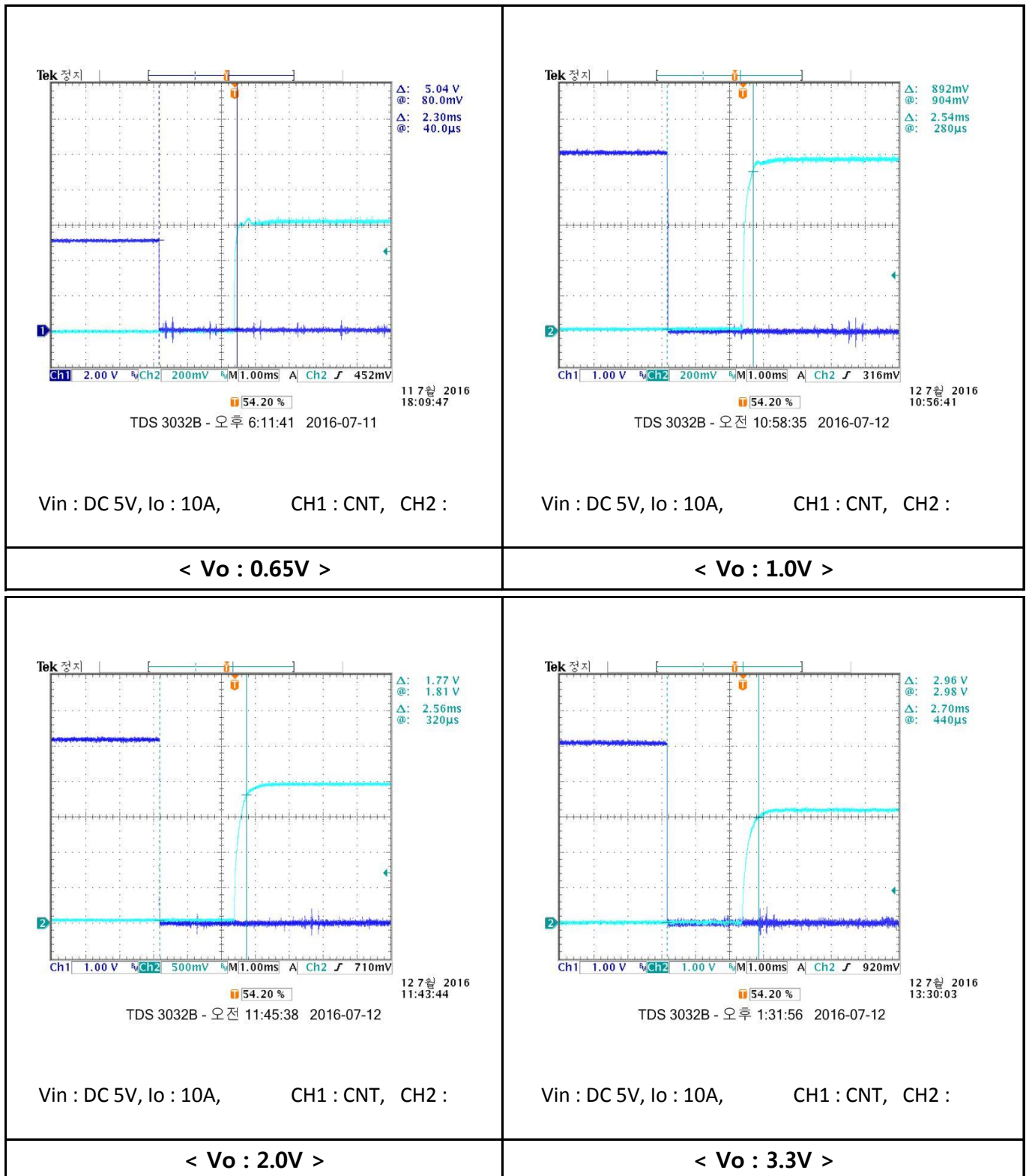

6.3.2. OPS10A-12

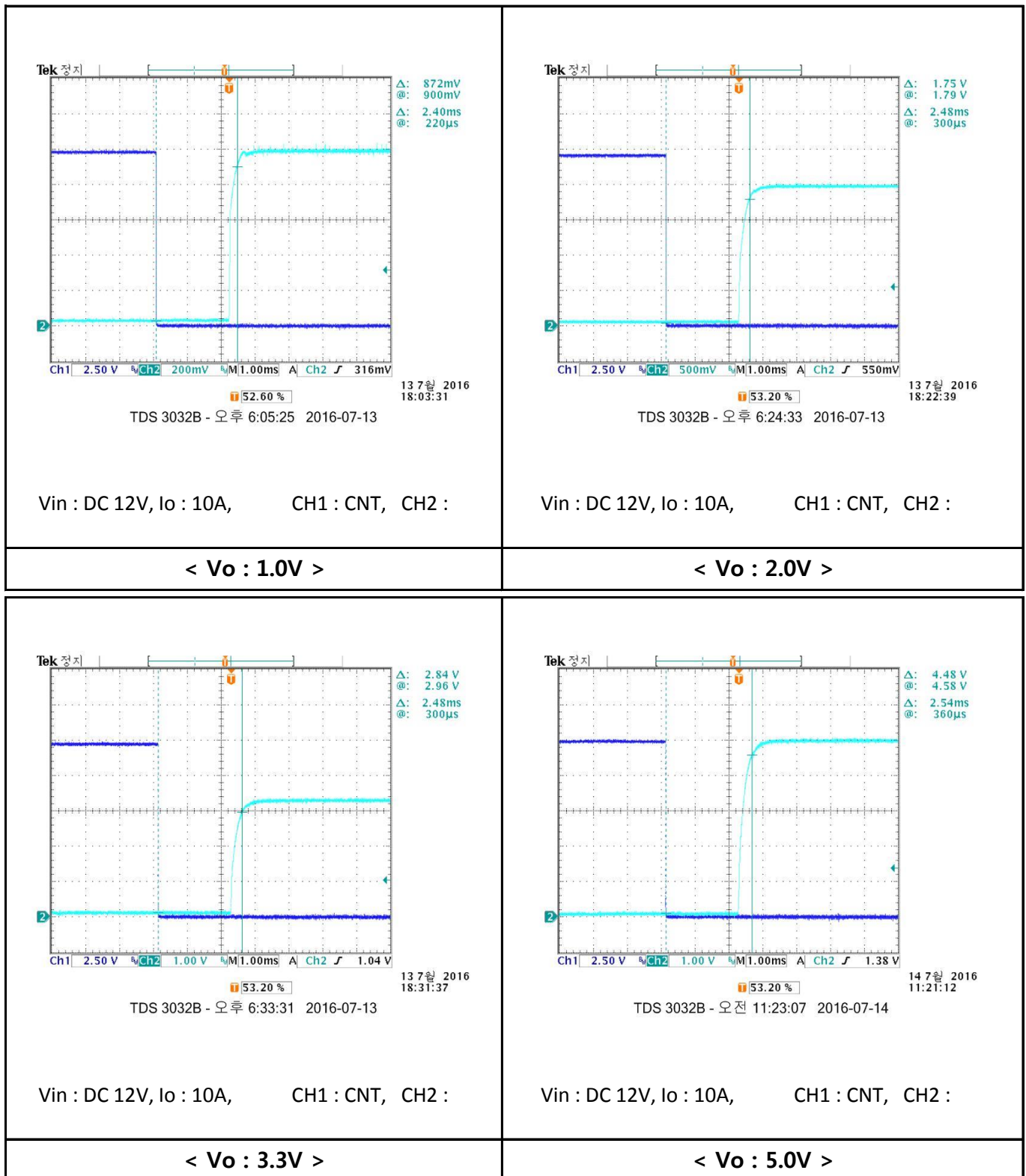

6.4. Transient response 50% - 100% step load change

6.4.1. OPS10A-5 (I_o : 10A -> 5A)

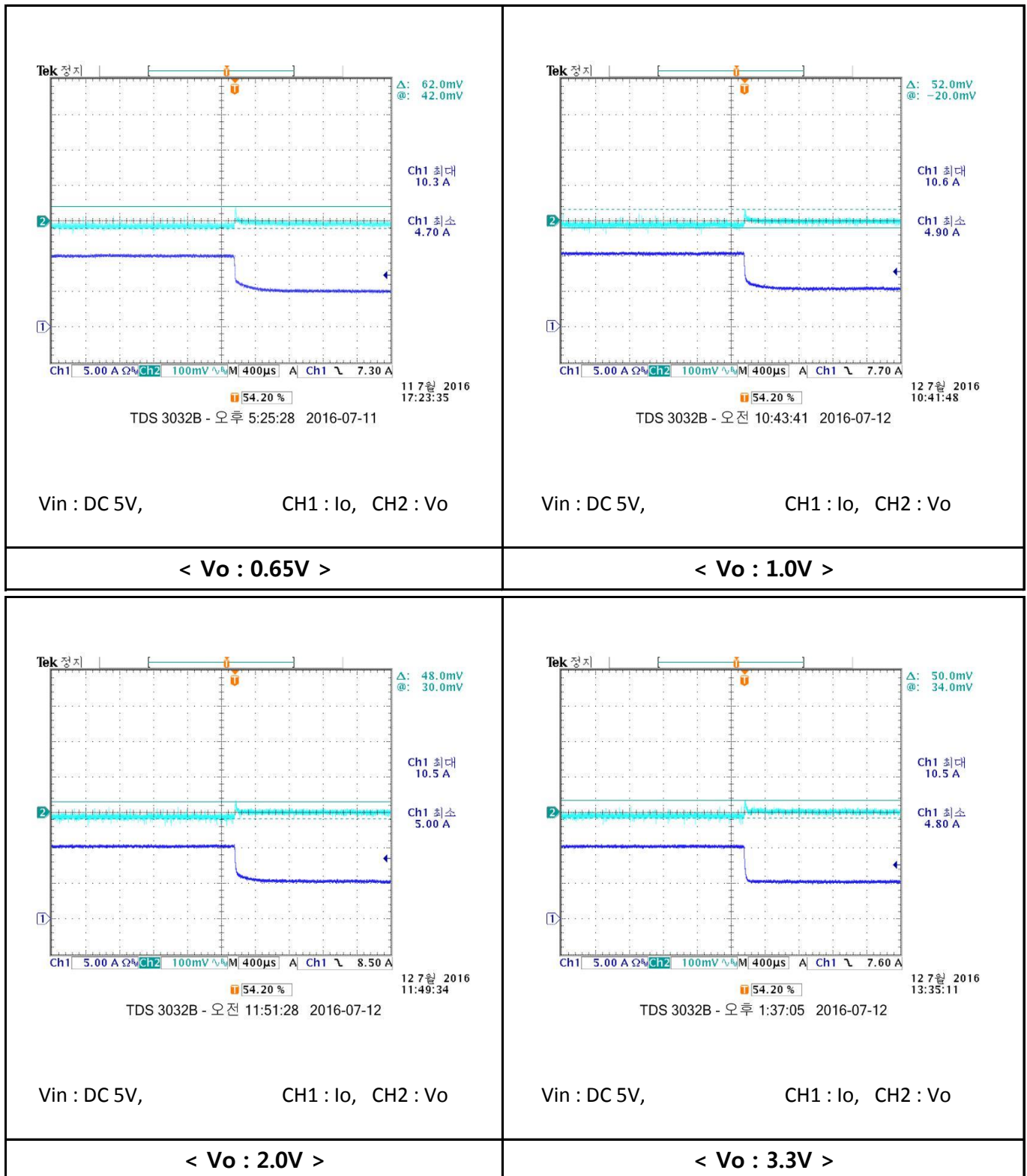

6.4.2. OPS10A-5 (Io : 5A -> 10A)

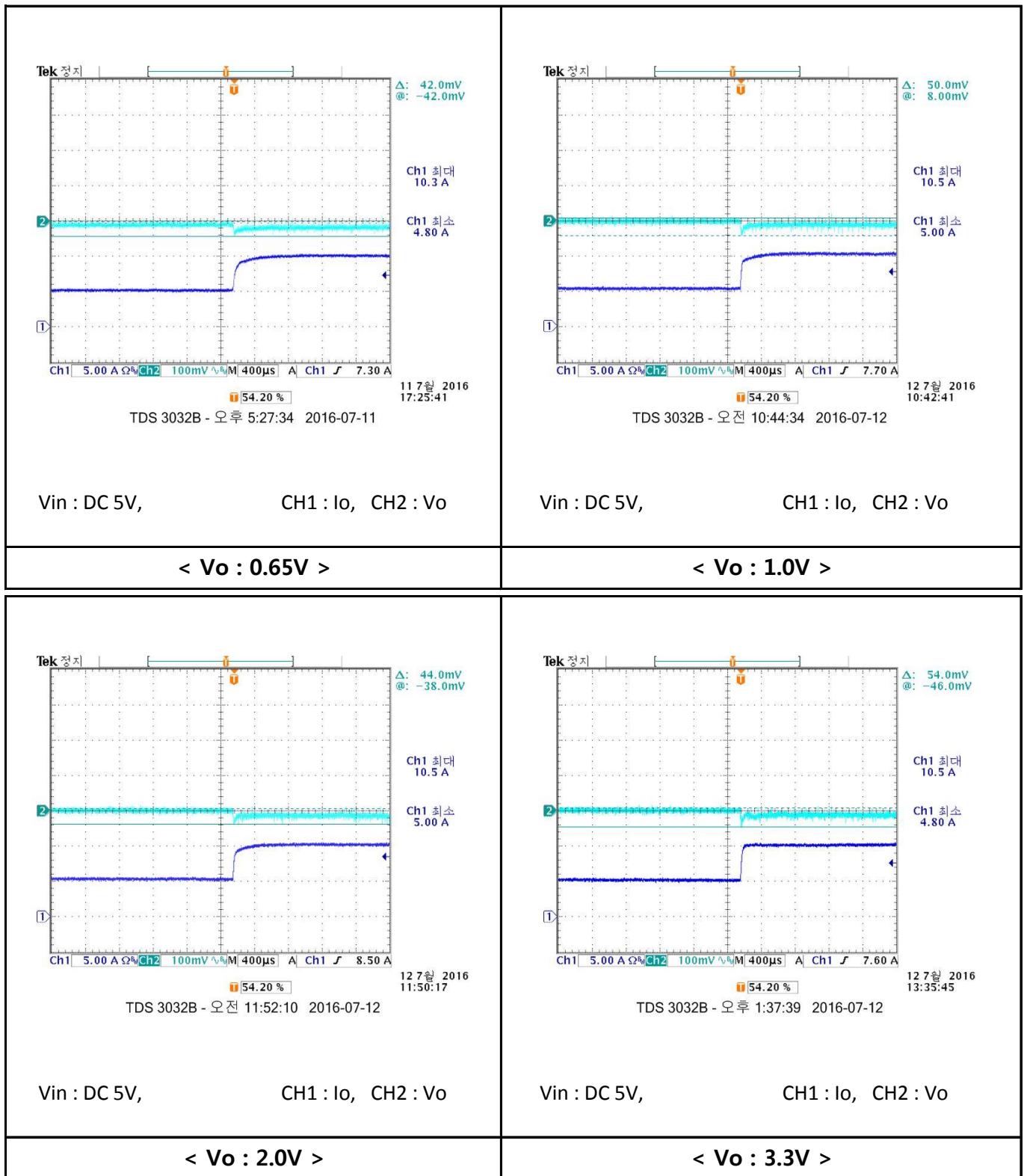

6.4.3. OPS10A-12 (Io : 10A -> 5A)

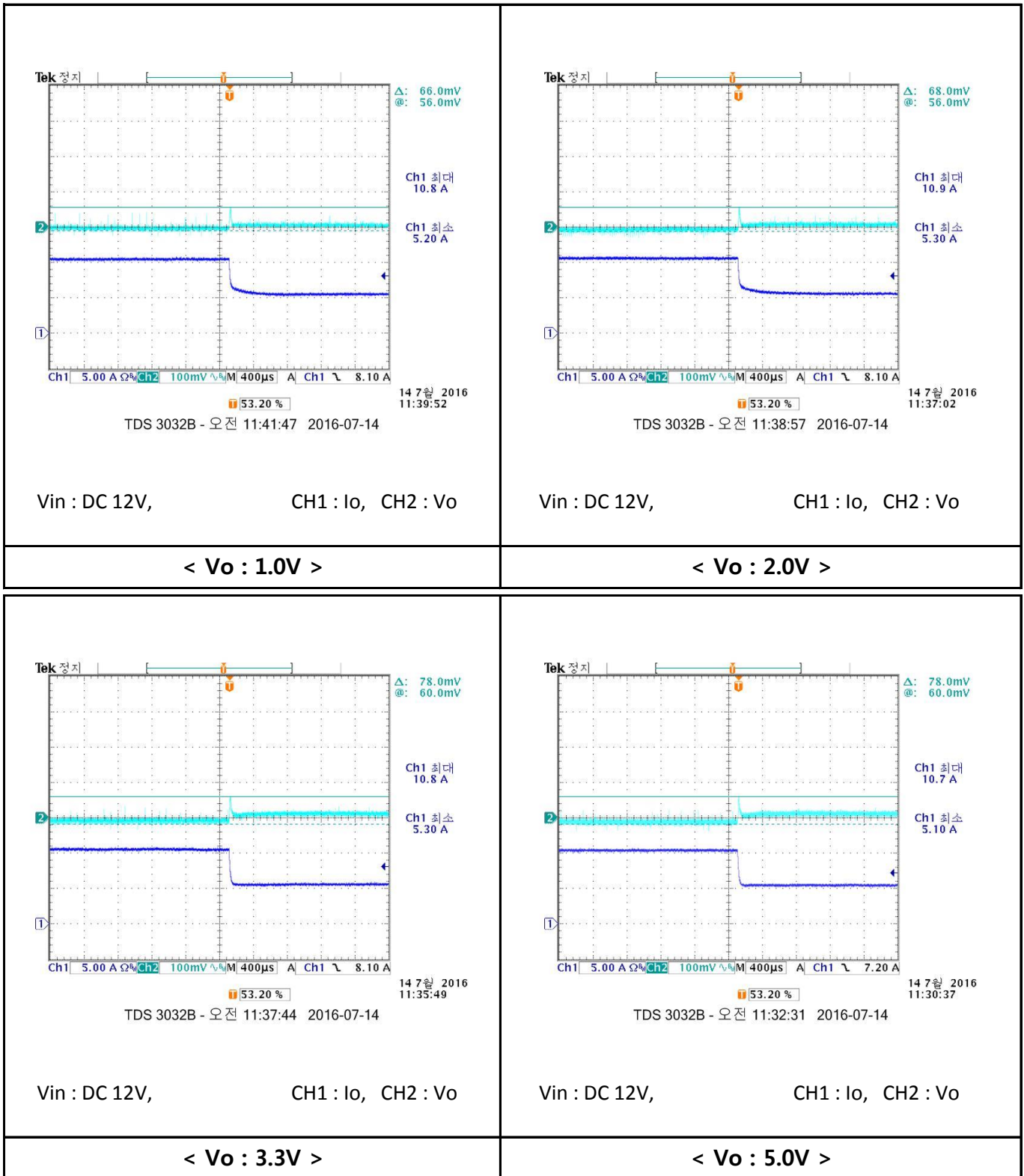

6.4.4. OPS10A-12 (Io : 5A -> 10A)

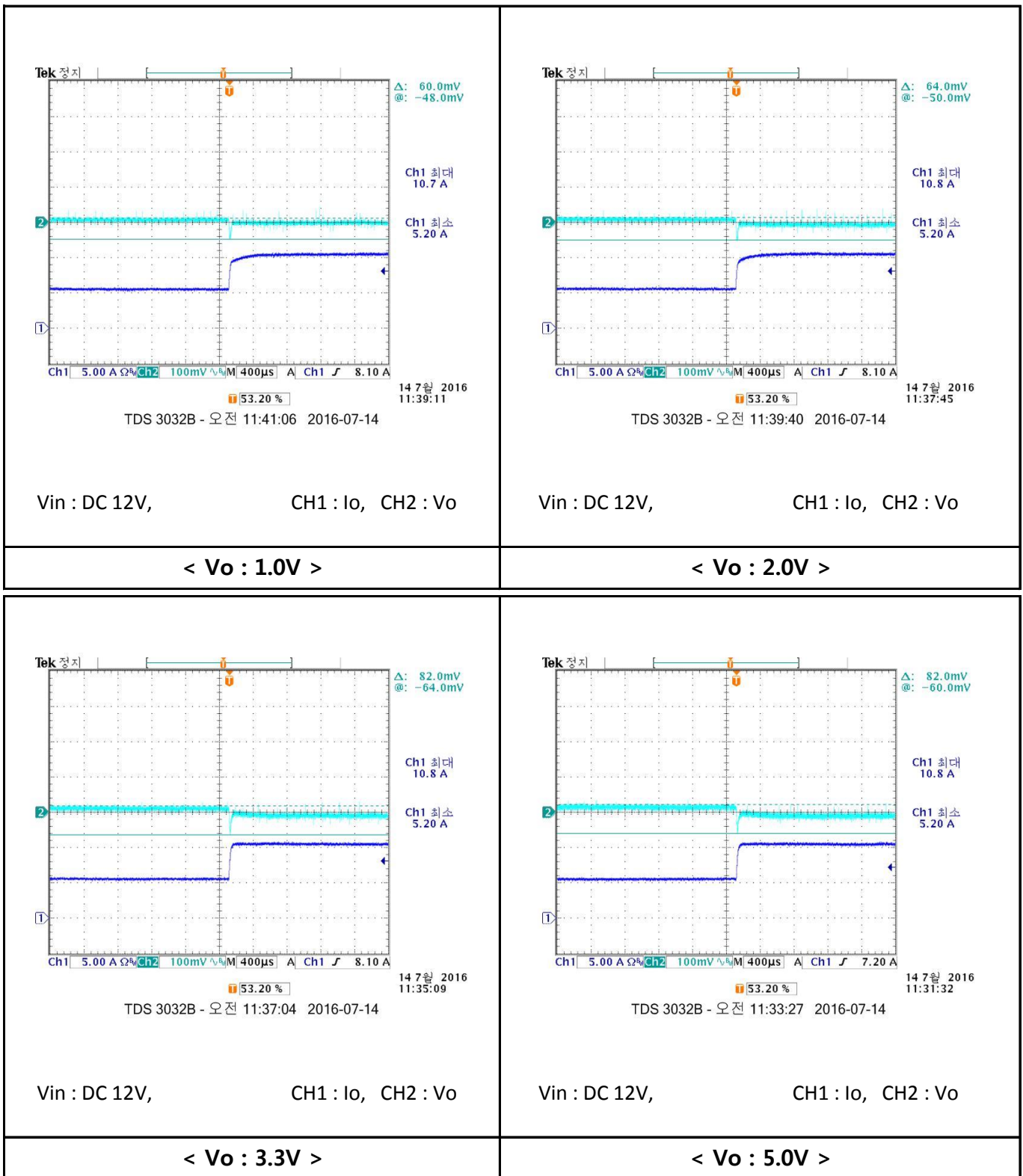

6.5. Input Reflected Ripple & Noise

6.5.1. OPS10A-5

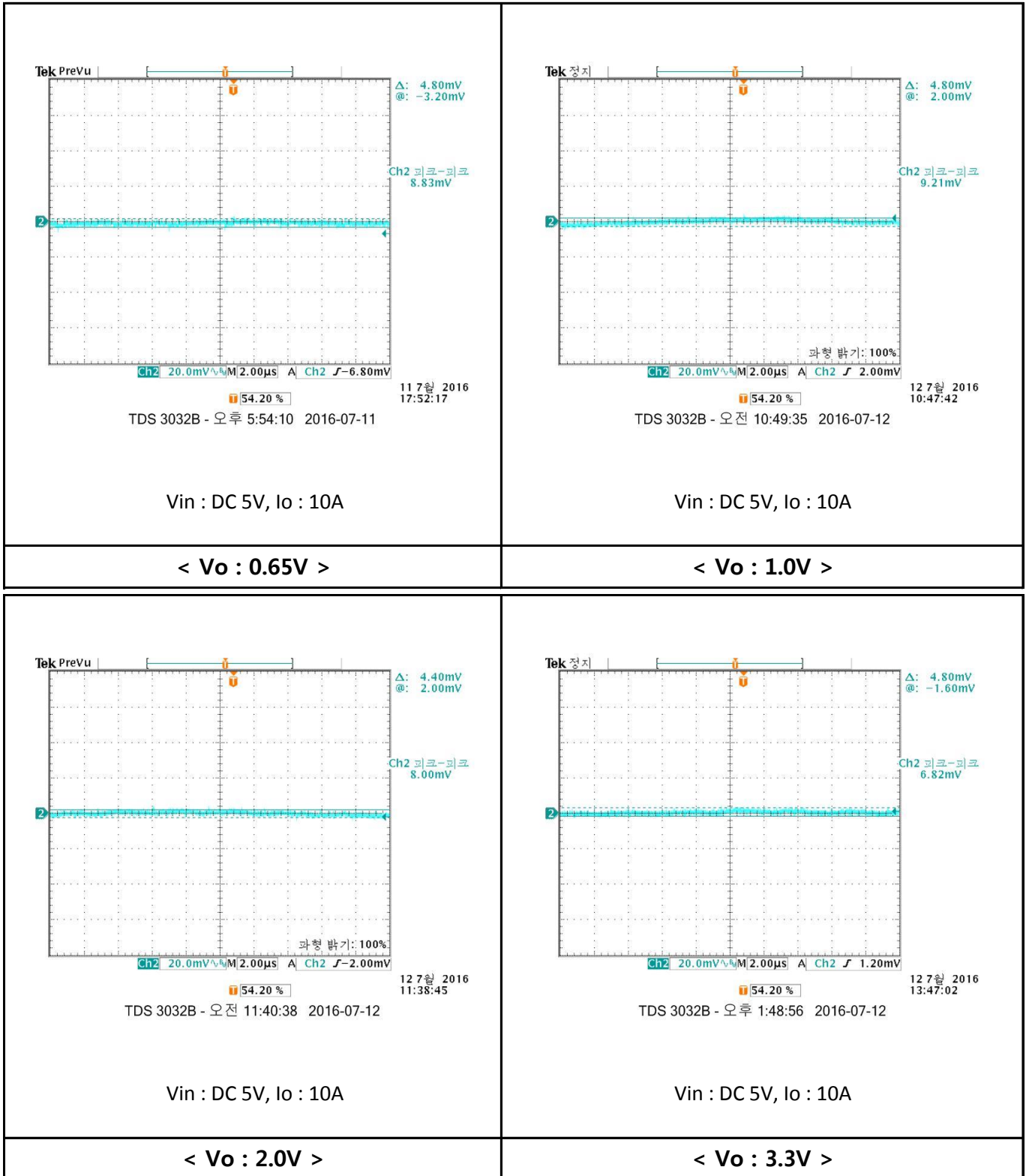

6.5.2. OPS10A-12

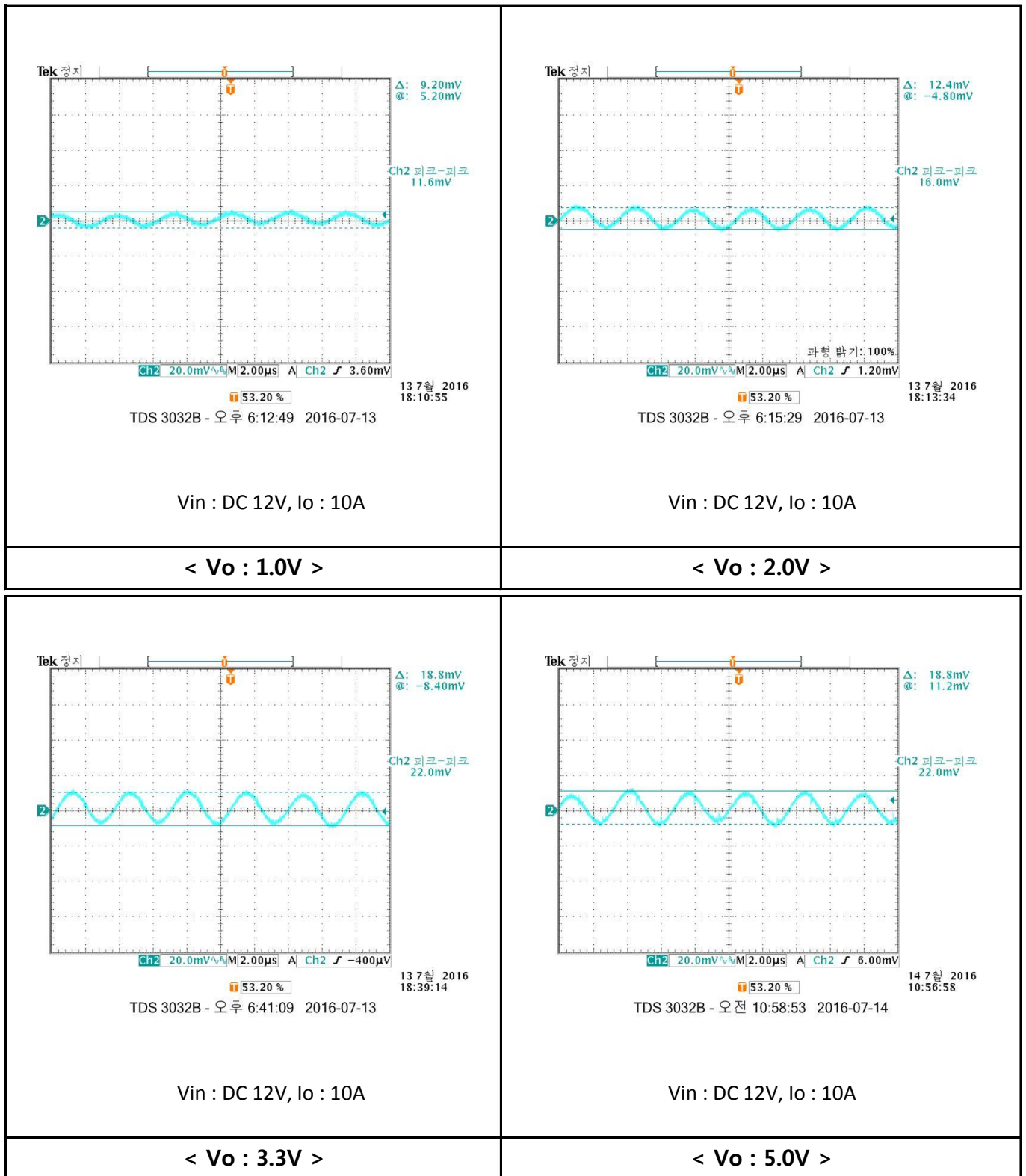

6.6. Output Ripple & Noise

6.6.1. OPS10A-5

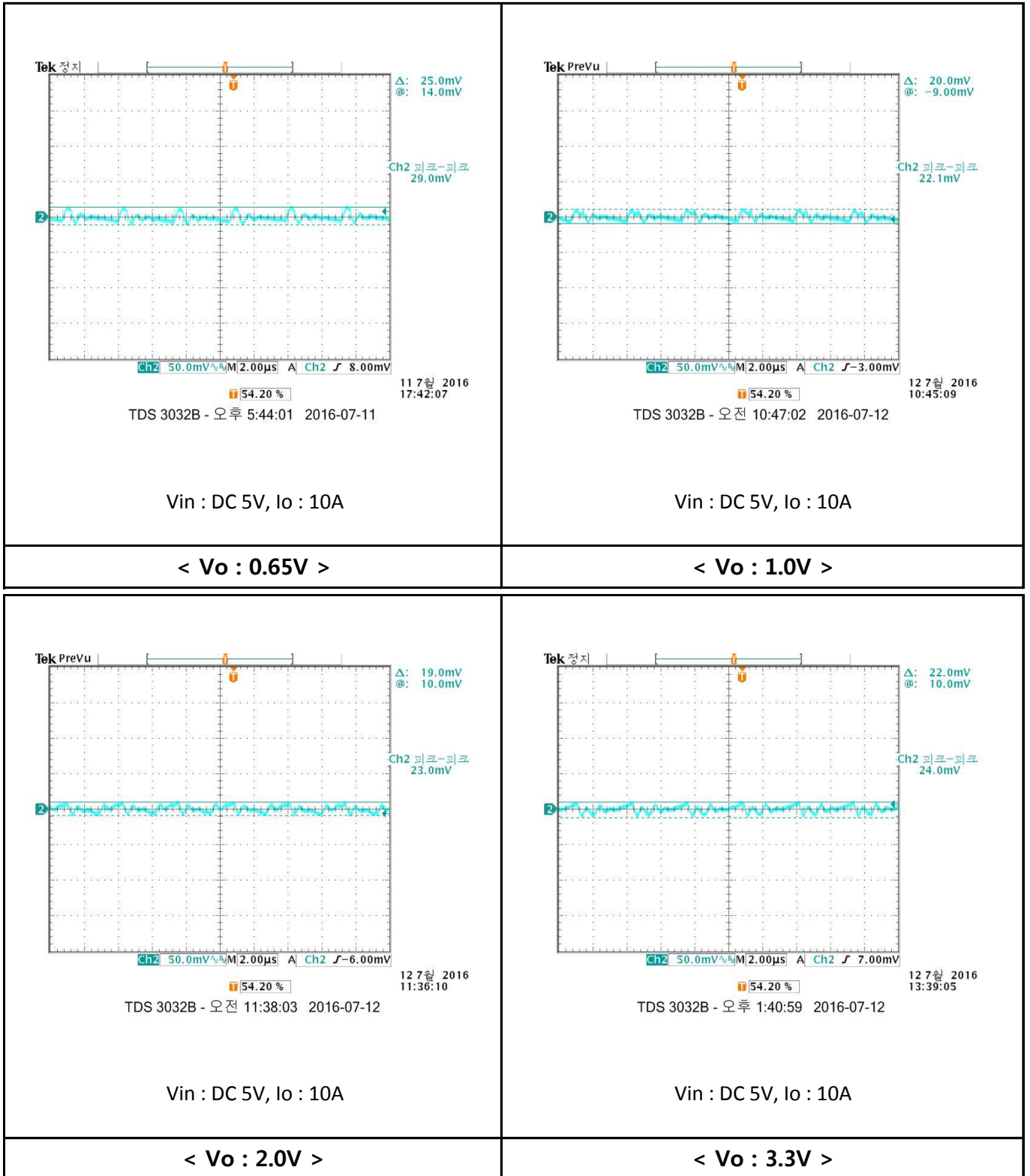

6.6.2. OPS10A-12

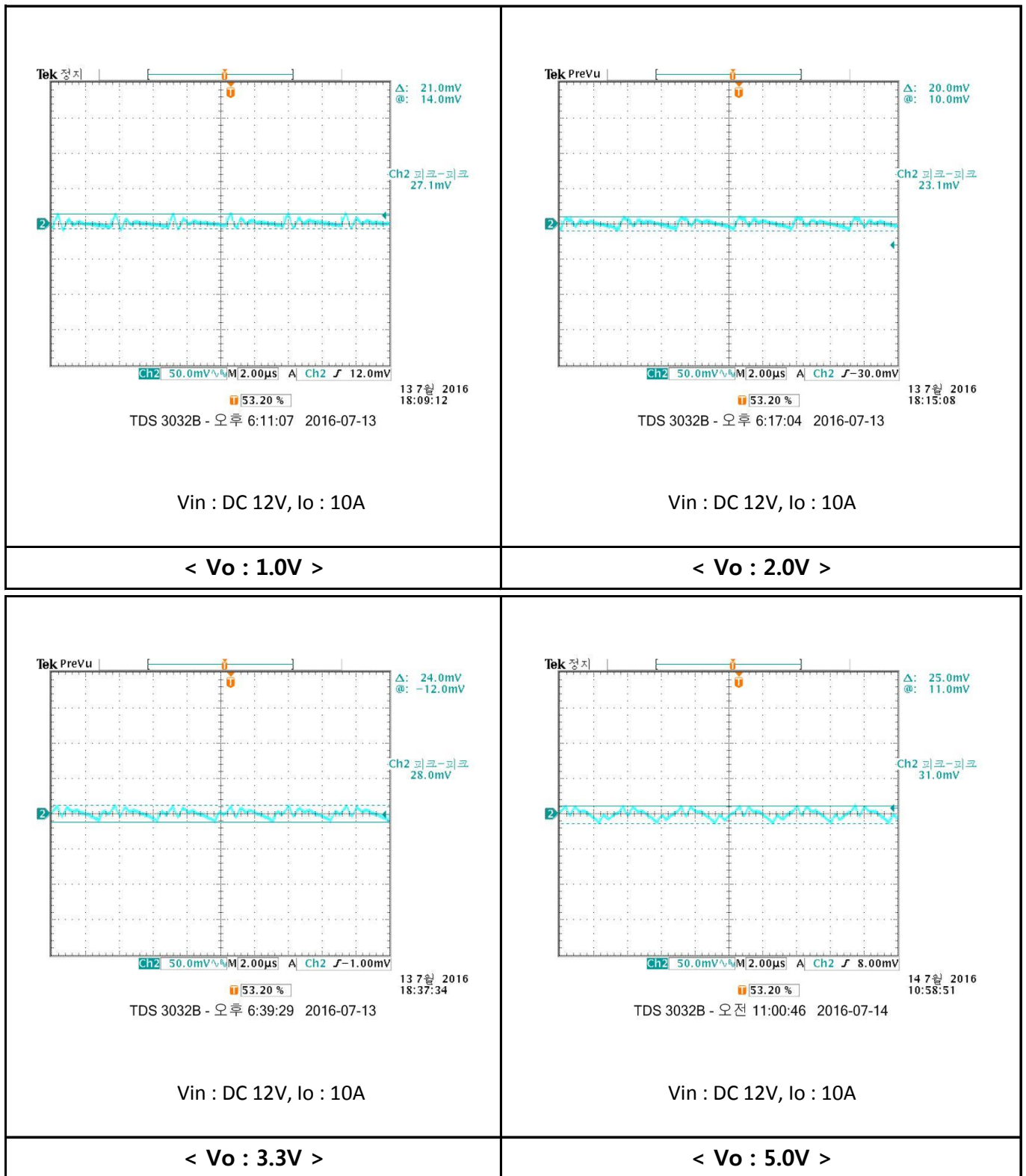

- Reliability Data

1. MTBF

Calculating Reliable Values of MTBF.

Calculated based on part count reliability projection of MIL-HDBK-217F individual failure rates λg is given to each part and MTBF is calculated by the count of each part.

Method is :

$$MTBF = \frac{10^6}{\sum_{i=1}^n Ni(\lambda g \cdot \pi Q)_i} = \frac{10^6}{\lambda_{equip}} \quad [\text{hours}]$$

For a given equipment environment where :

λ_{equip} = Total equipment failure rate (Failures / 10^6 Hours)

λg = Generic failure rate for the i th generic part (Failures / 10^6 Hours)

πQ = Quality factor for the i th generic part ($\pi Q = 1$)

Ni = Qty of i th generic part

n = Number of different generic part categories in the equipment

	PART	Number	Failure Rate	Failure Rate * n
1	Logic IC	1	0.015	0.0150000
2	FET	3	0.012	0.0360000
3	Voltage Regulaor	0	0.002	-
4	Diode (Zener)	0	0.002	-
5	Diode (FRD)	0	0.069	-
6	Diode (SBD)	1	0.027	0.0270000
7	Bridge Diode	0	0.066	-
8	LED	0	0.00023	-
9	Varistor	0	0.0013	-
10	Photo-coupler	0	0.07	-
11	Thyristor	0	0.0022	-
12	Elec.- Cap.	0	0.019	-
13	Ceramic Cap.	0	0.026	-
14	MLCC	13	0.053	0.6890000
15	Choke coil	1	0.00022	0.0002200
16	Switching transformer	0	0.0042	-
17	Line Filter	0	0.0044	-
18	Resistor	9	0.0024	0.0216000
19	Resistor Variable	0	0.0024	-
20	Thermister	0	0.0019	-
21	Connertor	2	0.052	0.1040000
22	Soldering Point	87	0.0078	0.6786000
23	PCB	1	0.37	0.3700000
24	Fuse	0	0.01	-
Total Equipment Failure Rate (λ_{equip})				1.9414200
MTBF = $10^6 / \lambda_{equip}(F/T)$				515,086.895
MTBF \cong 510,000[Hours]				

2. Environmental Stress Test(EST)

The purpose of the environment stress test is to ensure reliability by setting in advance the following environment and verified.

- transport process and conservation status
- environmental change conditions that can be applied to the product from the process of the end-user

Test cycle consists of 10 segments(total 100 hours). Test results of all segments must meet the specifications. (refer to Fig.1 & Table1)

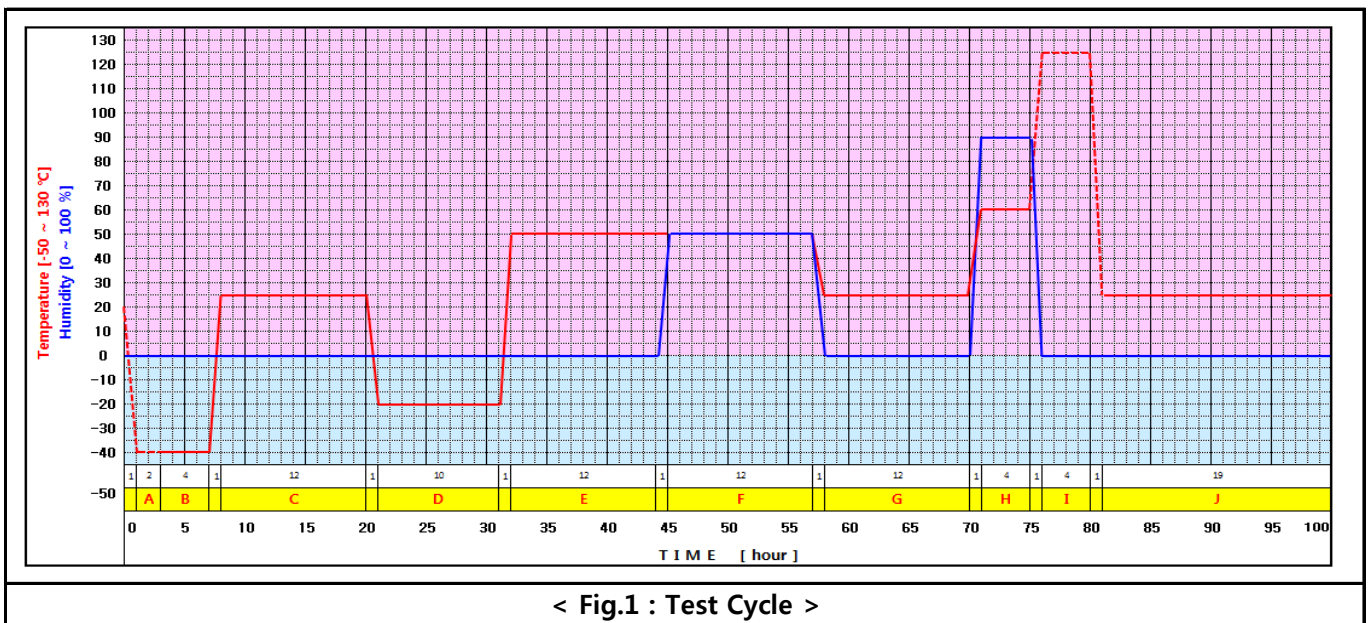

Segment	Time	Temp.	Humidity	Description	Input 'SW'
A	2 hours	-40°C	0%	Low temperature storage	off
B	4 hours	-40°C	0%	Low temperature operation	on
C	12 hours	25°C	0%	Room temperature operation	on
D	10 hours	-20°C	0%	Low temperature operation	on
E	12 hours	50°C	0%	High temperature operation	on
F	12 hours	50°C	50%	High-temperature & humidity operation	on
G	12 hours	25°C	0%	Room temperature operation	on
H	4 hours	60°C	90%	High-temperature & humidity operation	on
I	4 hours	125°C	0%	High temperature storage	off
J	19 hours	25°C	0%	Room temperature operation	on

< Table1 : Segment Description >

2.1. Environmental Stress Test Results

- a. Test Sample : OPS10A-5 (Vo : 3.3V)
- b. 100 hours in one cycle test graph

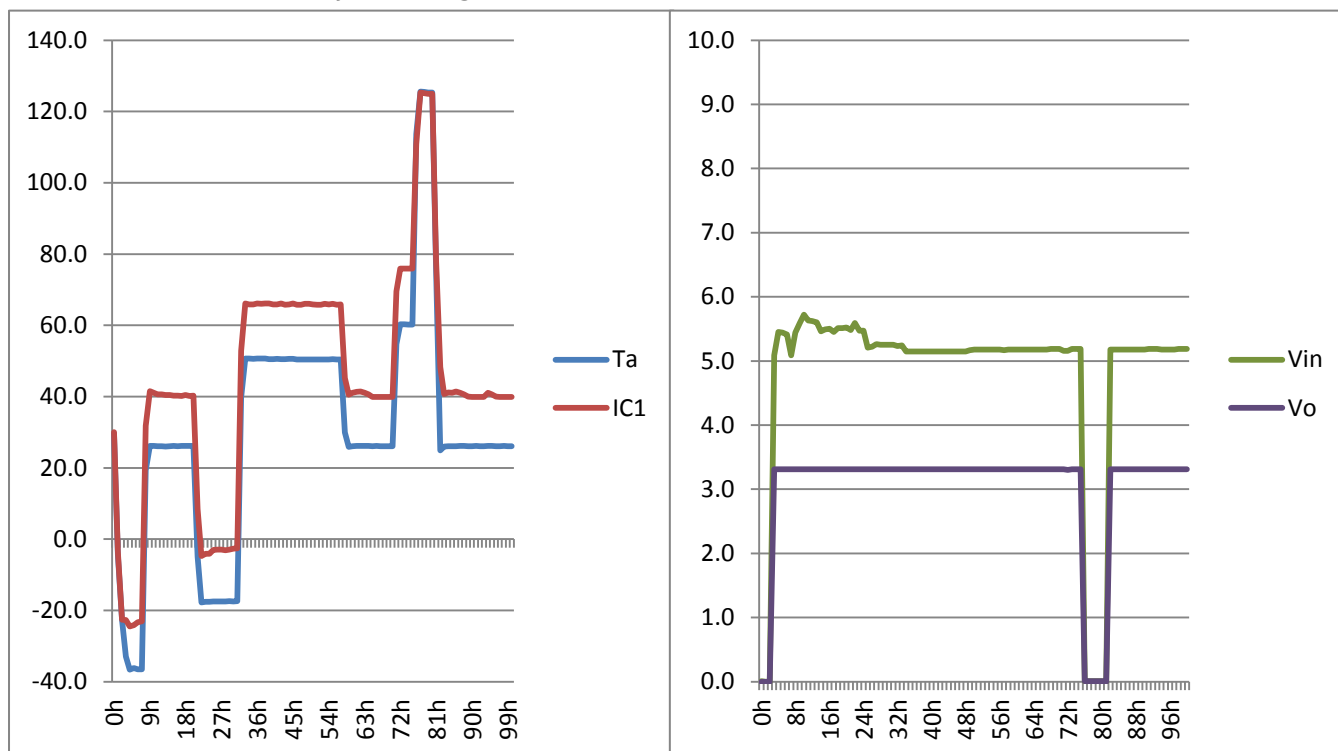

- c. Characteristics test results (@ Input Voltage : 5VDC)

Segment	Test Time	T _{amb./Humi.}	Output Voltage	Start up	Ripple / Noise	Output Load Condition
A	3h	-40°C / 0%	3.310V	OK	10 / 18 [mVp-p]	100% Load
B	9h	25°C / 0%	3.31V	OK	12 / 21 [mVp-p]	100% Load
C	24h	-20°C / 0%	3.31V	OK	12 / 18 [mVp-p]	100% Load
D	33h	50°C / 0%	3.31V	OK	13 / 20 [mVp-p]	100% Load
E	48h	50°C / 50%	3.31V	OK	15 / 18 [mVp-p]	100% Load
F	58h	25°C / 0%	3.31V	OK	15 / 20 [mVp-p]	100% Load
G	72h	60°C / 90%	3.31V	OK	15 / 18 [mVp-p]	100% Load
H	81h	25°C / 0%	3.31V	OK	12 / 18 [mVp-p]	100% Load
I	100h	25°C / 0%	3.31V	OK	12 / 20 [mVp-p]	100% Load
Test Result			Pass	Pass	Pass	

- d. Test Sample : OPS10A-12 (Vo : 5V)
- e. 100 hours in one cycle test graph

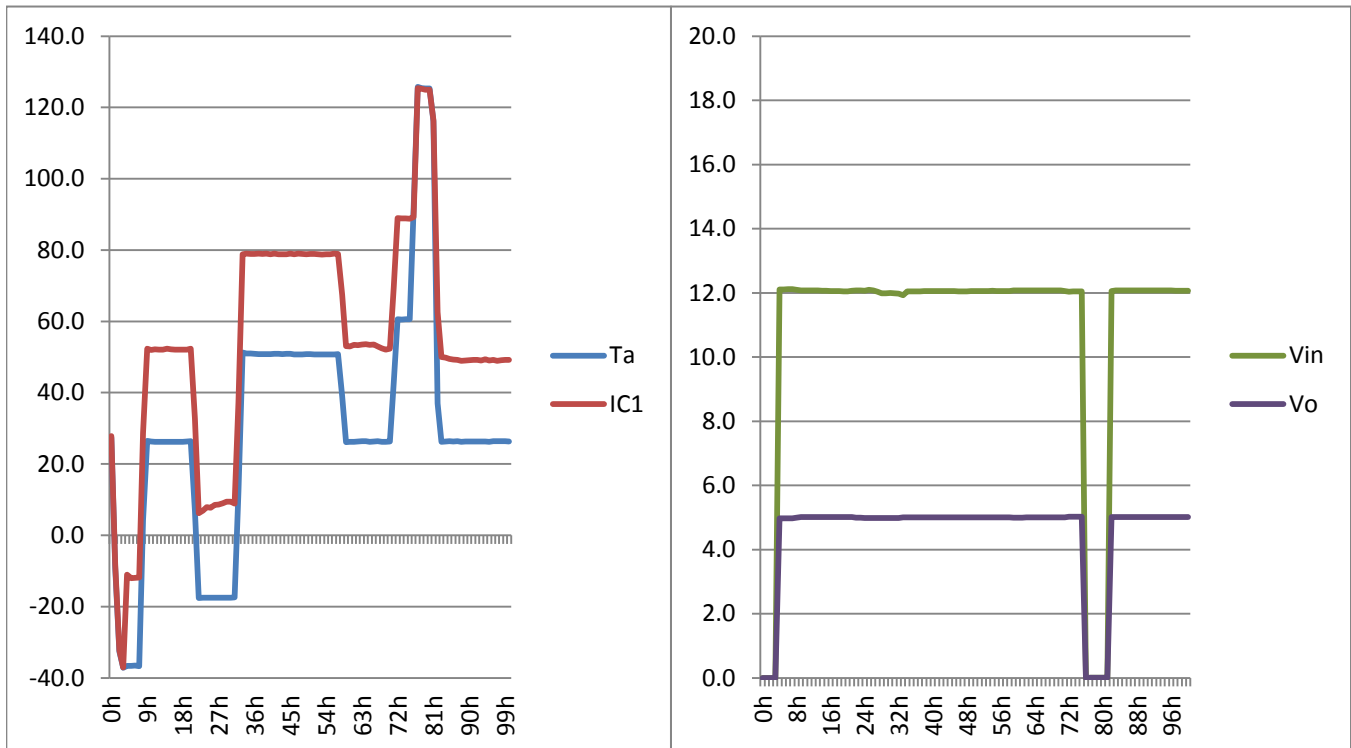

f. Characteristics test results (@ Input Voltage : 12VDC)

Segment	Test Time	T _{amb./Humi.}	Output Voltage	Start up	Ripple / Noise	Output Load Condition
A	3h	-40°C / 0%	4.97V	OK	21 / 42 [mVp-p]	100% Load
B	9h	25°C / 0%	5.01V	OK	18 / 43 [mVp-p]	100% Load
C	24h	-20°C / 0%	4.98V	OK	23 / 45 [mVp-p]	100% Load
D	33h	50°C / 0%	5.00V	OK	19 / 44 [mVp-p]	100% Load
E	48h	50°C / 50%	5.00V	OK	20 / 44 [mVp-p]	100% Load
F	58h	25°C / 0%	5.00V	OK	20 / 44 [mVp-p]	100% Load
G	72h	60°C / 90%	5.02V	OK	21 / 43 [mVp-p]	100% Load
H	81h	25°C / 0%	5.01V	OK	19 / 43 [mVp-p]	100% Load
I	100h	25°C / 0%	5.01V	OK	20 / 43 [mVp-p]	100% Load
Test Result			Pass	Pass	Pass	

- Application Sheet

1. Basic Connection

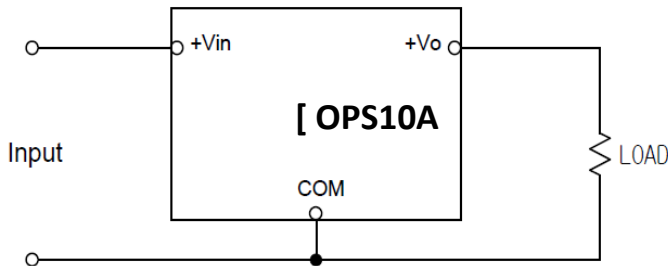

The figure below shows the recommended circuit for reducing the ripple & noise of the input and output voltage. (recommend Low ESR type capacitor)

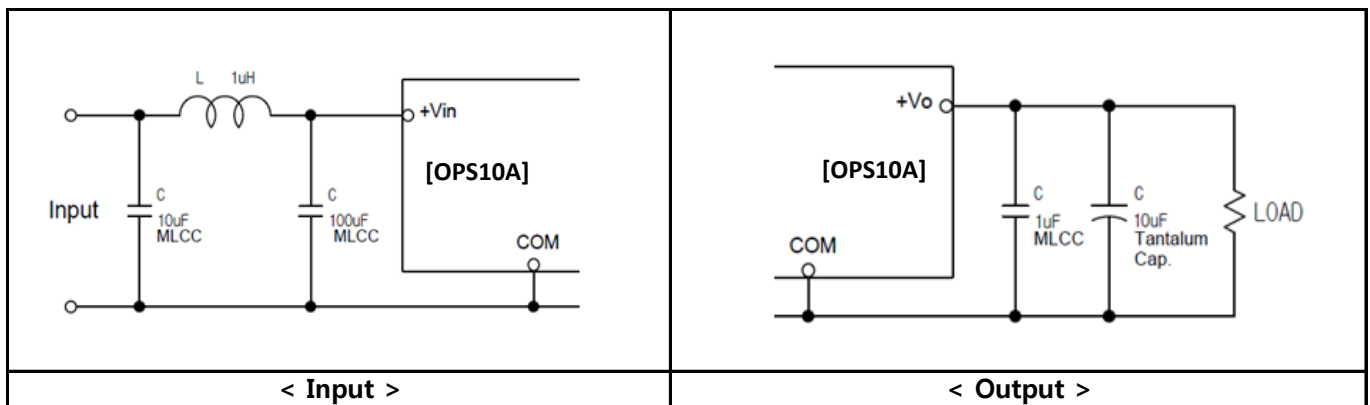

2. Input Section

- Input fuse

OPS10A series does not have an internal fuse. To ensure safe operation, an external fuse(Regular or Slow Blow type) is recommended.

	OPS10A-5	OPS10A-12
	10A	10A

- Unstable Input

Input voltage is comprised of both the DC voltage(average rectified voltage)and the peak to peak ripple voltage. Peak to peak ripple voltage should be minimized so that the input voltage is within the standard input voltage range as follows.

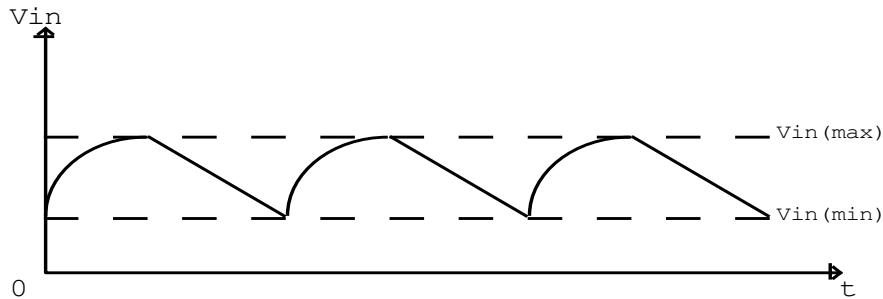

< Unstable Input >

- Remote On/Off Control(CNT)

OPS10A series offers remote on / off control (CNT) function. When the CNT pin is low level or floating, output is turned on. When the CNT pin is high level, output is turned off. (low dissipation : $I_{in} \leq 3mA$)

The signal level of CNT input is defined with respect to the common ground.

Standard of CNT function is active-low. When operate active-high, need to external parts.

Please refer to following tables and figures.

CNT level	Description	Output
Low level	DC 0V – 1.2V or open	ON
High level	DC 1.8V – Vin	OFF

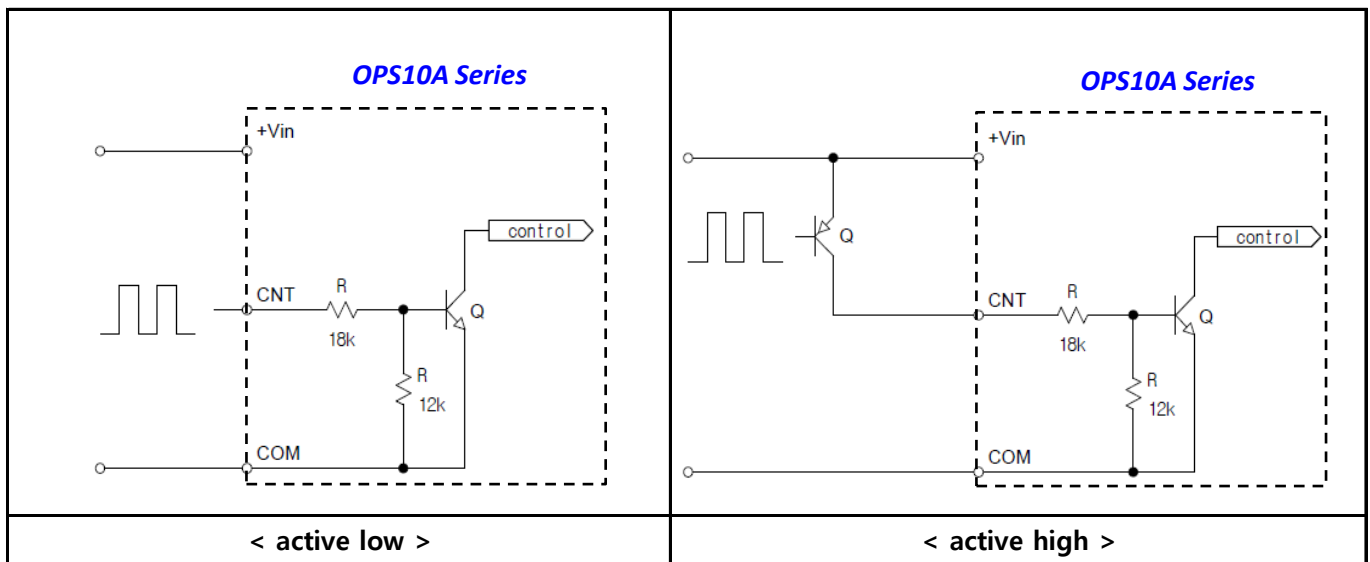

3. Output Section

- Output Voltage Adjustment (TRM)

OPS10A series offers a wide range of variable output voltage. Wide output voltage variation range is an important feature that can improve the inconvenience of having to purchase a different output voltage module. The output voltage of OPS10A-5 can be adjusted from 0.65V to 3.63V by an external resistor R_T . If R_T is opened, the output voltage is 0.65V. The output voltage of OPS10A-12 can be adjusted from 0.8V to 5.5V by an external resistor R_T . If R_T is opened, the output voltage is 0.8V.

< External resistor(R_T) connecting & calculating method >

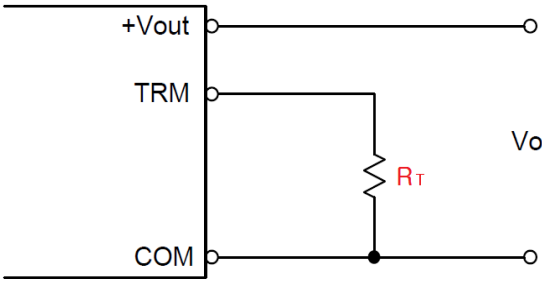

$$R_T = \frac{6}{V_o - 0.65} \text{ [k}\Omega\text{]} \quad (\text{OPS10A-5})$$

$$R_T = \frac{6}{V_o - 0.8} \text{ [k}\Omega\text{]} \quad (\text{OPS10A-12})$$

< Vo adj. Range >		
Model No.	Vin	Vo
OPS10A-5	DC 3.5V - 4.5V	DC 0.65V - 2.75V
	DC 4.5V - 5.5V	DC 0.65V - 3.63V
OPS10A-12	DC 8V - 14V	DC 0.8V - 5.5V

< External Resistor Values for setting output voltage >

OPS10A-5			OPS10A-12		
Vo	R_T	Vin	Vo	R_T	Vin
0.65V	open	DC 3.5V - 5.5V	0.8V	open	DC 8.0V - 14.0V
0.8V	40.2k Ω		1.0V	30.0k Ω	
1.0V	16.9k Ω		1.5V	8.66k Ω	
1.2V	11.0k Ω		2.0V	4.99k Ω	
1.5V	6.98k Ω		2.5V	3.48k Ω	
1.8V	5.23k Ω		3.3V	2.4k Ω	
2.0V	4.42k Ω		4.0V	1.87k Ω	
2.5V	3.24k Ω		4.5V	1.62k Ω	
3.3V	2.26k Ω	DC 4.5V - 5.5V	5.0V	1.43k Ω	
3.63V	2.0k Ω		5.5V	1.3k Ω	

R_T is recommended resistor of 1% standard values to consideration of the output voltage accuracy.

- Output Ripple and Noise Measurement Method

The measurement for output ripple and noise are based on normal probe with 20MHz bandwidth scope. Please refer to following figures.

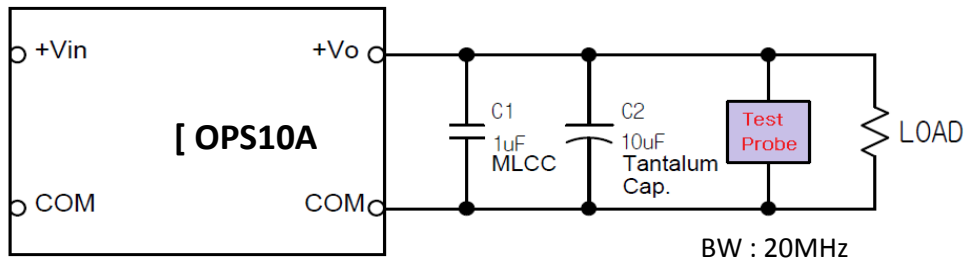

4. Protection Section

- Over Current Protection (OCP)

The OPS10A series is built into an OCP(Over Current Protection) circuit. When the OCP triggers, the output voltage will be entering hiccup mode. If overload condition is removed, the output is automatically recovered.

- Short Circuit Protection (SCP)

The OPS10A series is built into an SCP(Short Circuit Protection) circuit. When the SCP triggers, the output voltage will be entering hiccup mode. If short condition is removed, the output is automatically recovered. When the short circuit condition persists, the unit may be destroyed.

- Over temperature Protection (OTP)

The OPS10A series is built into an OTP(Over Temperature Protection). The OTP is triggered when the temperature of Tref. reaches 135 °C. When the OTP triggers, the output voltage will be shutdown. If Tref. is decreased, the output is automatically recovered. Please refer to following figures.

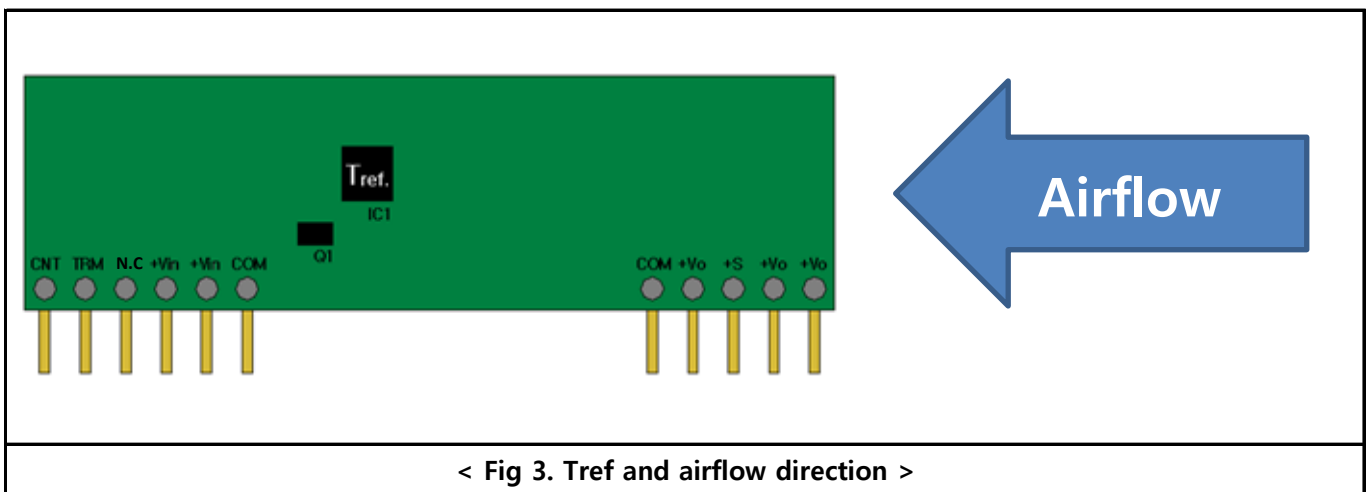

5. Environment

- Temperature

The range of ambient temperature in °C over which a module can be operated safely at either rated or derated output power. Refer to Fig 3 and derating curve as shown below.

< Derating Curve >

a. OPS10A-5 (@ Vin : 5V)

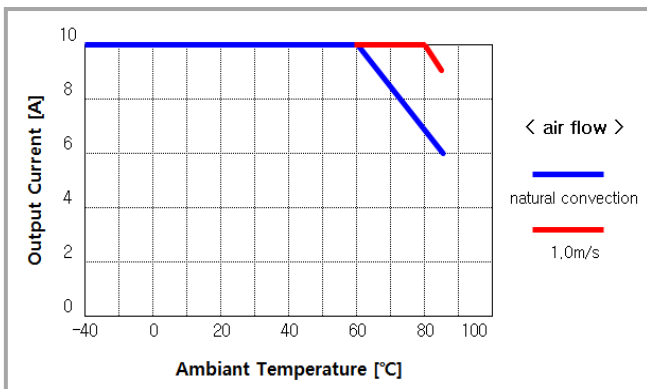

b. OPS10A-12 (@ Vin : 12V)

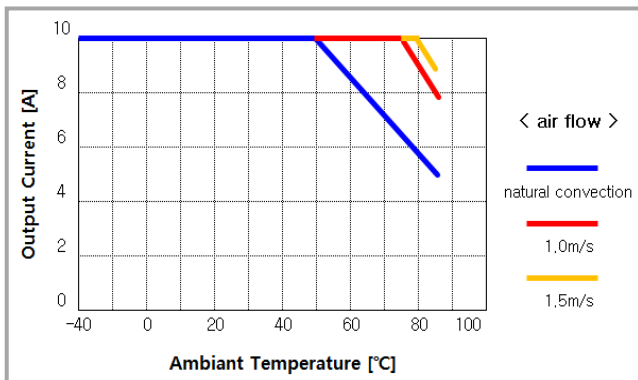

< Vo : 0.8V - 2.75V >

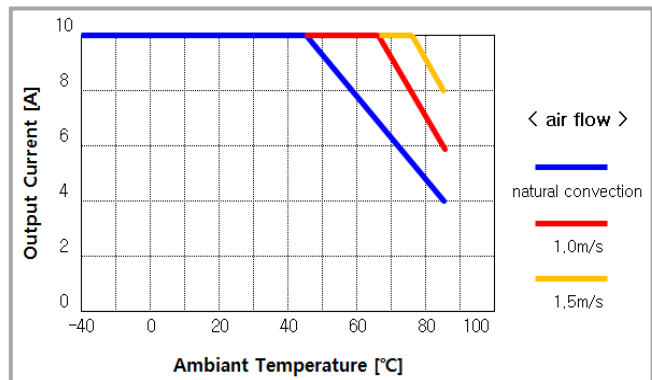

< Vo : 3.3V - 5.5V >

- Humidity

The operating humidity range is from 5% to 95%RH. (Non condensing)

6. Outline Dimensions : All dimensions are in millimeter and (inch)

Outline Dimensions <Unit : mm (inch)>

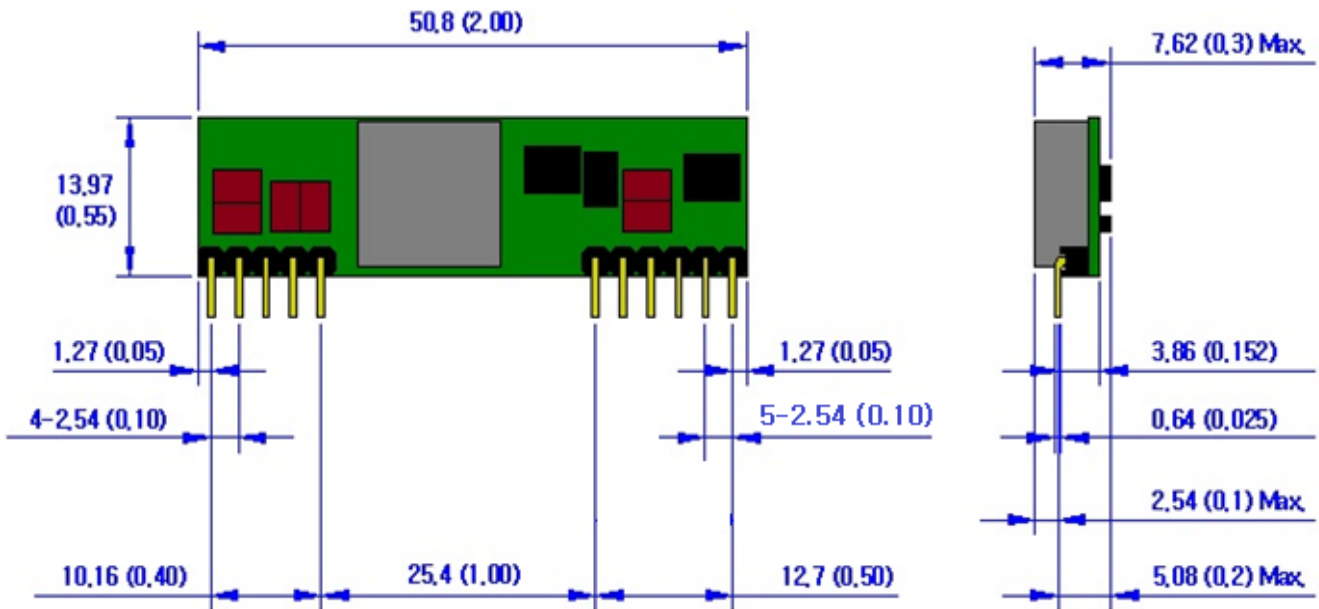

Mounting Hole <Top View>

